

VERSIA

THE MOST VERSATILE
WINDOW

Sliding window system



THERMIA[®]
BARCELONA



**Design
Comfort
Silence**

A chameleon's eyes are known for being able to move independently and asymmetrically, giving the animal a complete vision of its surroundings.

A flower opens and closes its petals depending on the position of the sun. Birds have incredible functionality in their legs, helping them to rotate in any direction.

In the animal world, versatility is undoubtedly synonymous with evolution, a touch of magic that endows the possessor with a winning hand.

The same holds true in the inanimate world. Clay, for instance, can be made into all kinds of styles and shapes. It is the basis for the construction of many architectural elements. It was the first pottery used by humans; bricks, cooking utensils, musical instruments, and art works. It serves for just about anything.

The versatility
of an object speaks of intelligence,
evolution, and perfect adaptation to
the environment.

We generate culture through objects, to which we give value and function. The window is merely another material entity to which these principles can be applied.



Adapting and improving our systems for the emerging demands and needs of the day is part of our raison d'être as a brand.

VERZIA, a window for pure, articulated designs

In projects in which we strive for harmonious lines, Thermia VERSIA guides us in articulating a clean discourse, without unnecessary ornamentation. We like to define it as a series for elegant and contemporary designs.

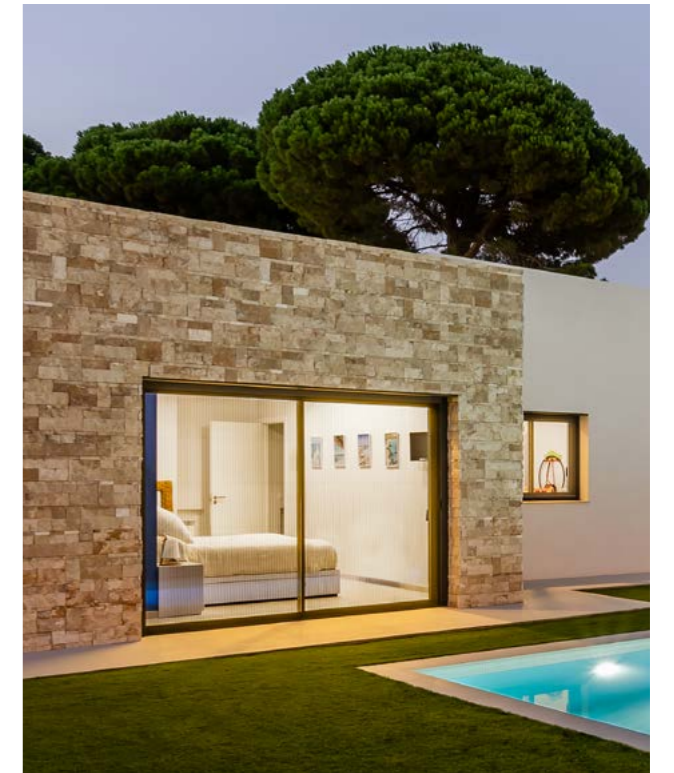

A window that dynamically adapts to the practical, aesthetic, and high-insulation requirements of an architectural proposal.

Functionality, technology, and luxury in windows



We are demanding more and more from our windows. They must be beautiful, insulate us from the outside, move smoothly, and disappear if necessary. Thermia VERSIA is this and more.

Design
Comfort
Silence

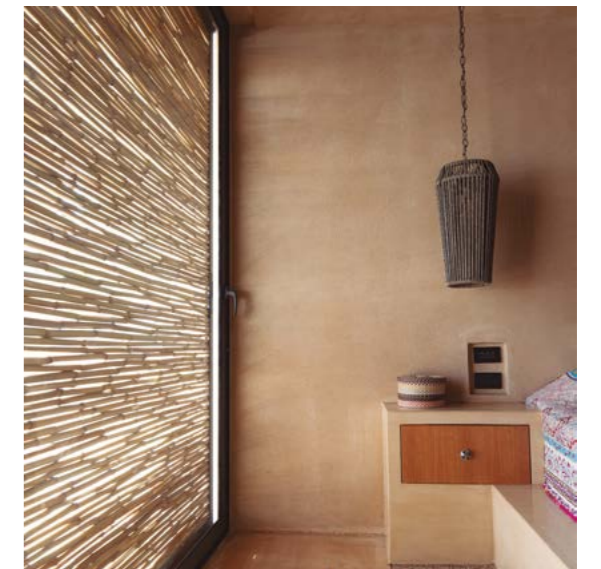

Architect & designer: this is your window

Architectural works are a combination of materials and space. The **Thermia C40 VERSIA** window series allows you to enclose, separate, and open these spaces. For architecture, it is a **fantastic tool for control and functional design**.

With slender and minimal lines, it is ideal for spaces seeking visual cleanliness.



With this series, we can design infinite glazed fronts, allowing us to enjoy **healthy natural light** while we observe the outside world from our favorite corner.

Versatility above all

Thermia VERSIA can be used in different solutions, all of which can be combined together.



Open and generous spaces like gardens and terraces are ideal for this sliding window series, especially the **90° joint solution**, a wonderful option for connecting indoors and outdoors.

90° JOINT

MULTI-TRACK FRAME

RECESSED FRAME

RECESSED frame + 90° joint solution

"GALANDAGE"

The "galandage" option can conceal up to 3 panes inside the wall, ideal for understated and elegant designs.

Thermia VERSIA is a powerful functional tool that will protect the indoors with optimal **thermal and acoustic insulation** properties, and ignite the imagination of any professional eager to sculpt and organize space.

Insulating

technology

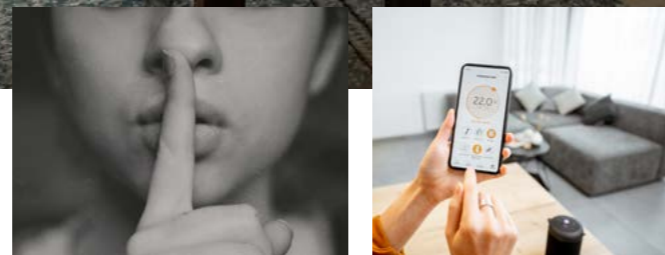
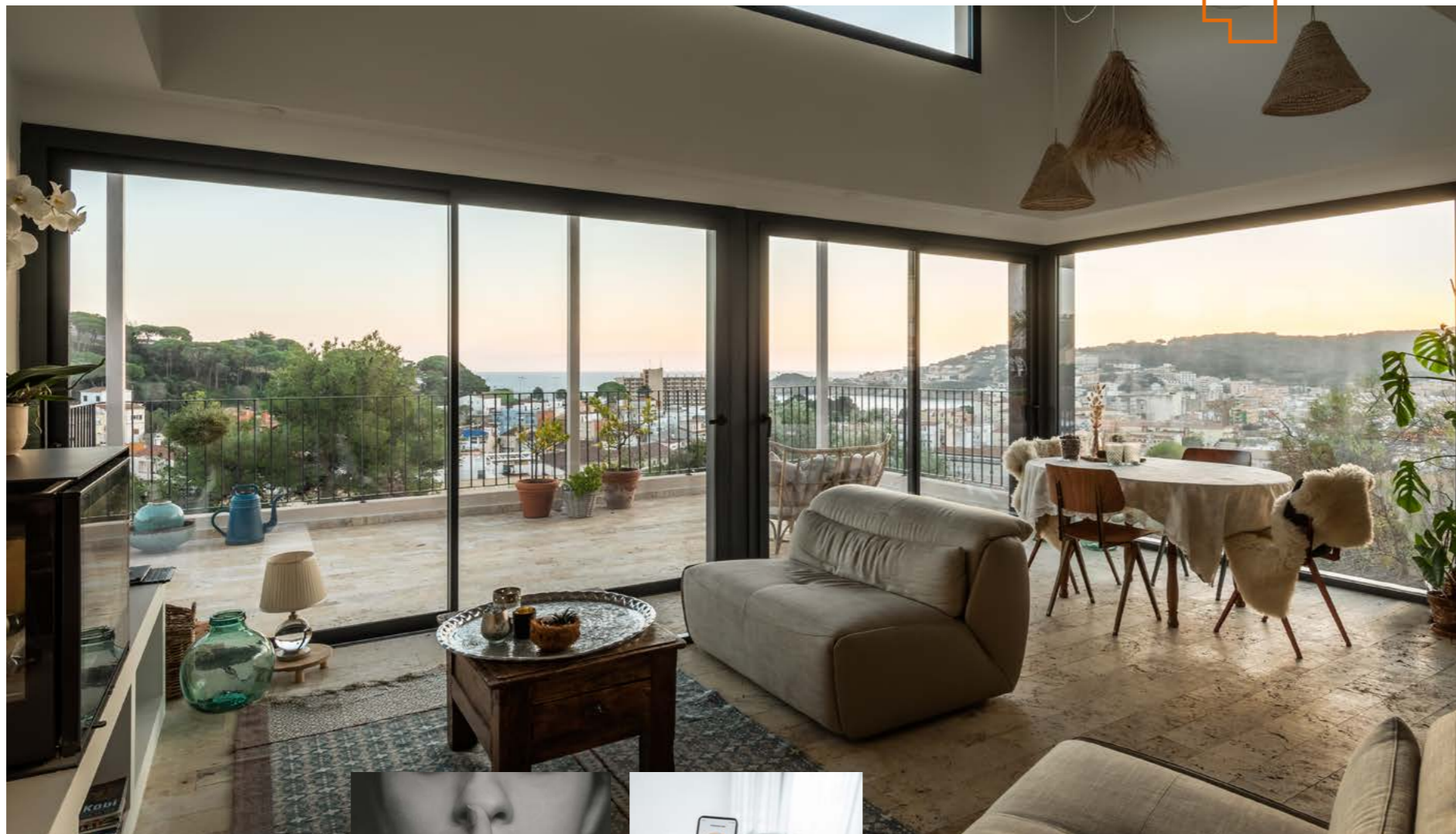

The airtight fit of Thermia VERSIA makes it an ideal solution for designs requiring insulation and comfort.

**Design
Comfort
Silence**

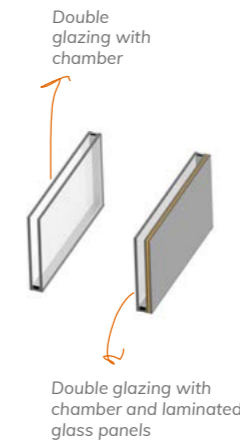

GLAZING

Its great glazing capacity facilitates the installation of high-insulating glass compositions.

28 mm
Maximum glazing capacity

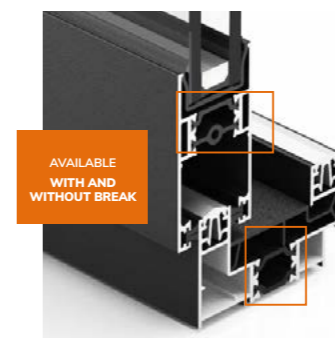

THERMAL BREAK (TB).

Thermia Versia is an aluminum system with a thermal break.

24 mm leaf **24 mm frame**
TB capacity TB capacity



FELT WEATHERSTRIP WITH WATER-REPELLENT SHEET

- "Fin-Seal" felt with central sheet of flexible and transparent PVC.
- Water-repellent bristles and increased wear resistance



ROLLER

- Metal body (interior/exterior)
- Tandem needle rollers with internal stainless steel bolts
- Up to 200 kg/leaf
- +/- 2.5 mm adjustment
- Tested under standard EN131126

Smooth handling



Every moment has its own movement



Design
Comfort
Silence

Movement fittings

MULTIPOINT CLOSURE



Handle
Ref. A0023700
KARMA line



Left hand opening offset handle
Ref. A0023738
KARMA line



Embedded handle
Ref. CR463751



Handle
Ref. A0003234
ITALIA line

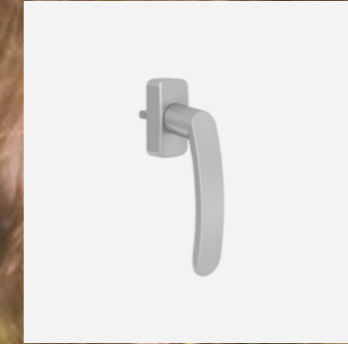

Handle
Ref. A0003237
SIRIUS Line

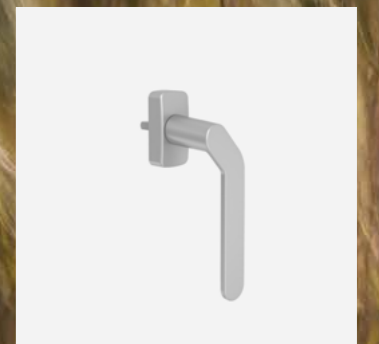

Left hand opening offset handle
Ref. A0003238
SIRIUS Line

For greater integration, handles can be lacquered in the same color as the frames.



Anatomy of Thermia VERSIA sliding window system

The Thermia CR40 VERSIA sliding window system is a system with all the benefits and guarantees of an airtight solution.



EUROPEAN QUALITY.
All the components are
sourced in Europe.



All the surface treatments have the
Qualicoat, Qualanod, and Qualideco
quality seals for imitation wood

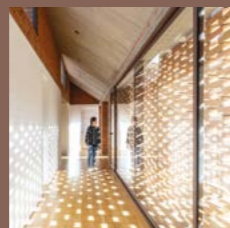

Excellent
performance against
atmospheric agents

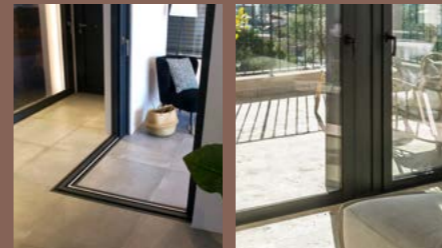

Many possible combinations.



Solution for large
glazed fronts





Thermia CR40 VERSIA

Sliding window system **WITH TB**



SERIES FEATURES	
Thermal break (TB)	Yes / 12 mm - 24 mm
Main frame	65 mm
Main leaf	40 mm
General thickness of the profiles	1.4 mm / 1.6 mm
Maximum glazing	28 mm
Maximum leaf weight	160 /200 kg /leaf
Track option	2, 3 or more tracks
90° frameless "KISS" closure solution	Yes
Available profiles	Window / Balcony Door



VERSION WITH TB

	THERMAL	Window $U_w = 1.58 \text{ W/m}^2\text{k}^*$ * In accordance with EN10077-02 3.2 x 2.4 m balcony door Glass $U_g = 1.1 \psi = 0.053$ Uf profile = 3.30 W/mk^2
	ACOUSTICS	Estimated acoustic insulation up to Rw 40 dB. with 44A/cam/44A acoustic laminated glass

TEST RESULTS

	Air permeability 4
	Watertightness Window 6A Balcony door 7A
	Wind resistance Window C5 Balcony door C2

Results of official tests performed on ENSATEC® 244728 and 243212 and on the basis of Annex E of standard EN-14351-1:2006 + A2:2016.

CROSS-SECTION

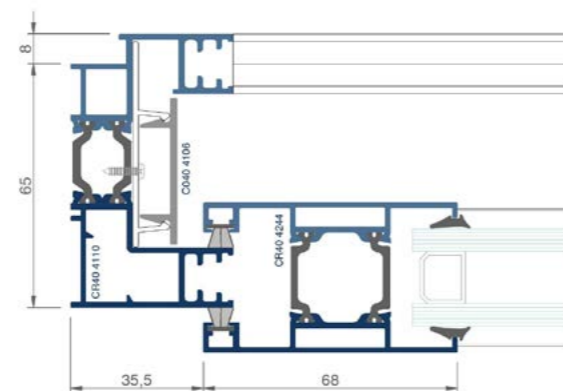

Quality seals



Qualanod seal for anodization
License number: 1014



Qualicoat seal for lacquer
License number: 405



Qualideco seal for imitation wood
License number: ES-0009F

Certification



THERMIA BARCELONA®
EN14351-1:2006+A2:2016

Thermia CF40 VERSIA

Sliding window system **WITHOUT TB**



SERIES FEATURES	
Thermal break (TB)	NO
Main frame	65 mm
Main leaf	40 mm
General thickness of the profiles	1.4 mm / 1.6 mm
Maximum glazing	28 mm
Maximum leaf weight	160 /200 kg /leaf
Track option	2, 3 or more tracks
90° frameless "KISS" closure solution	Yes
Available profiles	Window / Balcony Door



VERSION WITHOUT TB

	ACOUSTICS	Estimated acoustic insulation up to Rw 39 dB. Window size: 1.23 m x 1.45 m with acoustic laminated glass of 4.4/cam/4.4A
---	------------------	--

TEST RESULTS

	Air permeability 4
	Watertightness Window 6A Balcony door 7A
	Wind resistance Window C5 Balcony door C2

Results of official tests performed on ENSATEC® 244728-243212 and on the basis of Annex E of standard EN-14351-1:2006 + A2:2016

CROSS-SECTION

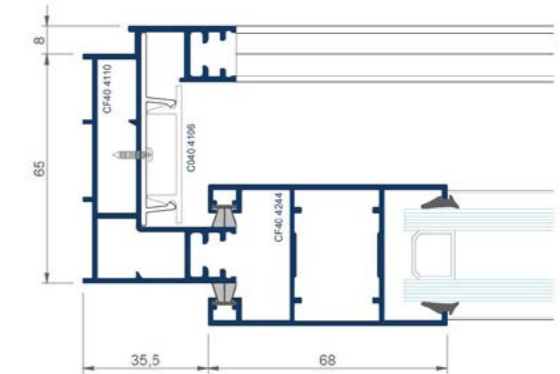

Quality seals



Qualanod seal for anodization
License number: 1014



Qualicoat seal for lacquer
License number: 405



Qualideco seal for imitation wood
License number: ES-0009F

Certification



THERMIA BARCELONA®
EN14351-1:2006+A2:2016

Structural solutions

21

Thermia C40 VERSIA

GALANDAGE SOLUTION

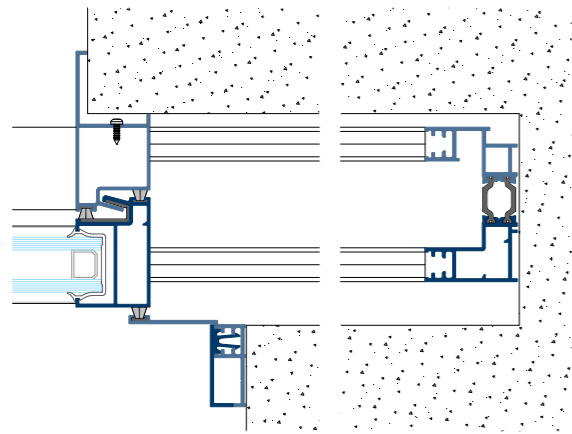

90° JOINT (KISS) SOLUTION

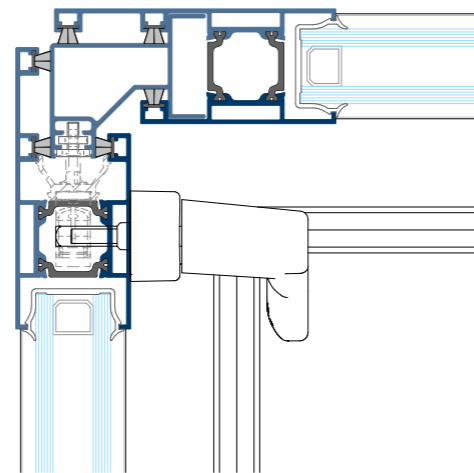
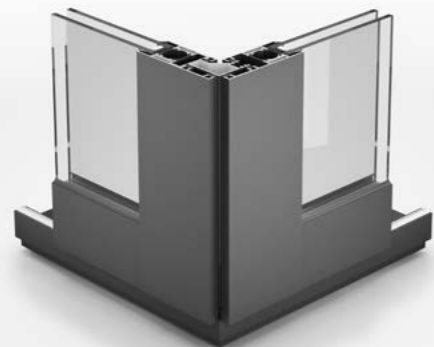

The ideal solution for completely unobstructed views

LATERAL MULTI-TRACK FRAME CROSS-SECTION

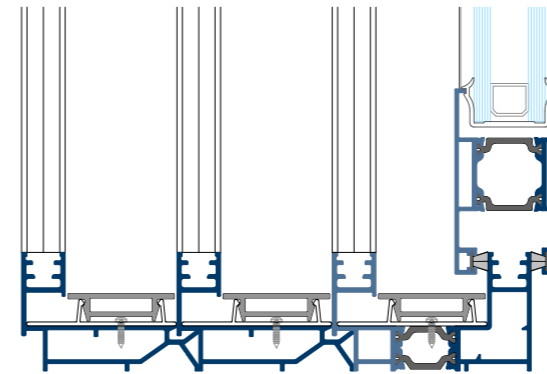

With just one additional profile, you can add as many tracks as the windows in your project require. This option allows you to play with the number and position of multiple panes.

RECESSED FRAME SOLUTION

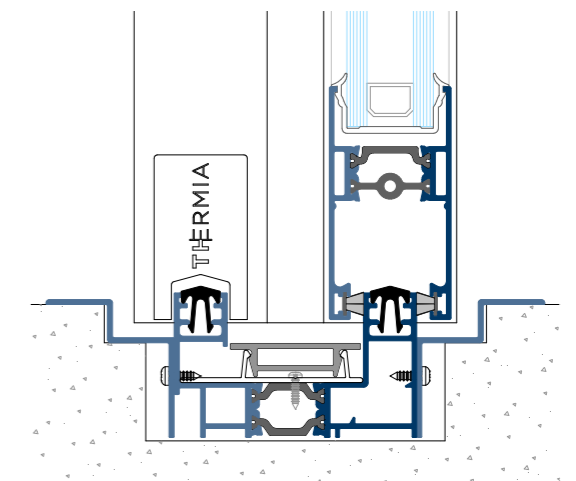
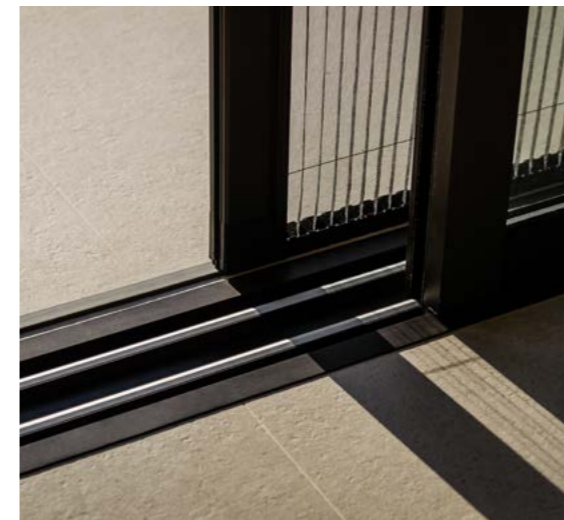

Zero architectural barriers

The Thermia VERSIA bottom rail can also be recessed into the floor to remove any architectural barriers between the indoors and outdoors.

NOTE: The cross-section drawings are NOT to scale
ALL SOLUTIONS PRESENTED IN THIS CATALOG ARE ALSO AVAILABLE IN THE VERSION WITHOUT TB.

SINGLE-TRACK SOLUTION

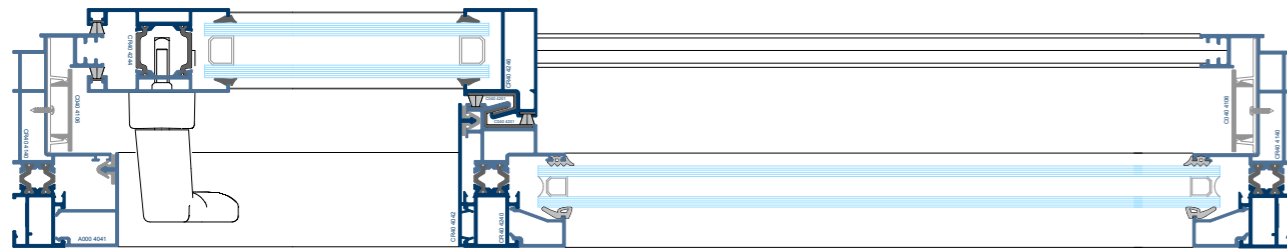

The ideal combination for hotels:
fixed single-track window

Another technical solution for structures where fixed parts are more important than mobile ones, but which require a free-moving area. The single-track system combines both in a faster, tighter, safer and more economical way.

SPECIFICALLY FOR HOTELS



CENTRAL LEAF CLOSURE CROSS-SECTION

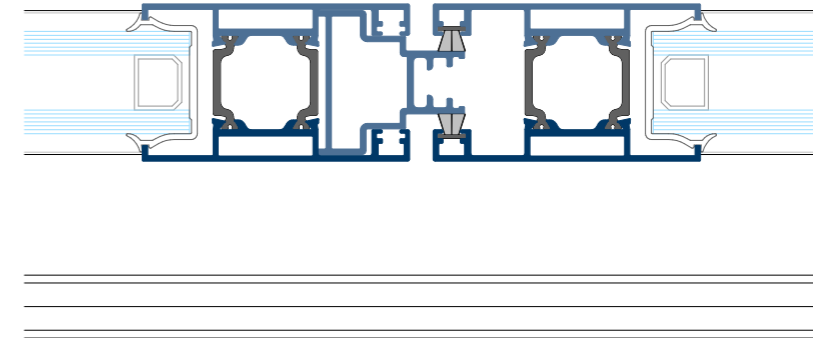

CENTRAL LEAF CLOSURE WITH REINFORCEMENT CROSS-SECTION

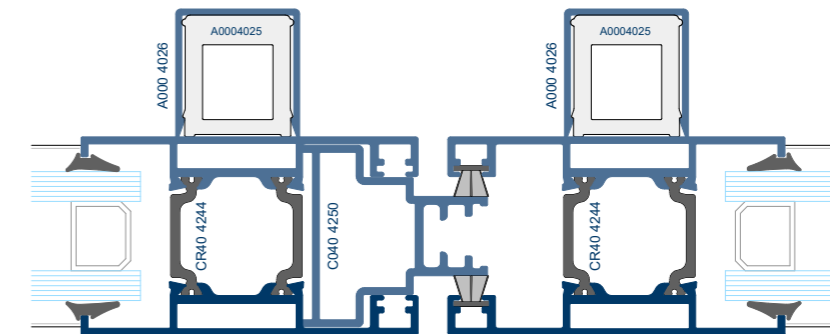

STANDARD REINFORCED CENTRAL CROSSOVER SOLUTION

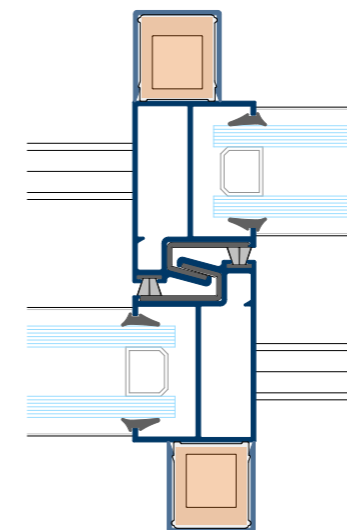

REINFORCED CENTRAL CROSSOVER SOLUTION

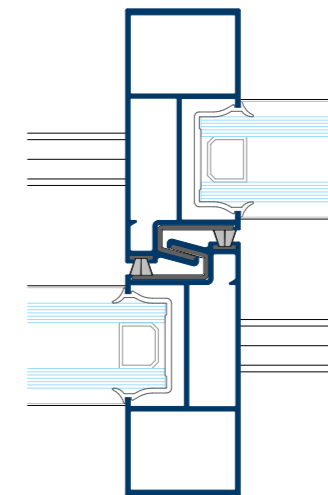

Taller windows

Possibility of manufacturing taller windows by replacing the panes of the standard central crossover with smaller reinforced panes. We increase the inertia, but maintain the visible section.



Everything begins with light, and our windows are the vehicle for you to enjoy it anytime.

Windows for a better life

THERMIA[®]
BARCELONA



THERMIA®

B A R C E L O N A

Headquarters in Barcelona

C/ Narcís Monturiol, 34
08192 Sant Quirze del Vallès
Barcelona (Spain)
Tel. +34 937 121 237
contacto@thermiabarcelona.com

Andean Area Offices

Los Telares, 289
Urbanización Industrial Vulcano
Ate, Lima (Peru)
Tel. +5117197649

Showrooms

Barcelona

Narcís Monturiol, 34
08192 Sant Quirze Vallès
(Spain)
Tel. +34 937 121 237

Arequipa

Av. Independencia, 1244
04001 Arequipa (Peru)
Tel. +51 95960448

Lima

Paseo de la República, 3583
2o. Piso - San Isidro, Lima
(Peru)
Tel. +5117197649

Cusco

Av. Pachacutec
501 Wanchaq, Cusco (Peru)
Tel. +5117197649

Girona

Carrer Sant Jordi, 2
Local 4 - Sarrià de Ter
(Spain)
Tel. +34 937 121 237

THERMIABARCELONA.COM

