



Catálogo de paneles de aluminio para puertas



Paneles Thermia



PT000



PT001



PT002



PT003



PT004



PT005



PT006



PT007

Composición paneles estándar:

Medidas: 2000mm x 800mm

Grosor: chapa 1,5mm + tablero marino 15mm + chapa 1,5mm

Vidrio: laminado 6 + 6 mate

Los precios aquí publicados son de paneles con composición estándar (vidrios incluidos en los modelos no opacos)

Otras composiciones consultar incrementos.

Ventanas para vivir mejor



PT008



PT009



PT010



PT011



PT012



PT013



PT014



PT015

Paneles Thermia

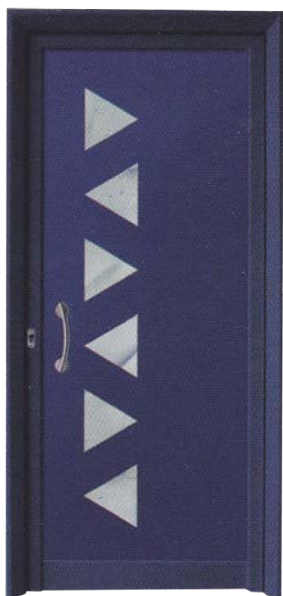

PT016



PT017



PT018

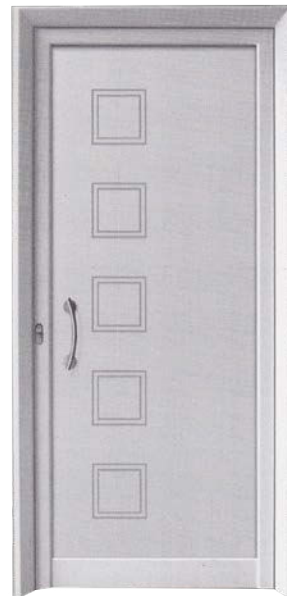

PT019



PT020



PT021

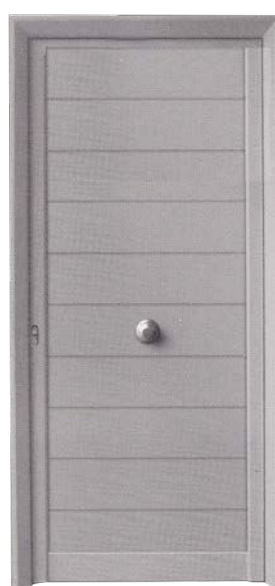

PT022



PT023

Composición paneles estándar:

Medidas: 2000mm x 800mm

Grosor: chapa 1,5mm + tablero marino 15mm + chapa 1,5mm

Vidrio: laminado 6 + 6 mate

Los precios aquí publicados son de paneles con composición estándar (vidrios incluidos en los modelos no opacos)

Otras composiciones consultar incrementos.

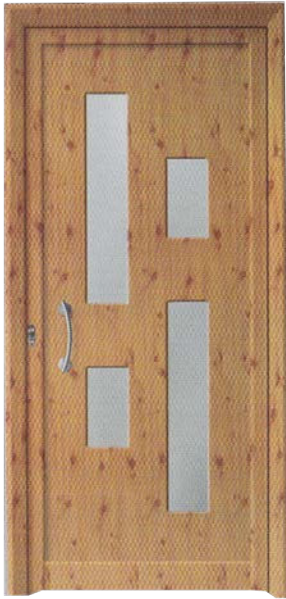

PT024



PT025



PT026



PT027



PT028



PT029



PT031



PT032



PT033

Adornos en acero inoxidable

Adornos en acero inoxidable

Adornos en acero inoxidable

Accesorios



A0003586

Tirador redondo individual 90° SS
mate 300 / 500 mm



A0003587

Tirador redondo individual 90°
SS mate 1300 / 1800 mm



A0003589

Tirador redondo individual 45° SS
mate 300 / 500 mm



A0003590

Tirador redondo individual 45° SS
mate 1300 / 1800 mm



A0003591

Tirador redondo individual 45° SP
acero inox mate punteado (dibujo)
300 / 500 mm

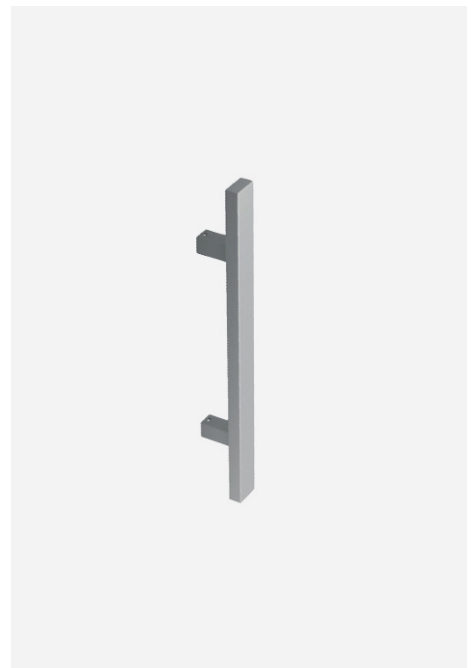

A0003593

Tirador cuadrado individual 40x20
mm 90° 300 / 500 mm

Ventanas para vivir mejor



A0003595

Tirador cuadrado individual 40x20 mm 90° 1300 / 1800 mm

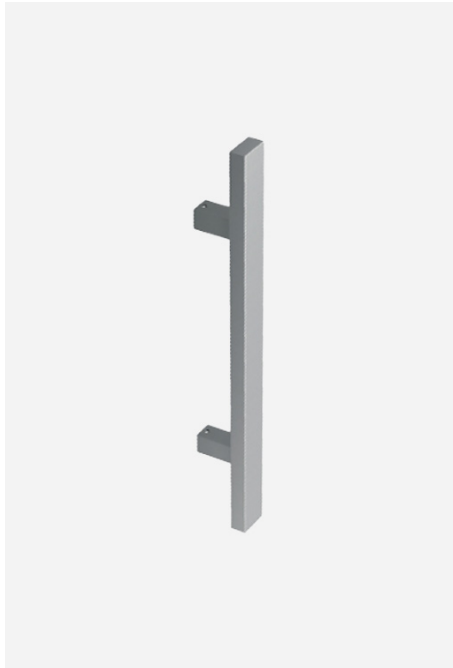

A0003597

Tirador cuadrado individual 40x20 mm 45° 300 / 500 mm

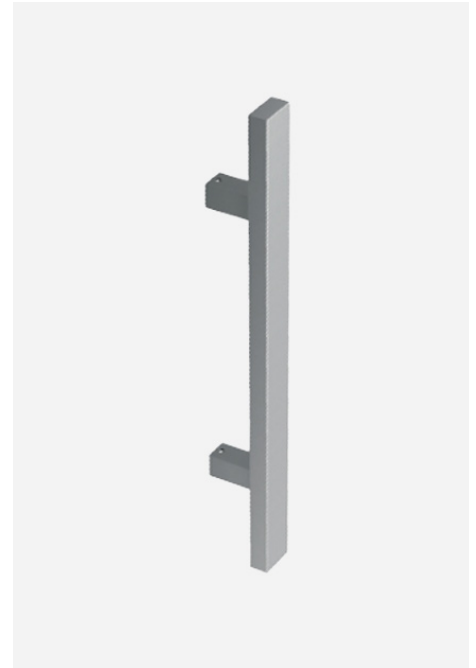

A0003599

Tirador cuadrado individual 40x20 mm 45° 1300 / 1800 mm



A0003580

Kit anclaje individual en hoja Thermia AF52 y AR52



A0003581

Kit anclaje individual en hoja Thermia AR62 y AR78+



A0003582

Kit anclaje individual en panel (universal)

Accesorios



A0003583

Kit tirador doble redondo 90°
acero inox mate 300 / 500 mm
(Accesorios anclaje incluidos)



A0003584

Kit tirador doble redondo 45° SS
acero inox mate 300 / 500 mm
(Accesorios anclaje incluidos)



A0003585

Kit tirador doble redondo 45° SP acero
inox punteado (dibujo) 300 / 500 mm
(Accesorios anclaje incluidos)



CPTPOMO1085
Pomo acero inoxidable 1085



CPTPOMO1095
Pomo acero inoxidable 1085



CPTMIRILLA
Mirilla



CPTTIRADOR450
Tirador acero inoxidable 450



CPTIRADOR471
Tirador acero inoxidable 471

Ventanas para vivir mejor

THERMIA®

B A R C E L O N A

Sede Central en Barcelona

C/ Narcís Monturiol, 34
08192 Sant Quirze del Vallès
Barcelona (España)
Tel. +34 937 121 237
contacto@thermiabarcelona.com

Delegación Área Andina

Los Telares, 289
Urbanización Industrial Vulcano
Ate, Lima (Perú)
Tel. +51-1-7197649

Showrooms

Barcelona

Narcís Monturiol, 34
08192 Sant Quirze Vallès
Barcelona (España)
Tel. +34 937 121 237

Girona

Carrer Sant Jordi, 2
Local 4 - Sarrià de Ter
Girona (España)
Tel. +34 937 121 237

Lima

Paseo de la República, 3583
2o. Piso - San Isidro
Lima (Perú)
Tel. +51-1-7197649

THERMIABARCELONA.COM

