

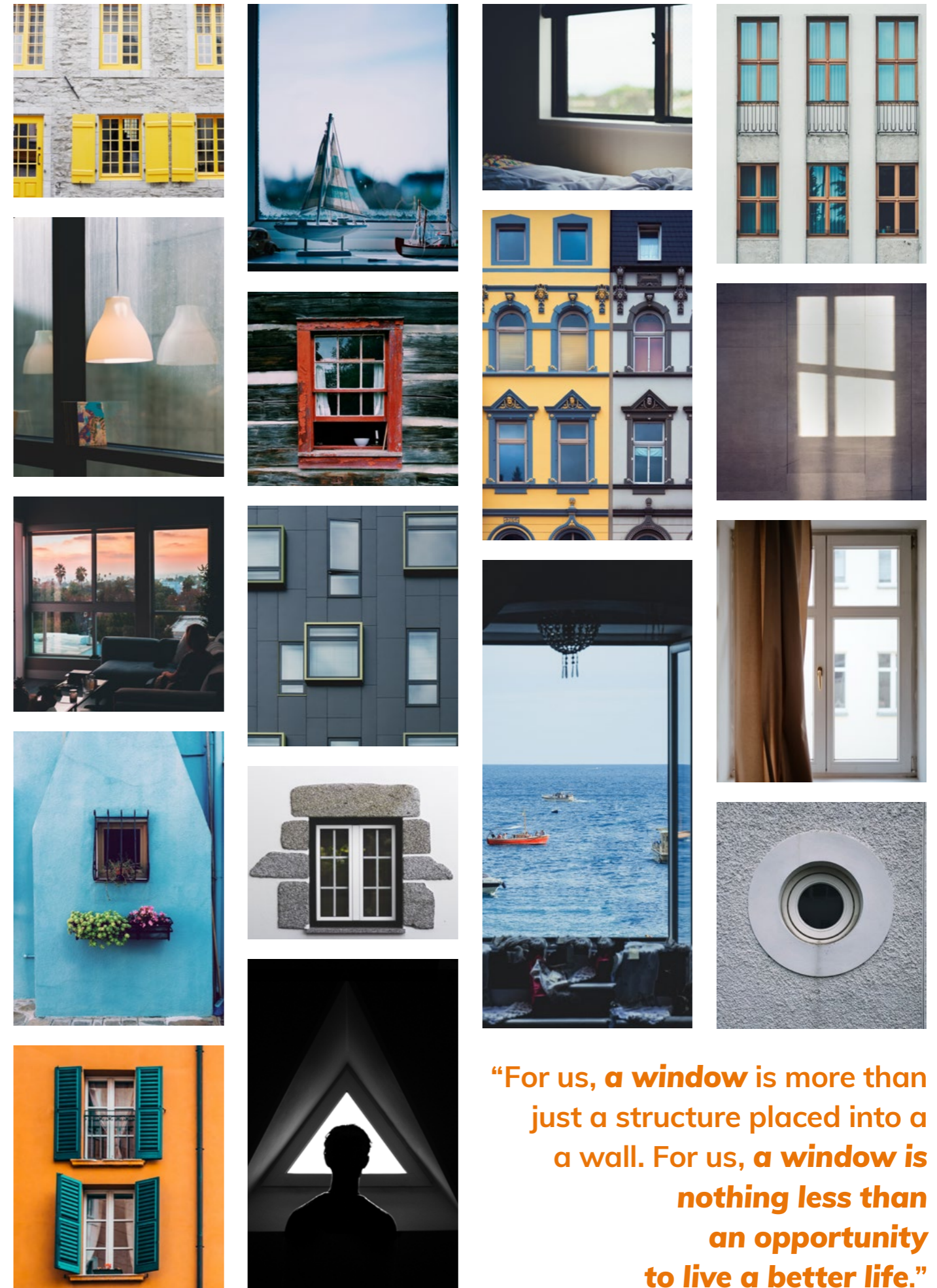

Windows for a **better life**

THERMIA®
BARCELONA

Windows for a **better life**



“For us, **a window** is more than just a structure placed into a wall. For us, **a window** is **nothing less than an opportunity to live a better life.**”





“Looking from outside into an open window you never see as much as when you look through a closed window. There is nothing more profound, more mysterious, more pregnant, more insidious, more dazzling than a window lighted by a single candle. What you can see out in the sunlight is always less interesting than what goes on behind a window pane. In that black or luminous square life lives, life dreams, life suffers.”

Charles Baudelaire.

Design
Comfort
Silence

TABLE OF CONTENTS

Thermia Barcelona

Approach and philosophy of Thermia Barcelona	8
Quality beyond the product	10
Facilities	12

Completed works

Clients who have put their trust in Thermia Barcelona	14
---	----

Thermia® windows

Types of windows	22
Technical solutions	24
Accessories	25
Colors and finishes	26

Our CE casement windows

Thermia® AF35 CE	30
Thermia® AF52 CE	32
Thermia® AR52 CE	34
Thermia® AR62 CE	36
Thermia® AR78+ CE	38

Our Canal16 casement windows

Thermia® AF52 C16	40
Thermia® AR78+ C16	42
Thermia® OC78+ C16	44

Our sliding windows

Thermia® CF22	46
Thermia® CF26	48
Thermia® CF31	50
Thermia® CR31	52
Thermia® CF40	54
Thermia® CR40	56
Thermia® CR46	58
Thermia® ER52	60

Other products

Thermia PM	62
Thermia® MQ22	66
Thermia® AF52M	68
Thermia® GR48	70
Thermia® Celosía	72
Thermia Railing	73

Manufacture of Thermia® windows

Manufacture Thermia® windows	74
Install Thermia® windows	75

Windows for a better life

Energy efficiency	76
The noise problem	78

Appendix

Summary of profiles	82
Technical chart of Thermia® systems	86
Acoustic properties of glass windows	88
International distribution	89

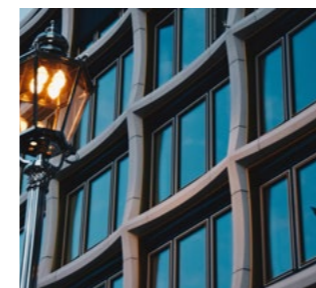



Work: Genial Houses (Girona) | Architect: Ricard Turón | ©Images: Marc Torra Fragments.cat

Thermia
Barcelona is
the perfect
partner for
your projects.

“Our products are the result
of **exhaustive study and
design**, with the aim of
offering the client **much
more than a window.**”

Open up a world of
possibilities for your
business by offering
our **windows for a
better life.**

Design
Comfort
Silence



Our way of understanding what we do: **Thermia Barcelona's philosophy and approach.**

The human capabilities of Thermia Barcelona are what define us as a company. Without our team of involved and committed professionals, it would be very difficult to do what we do.

And this aspect, that of close involvement, is what we try to convey in our dealings with every client. Our commitment extends beyond the purchase of the product. We are committed to advising you, listening to you, and supporting you through every step of your project.

Windows for a better life

Thermia Barcelona®



One of our goals at Thermia Barcelona is to ensure that **you as a client can work with our product with full confidence in the quality, design and comfort** that the market demands; you need to feel that you partnered with a **responsible, professional team that will guide you and support you at all times.**

What does a window represent for Thermia Barcelona?

"We think of a window as something more than a structure placed into a wall.

For us, a window must go further; it must create spaces where there were none before; it must allow our home to be bathed in natural light; it must be airtight to protect us from cold and heat; it must provide us with

a silent environment; have a design that harmonizes with the rest of the architecture, and it must facilitate energy savings. A window should help create a more comfortable and functional home, with minimal effort on the part of the user.

For Thermia®, a window is nothing less than an oppor-

tunity for a better life. And that is why we need to produce a high-quality product.

A window of this excellence can only be created through an ingenious design system. In other words, all the elements that make up the window must have been studied and must be properly combined so that the

window fulfills the mission we have entrusted to it.

The technical area of Thermia Barcelona is constantly looking for ways to improve and fine-tune the system, in order to improve the features of each and every one of our windows."

Committed, professional, leading-edge, technically-minded, involved, transparent, curious, empathic, optimistic, sensitive. That is the approach that we take here at Thermia Barcelona.



Design
Comfort
Silence

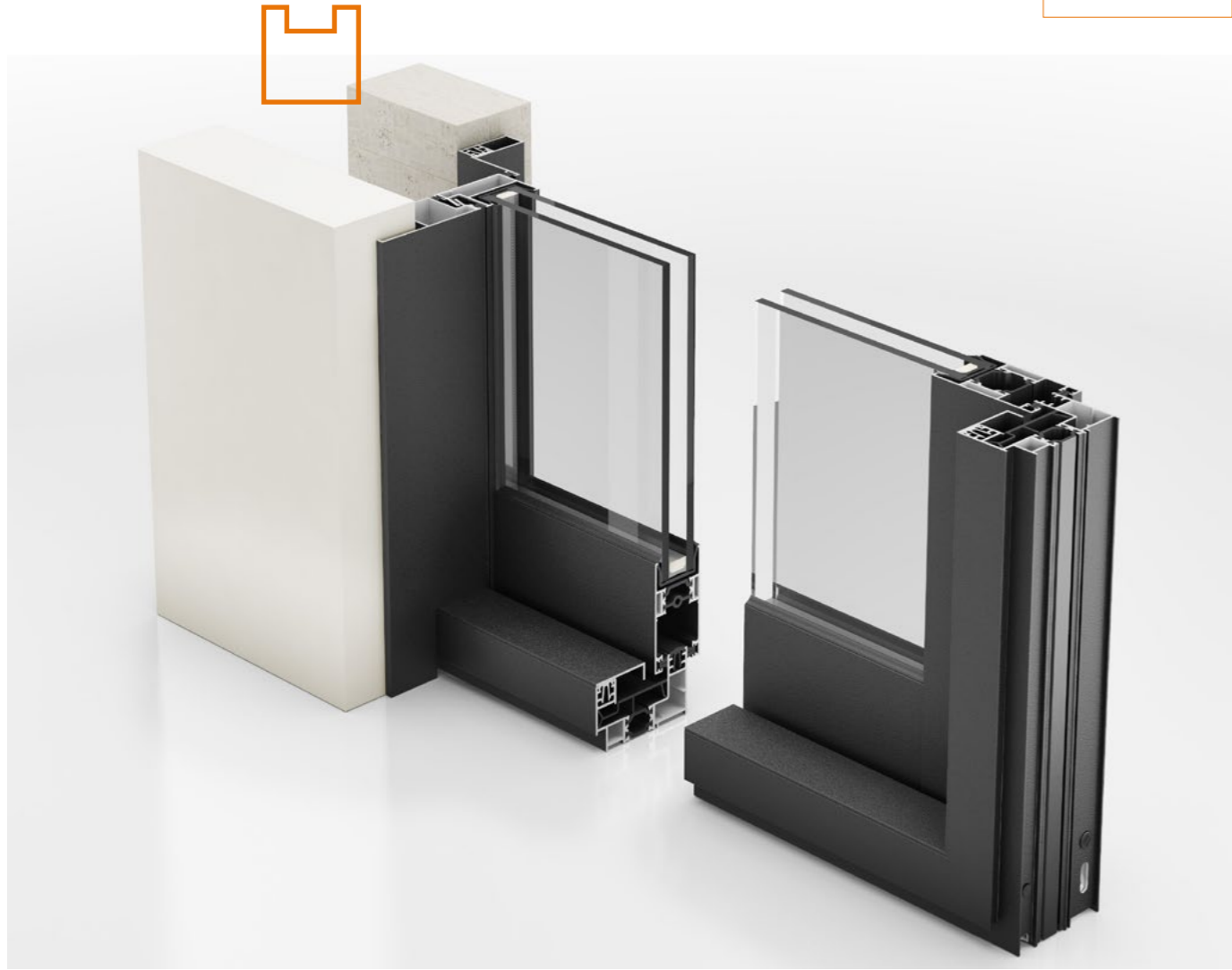

The quality of Thermia® windows: a constant from start to finish.

In an increasingly demanding market, we must offer our clients an option with maximum assurance of certified quality.

All Thermia Barcelona® enclosure systems are designed and tested

in strict compliance with European market regulations, which require high performance in terms of airtightness, durability and performance in inclement weather, together with maximum energy savings.

Windows for a better life

Thermia Barcelona®



All Thermia® windows are manufactured by specially-trained professionals to ensure that every component of the window will work properly.

Thermia Barcelona Systems are extruded and assembled in accordance with ISO 9001 and tested under Standard EN 14351-1:2006.

The surface treatments have the QUALICOAT quality seal for lacquer, QUALIDECO for imitation wood lacquer, and QUALANOD for anodization.

In-house Technical Department



All Thermia® European window systems are developed in-house.

1. Better control and speed in implementing system improvements.

2. System adaptations for specific markets or even individual works.

3. Constant innovation to adapt our product to market changes.

QUALITY SEALS



All Thermia Barcelona® Systems are tested in laboratories approved to conduct air permeability, water tightness and wind resistance tests.

Design
Comfort
Silence

Thermia Barcelona®



Windows for a better life



More than 7000m²
of space
to serve our clients.

**Look. Touch.
Handle.**
Without a doubt,
the best way to
get to know our
product.

Facilities. Where Thermia® windows are designed.

Thermia Barcelona's headquarters are located in Sant Quirze del Vallès (Barcelona). This strategic location, in proximity to major international sea ports and airports, allows us to deliver products to our customers at any destination in the world, quickly and efficiently.

Most visits to our
showroom in Barcelona
end in a **sale.**

Thermia Barcelona's showroom. A powerful selling tool for our clients.

In this interactive space, you can observe the technical features of the system directly, handle every product category, and experience our product quality for yourself. Everything you need to help you or your clients make a decision.





Thermia® windows
around the world.
Top projects.

Windows for a better life

Works



Hotel Aromar

Architect: XS arquitectes

Location: Costa Brava – Catalonia, Spain.

© Images Eugeni Pons. All rights reserved.

Design
Comfort
Silence

Windows for a better life

Works



Casa RDP

Location: Quito, Ecuador.
Winner of the Quito Architecture Biennial BAQ2016
Finalist in the Latin American Architecture Biennial 2017
Architects: Daniel Moreno Flores / Sebastián Calero



Casa RDP



Casa RDP



Design
Comfort
Silence



WYNDHAM Hotel

Hotels.
Quieter, better insulated guest rooms, leading to a higher rate of satisfaction.



WYNDHAM Hotel



Windows for a better life

Works



Wyndham Hotel Quito International Airport

Location: Mariscal Sucre Airport - Quito, Ecuador.
Architect: Grupo Pronobis.





Klimt Building

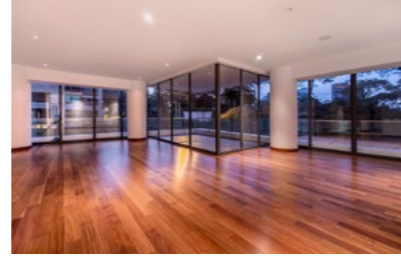

Klimt Building

Thermia® windows in Spain, France, Algeria, Peru, Colombia, Ecuador, Chile, Uruguay, El Salvador, Panamá, Dominican Republic, India.



Klimt Building



Klimt Building

Location: Miraflores District - Lima, Peru
Architect: Bernardo Fort Brescia.



Design
Comfort
Silence



Windows for a better life

Thermia® windows

A Thermia® window for everyone

Thermia® Systems have been developed to provide a solution for every type of architectural structure. Everything is conceived to allow our clients to choose:

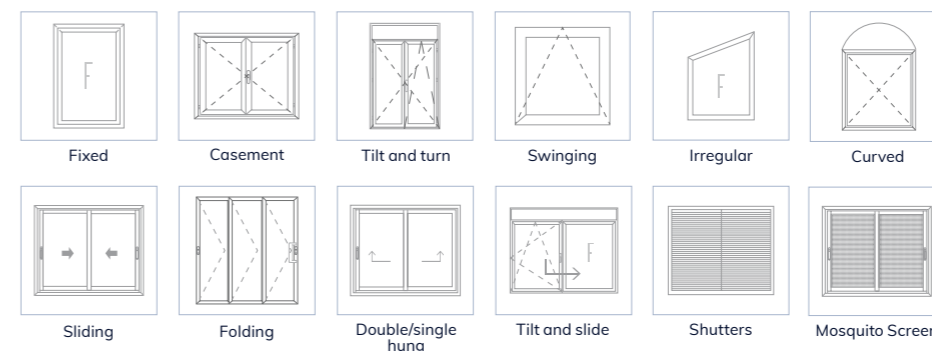

Types of windows offered by Thermia Barcelona®

Design
Comfort
Silence

Technical solutions. Windows for all types of projects.



Windows for a better life

Thermia® windows

Accessories. Getting the details right.



Esthetic solutions

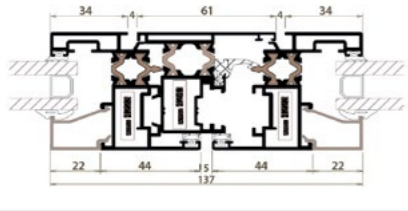

Straight lines.

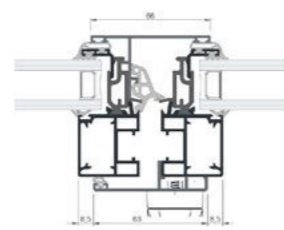

Hidden leaf.

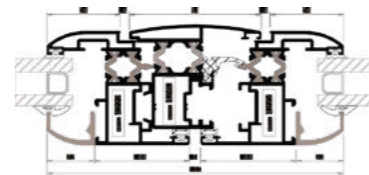

Curved lines.

Technical solutions

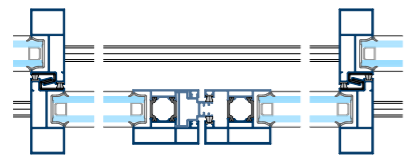

Reinforced leaf.

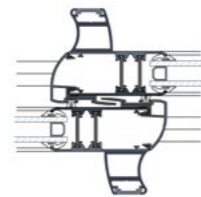

Handle reinforcement sliding window leaf.

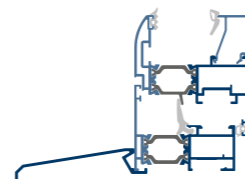

Lower tray.

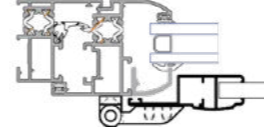

Internal shutter.

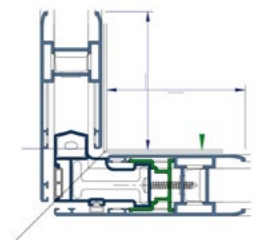

90° corner.

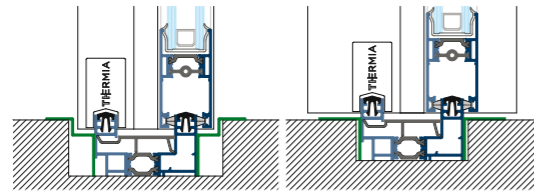

Recessed lower frame.

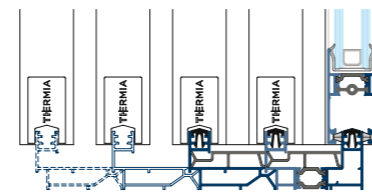

Multi-track frame.

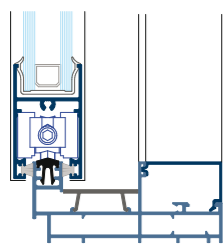

Single track and fixed. The ideal combination for hotels.

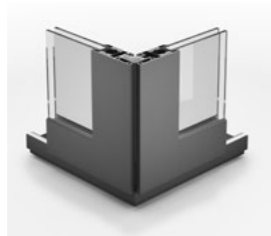

'Kiss 90°' (front view)

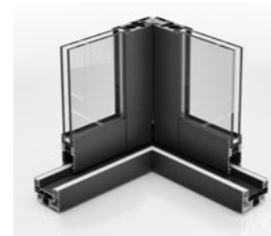

'Kiss 90°' (inside view)



'Pocket'



Bearings

Height-adjustable, nylon 6/6 + 30% fiberglass, turned and with single or double ball or needle wheels, depending on the weight borne (40, 80, 160, 200 kg.) F212 stainless steel cap and wheels, and anti-corrosive coating.

Folding handles

Manufactured under the ISO 9001 seal. Tested for 25,000 cycles with cast aluminum and AISI 430F stainless steel.

Sliding window multi-point closure

Manufactured under the ISO 9001 seal. Tested for 25,000 cycles.

CE tilt and turn

Manufactured under the ISO 9001 seal. Tested for 25,000 cycles up to 130 kg. Per leaf. Made of high-density zamac with an anti-corrosion treatment and AISI 430F stainless steel. Height and width adjustable +/- 1mm.

CE Projecting stay hinges

Manufactured under the ISO 9001 seal. Made of AISI 430 stainless steel. Tested for 25,000 cycles.

CE hinges

Manufactured under the ISO 9001 seal. Tested for 200,000 cycles. Capable of bearing loads of up to 70 kg. (2 hinges) and 90 kg. (3 hinges). Made of extruded aluminum and AISI 430F stainless steel.

CE door hinges

Manufactured under the ISO 9001 seal. Tested for 200,000 cycles. Capable of bearing loads of up to 90 kg. (2 hinges) and 110 kg. (3 hinges). Made of extruded aluminum and stainless steel.

Sealing and glazing gaskets

All made of top-quality EPDM rubber to maintain their properties over time and without deterioration caused by heat and cold, providing windows with a hermetic seal for years.

Weatherstripping

Manufactured with double or triple stitching. Provided with an integrated water-repellent textile film that acts as a barrier against the passage of air, water, and noise, allowing the panes to slide silently.

Corner joints

Made of cast aluminum and held with stainless steel screws, assuring protection against rust at the joints, where there the window is most exposed to water.

Surface treatments

Based on testing in neutral salt-spray chamber as per standard EN 1670: 2007 with classes 4 and 5.

Only the best accessory brands guarantee that windows will work properly and keep performing for a long time. This is why **Thermia Barcelona® windows are made exclusively with accessory brands manufactured in accordance with European standards.**

Every component of the window has undergone open-close cycle testing and corrosion measurement in a salt-spray chamber.



Design. Comfort. Silence.

Windows with a style of their own.

At Thermia Barcelona®, we understand the importance of design in the architectural world, and that's why we offer today's most sought-after colors and finishes at the best price. So that you can add that special touch to your projects.



Profile surfaces are treated to ensure long-lasting windows. Every treatment has a quality seal, meaning that every Thermia window manufactured or sold to your clients is synonymous with reliability and durability.

Windows for a better life

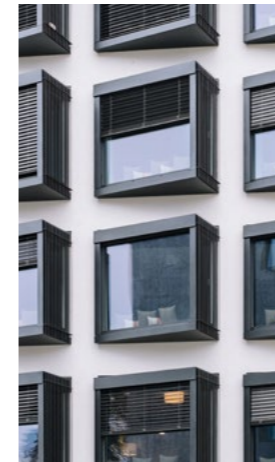

Quality seals

ANODIZERS ASSOCIATION
EUROPEAN ANODIZERS ASSOCIATION
AA
Qualanod
Qualanod seal for anodization
License number: 1014

QUALIDECO
Qualideco seal for imitation wood
License number: ES-0009F

QUALICOAT
Qualicoat seal for lacquer
License number: 405

Thermia® windows

Standard price	Glass	Matte	Texture
RAL 1013 color cream	✓	✗	✓
RAL 1015 color cream	✓	✓	✓
RAL 3005 color red	✓	✓	✗
RAL 5010 color blue	✓	✗	✓
RAL 5014 color blue	✗	✗	✓
RAL 6005 color green	✓	✓	✓
RAL 6009 color green	✓	✓	✓
RAL 6021 color green	✗	✗	✓
RAL GRAFIT color gray	✗	✓	✗
RAL 7012 color gray	✓	✓	✓
RAL 7015 color gray	✗	✗	✓
RAL 7016 color gray	✓	✓	✓
RAL 7022 color gray	✓	✓	✓
RAL 7024 color gray	✓	✗	✓
RAL 7031 color gray	✗	✗	✓
RAL 7035 color gray	✓	✓	✓
RAL 8014 color brown	✓	✓	✓
RAL 8017 color brown	✓	✓	✓
RAL 8019 color brown	✓	✓	✓
RAL 9010 color white	✓	✓	✓
RAL 9011 color black	✓	✓	✓
RAL 9016 color white	✗	✓	✓

Special price	Glass	Matte	Texture
Cobre óxido	✗	✗	✓
Noir 100 sable	✗	✗	✓
Noir 200 sable	✗	✗	✓
Brun 650 sable	✗	✗	✓
Blue 600 sable	✗	✗	✓
Gray 150 sable	✗	✗	✓

Wood price	Glass	Texture
Pino envejecido	✗	✓
Sapelli caoba	✓	✓
Roble golden	✗	✓
Pino nudo	✓	✓
Castaño oscuro	✓	✓
Embero dorado	✗	✓
Nogal oscuro	✗	✓
Roble irlandés	✗	✓
Fresno	✗	✓
Wenge	✓	✓
Nogal andaluz	✓	✓
Cerezo claro	✓	✓
Teka	✓	✓

Anodized price	Matte	Polished
Bronze	✓	✓
Stainless steel	✓	✓
Silver	✓	✓



Thermia Barcelona® series

Systems for aluminium windows

Windows for a better life

Our product series



THERMIA® AF35 CE SERIES



THERMIA® AF52 CE SERIES



THERMIA® AR52 CE SERIES



THERMIA® AR62 CE SERIES



THERMIA® AR78+ CE SERIES



THERMIA® AF52 C16 SERIES



THERMIA® AR78+ C16 SERIES



THERMIA® OC78+ C16 SERIES



THERMIA® CF22 SERIES



THERMIA® CF26 SERIES



THERMIA® CF31 SERIES



THERMIA® CR31 SERIES

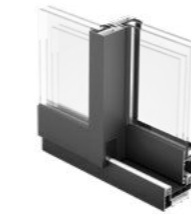

THERMIA® CF40 SERIES



THERMIA® CR40 SERIES



THERMIA® CR46 MAGNA SERIES



THERMIA® ER52 SERIES



THERMIA® AF52M SERIES



THERMIA® PM SERIES



THERMIA® GR48 SERIES



THERMIA® MQ22 SERIES

Thermia® AF35 CE

Basic Casement Series



Technical features Thermia® AF35 CE	
Thermal break	No
Main frame	35 mm
Main sash	35 mm
Profile thickness	1.2 mm
Maximum glass thickness	8 / 21 mm
Maximum glass weight	90 Kg
Tilt and turn leaf maximum weight	130 Kg
Available profiles	Window

Allows multiple pane-opening systems.

- Projecting
- Casement
- Tilt and turn
- Fixed structure



Acoustic attenuation up to 34 dB
(Window size: 1230cm x 1450cm with acoustic laminated glass.)

Thermia® AF35 CE test results

- Air permeability **4**
- Watertightness **9A**
- Wind resistance **C3**

Results of official tests performed on Applus and on the basis of Annex E of standard EN-14351-1:2006

Cross-section of Thermia® AF35 CE series

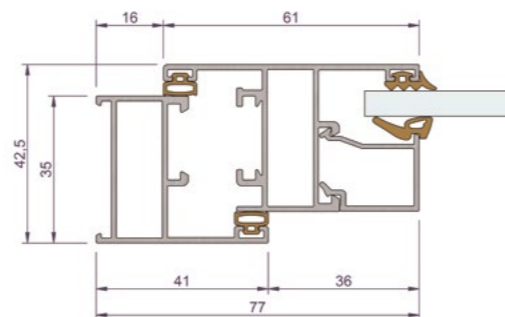

Quality seals

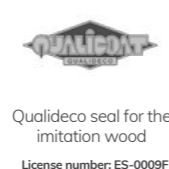

Certification

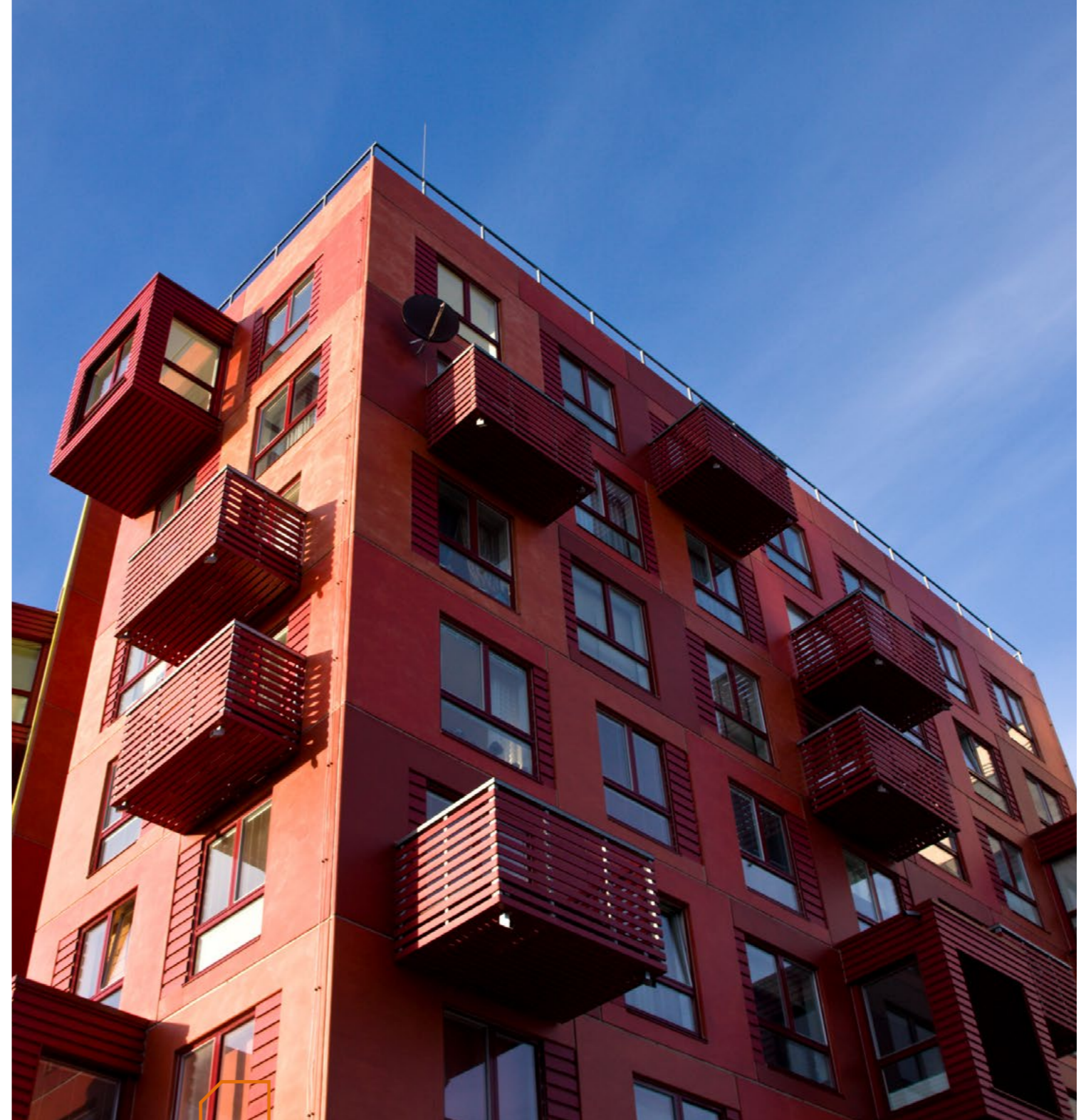

The basic, effective window

Windows for a better life

Thermia® AF52 CE

Standard Casement Series

Technical features Thermia® AF52 CE	
Thermal break	No
Main frame	45 mm
Main sash	52 mm
Profile thickness	1.5 / 1.8 mm
Maximum glass thickness	27 mm
Maximum glass weight	90 Kg
Tilt and turn leaf maximum weight	130 Kg
16 mm channel	Yes
Available profiles	Window / Door

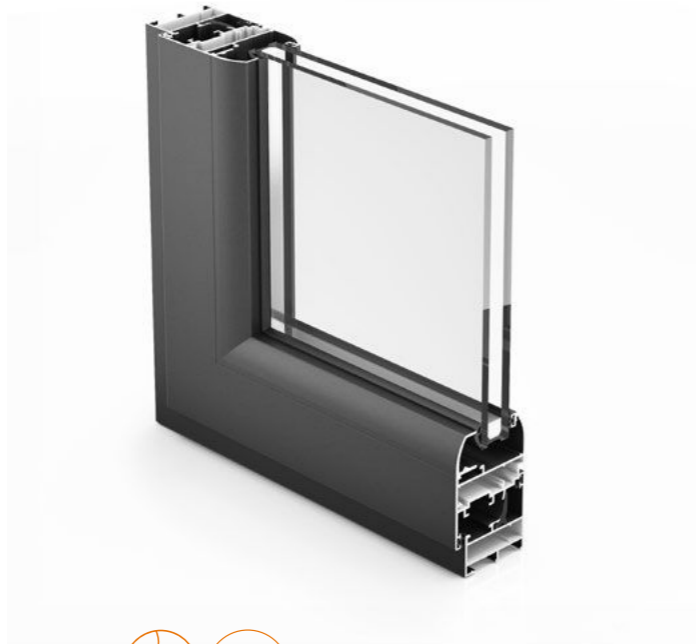

Acoustic attenuation up to 39 dB
(Window size: 1230cm x 1450cm with acoustic laminated glass.)



Thermia® AF52 CE test results

-  Air permeability **4**
-  Watertightness **9A**
-  Wind resistance **C5**

Results of internal tests performed on the basis of Annex E of standard EN-14351-1:2006

Cross-section of Thermia® AF52 CE series

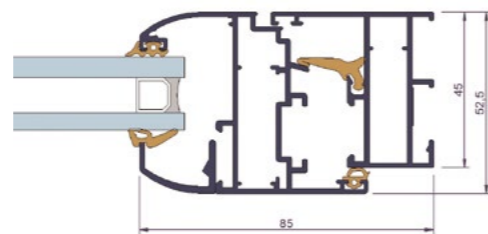

Quality seals



Qualanod seal for the anodization
License number: 1014



Qualicoat seal for the lacquer
License number: 405



Qualideco seal for the imitation wood
License number: ES-0009F

Certification



THERMIA BARCELONA
EN14351-1:2006+A2:2016

The silence that you have been looking for

Windows for a better life

Our product series

Thermia® AR52 CE

Standard RPT Casement Series

Technical features Thermia® AR52 CE	
Thermal break	Yes / 14 mm
Main frame	45 mm
Main sash	52 mm
Profile thickness	1.5 / 1.8 mm
Maximum glass thickness	27 mm
Maximum glass weight	90 Kg
Tilt and turn leaf maximum weight	130 Kg
Available profiles	Window / Door

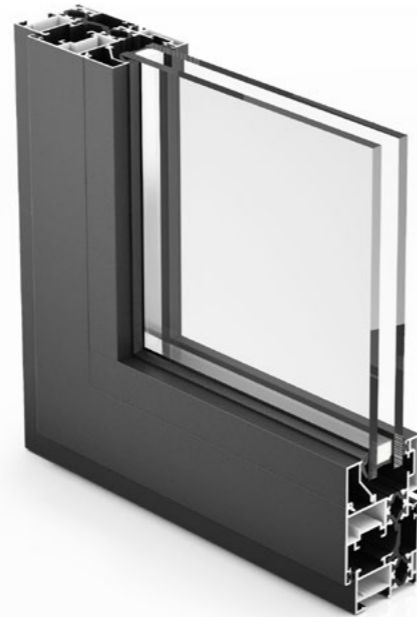

Uw window = 1.56 W/mk²*

* Based on EN 10077-02 Single-leaf 1.5x2.4 balcony door glass Ug= 1.1 ψ= 0.053

40 dB

Acoustic attenuation up to 40 dB
(Window size: 1230cm x 1450cm with acoustic laminated glass.)

CASEMENT / Thermia® AR52 CE

Thermia® AR52 CE test results

-  Air permeability **4**
-  Watertightness
Window: **9A** Balcony door: **6A**
-  Wind resistance
Window: **C4** Balcony door: **C2**

Results of official tests performed on Ensatec 212454 and 212466 and on the basis of Annex E of standard EN-14351-1:2006

Cross-section of Thermia® AR52 CE series

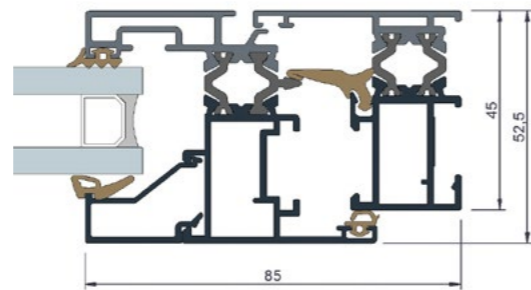

Thermal insulation and acoustic isolation for everyone

Quality seals



Certification



Windows for a better life

Thermia® AR62 CE

Top RPT Casement Series

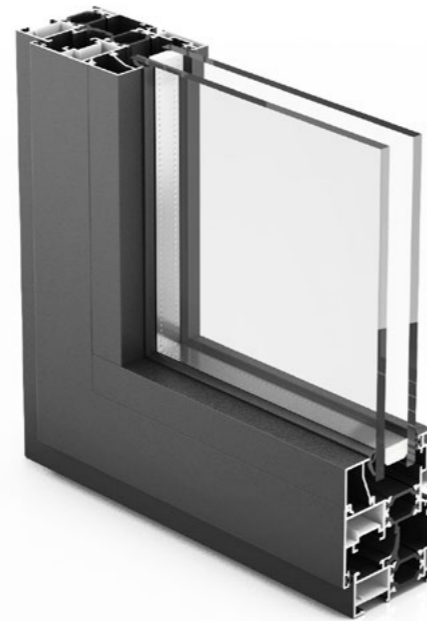

Technical features Thermia® AR62 CE	
Thermal break	Yes / 24 mm
Main frame	55 mm
Main sash	62 mm
Profile thickness	1.5 / 1.8 mm
Maximum glass thickness	37 mm
Maximum glass weight	90 Kg
Tilt and turn leaf maximum weight	130 Kg
Available profiles	Window / Door

Uw window = 1.46 W/mk²*

* Based on EN 10077-02 Single-leaf 1.5x2.4 balcony door glass Ug= 1.1 ψ= 0.053



42 dB

Acoustic attenuation up to 42 dB
(Window size: 1230cm x 1450cm with acoustic laminated glass.)

Thermia® AR62 CE test results



Air permeability
4



Watertightness
Window: E1050 Balcony door: 8A



Wind resistance
Window: C5 Balcony door: C2

Results of official tests performed on Ensatec 232623 and 232624 and on the basis of Annex E of standard EN-14351-1:2006

Cross-section of Thermia® AR62 CE series

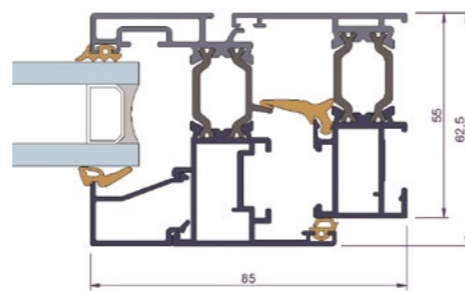

Guaranteed savings and well-being

Quality seals



Qualanod seal for the anodization
License number: 1014



Qualicoat seal for the lacquer
License number: 405



Qualideco seal for the imitation wood
License number: ES-0009F

Certification



THERMIA BARCELONA
EN14351-1:2006+A2:2016

Thermia® AR78 CE

Extreme RPT Casement Series

Technical features Thermia® AR78 CE	
Thermal break	Yes / 24 mm
Main frame	70 mm
Main sash	78 mm
Profile thickness	1.5 / 1.8 mm
Maximum glass thickness	49 mm
Maximum glass weight	90 Kg
Tilt and turn leaf maximum weight	130 Kg
16 mm channel	Yes
Available profiles	Window / Door





Uw window = 1.07 W/mk^{2*}

* Based on EN 10077-02 Single-leaf 1.7x2.6 balcony door glass Ug= 0.7 ψ= 0.046



Acoustic attenuation up to 45 dB
(Window size: 1230cm x 1450cm with acoustic laminated glass.)

Thermia® AR78 CE test results

-  Air permeability **4**
-  Watertightness **E1050**
-  Wind resistance
Window: **C5** Balcony door: **C4**

Results of official tests performed on Applus and on the basis of Annex E of standard EN-14351-1:2006

Cross-section of Thermia® series AR78 CE

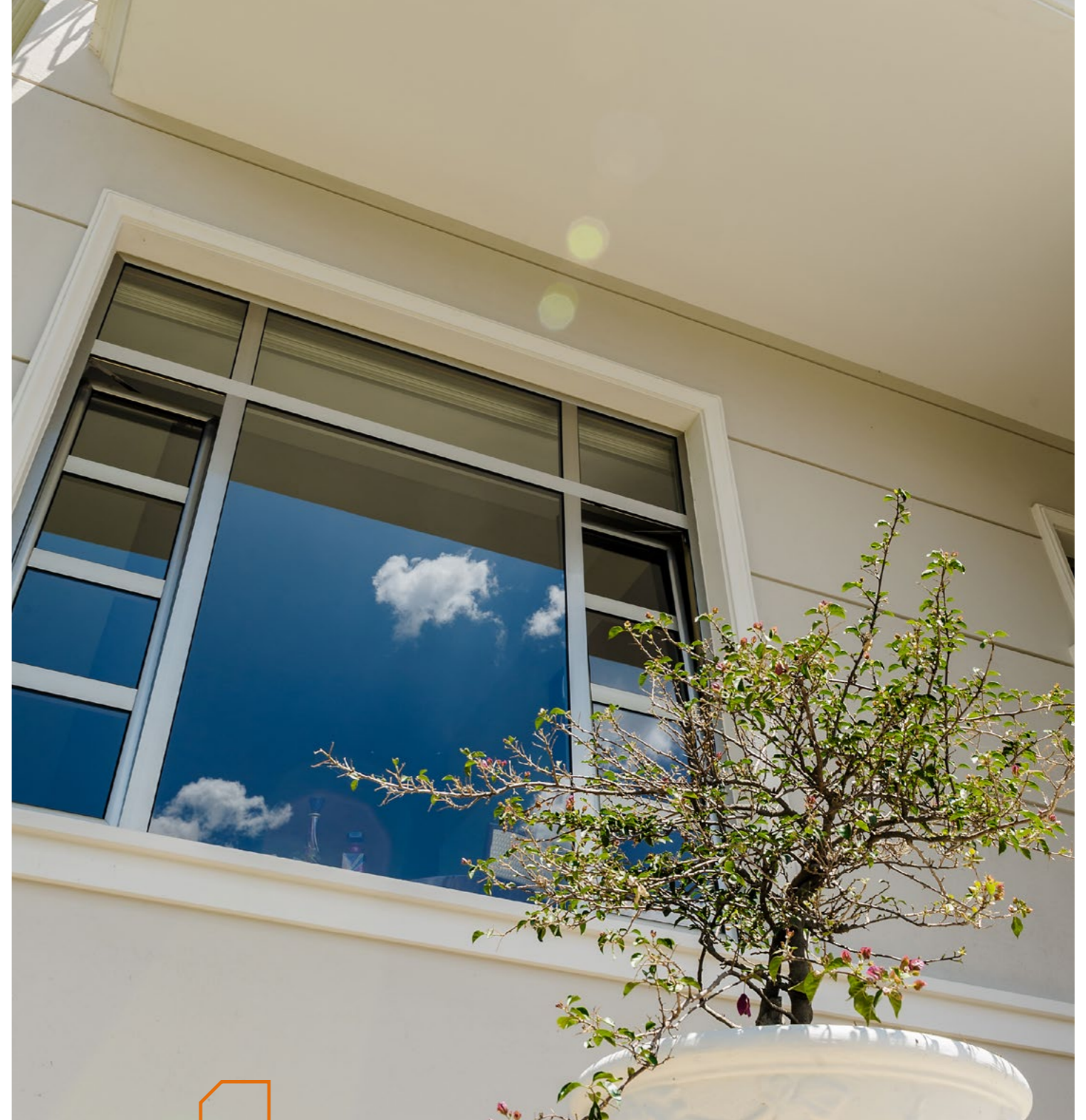

The solution for the most demanding clients

Quality seals



Qualanod seal for the anodization
License number: 1014



Qualicoat seal for the lacquer
License number: 405



Qualideco seal for the imitation wood
License number: ES-0009F

Certification



THERMIA BARCELONA
EN14351-1:2006+A2:2016

Thermia® AF52 C16

Standard 16 Casement Series



Technical features Thermia® AF52 C16	
Thermal break	No
Main frame	45 mm
Main sash	52 mm
Profile thickness	1.5 mm
Maximum glass thickness	27 mm
Maximum glass weight	90 Kg
Tilt and turn leaf maximum weight	100 Kg
Available profiles	Window

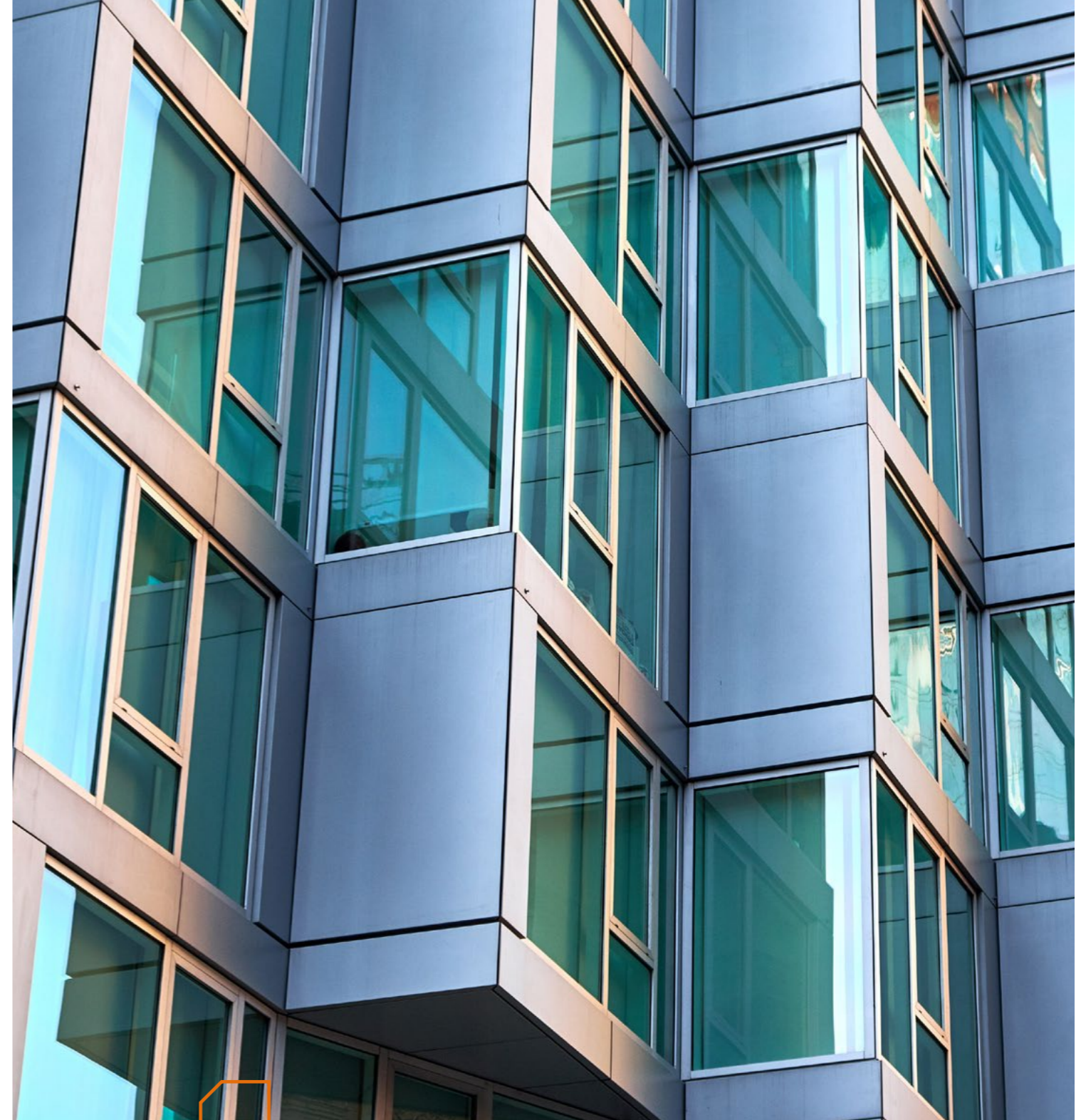

Acoustic attenuation up to 39 dB
(Window size: 1230cm x 1450cm with acoustic laminated glass.)



Thermia® AF52 C16 test results

-  Air permeability **4**
-  Watertightness
Window: **7A** Balcony door: **6A**
-  Wind resistance
Window: **C5** Balcony door: **C4**

Results of official tests performed on Applus and on the basis of Annex E of standard EN-14351-1:2006

Cross-section of Thermia® series AF52 C16

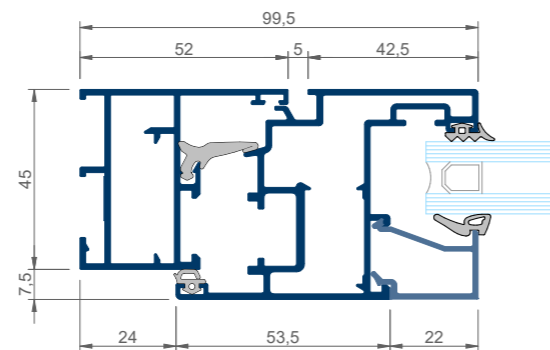

Quality seals



Qualanod seal for the anodization
License number: 1014



Qualicoat seal for the lacquer
License number: 405



Qualideco seal for the imitation wood
License number: ES-0009F

Certification



THERMIA BARCELONA
EN14351-1:2006+A2:2016

Greater comfort with a simple system

Ventanas para vivir mejor

Our product series

Thermia® AR78+ C16

Extreme RPT 16 Casement Series

Technical features Thermia® AR78+ C16	
Thermal break	Yes / 24 mm
Main frame	70 mm
Main sash	78 mm
Profile thickness	1.5 / 1.8 mm
Maximum glass thickness	49 mm
Maximum glass weight	90 kg / door 100 kg
Tilt and turn leaf maximum weight	100 Kg
Available profiles	Window / Door



Uw window = **1.17 W/mk²***

* Based on EN 10077-02 Single-leaf 1.7x2.6 balcony door glass Ug= 0.7 ψ= 0.046

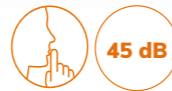

Acoustic attenuation up to 45 dB
(Window size: 1230cm x 1450cm with acoustic laminated glass.)

CASEMENT / Thermia® AR78+ C16

Thermia® AR78+ C16 test results



Air permeability
4



Watertightness
Window: **E1050** Balcony door: **E2100**



Wind resistance
Window: **C5** Balcony door: **C4**

Results of official tests performed on Applus and on the basis of Annex E of standard EN-14351-1:2006

Cross-section of Thermia® series AR78+ C16

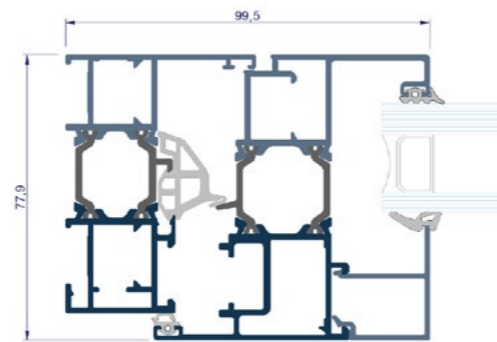

Maximum thermal insulation

Quality seals



Qualanod seal for the anodization
License number: 1014



Qualicoat seal for the lacquer
License number: 405



Qualideco seal for the imitation wood
License number: ES-0009F

Certification



THERMIA BARCELONA
EN14351-1:2006+A2:2016

Windows for a better life

Our product series

Thermia® OC78+ C16

Ocult RPT 16 Casement Series

Technical features Thermia® AR78+ C16	
Thermal break	Yes / 24 - 32 mm
Main frame	70 mm
Main sash	66 mm
Profile thickness	1.5 mm
Maximum glass thickness	28 mm
Maximum glass weight	90 Kg
Tilt and turn leaf maximum weight	100 Kg
Available profiles	Window



Uw window = **1.47 W/mk²***

* Based on EN 10077-02 Single-leaf 1.2x2.4 balcony door glass Ug= 1,1 ψ= 0.053

41 dB

Acoustic attenuation up to 41 dB (Window size: 1230cm x 1450cm with acoustic laminated glass.)

CASEMENT / Thermia® OC78+ C16

Thermia® OC78+ C16 test results

- Air permeability **4**
- Watertightness **E1200**
- Wind resistance
Window: **C5** Balcony door: **C1**

Results of official tests performed on Applus and on the basis of Annex E of standard EN-14351-1:2006

Cross-section of Thermia® series OC78+ C16

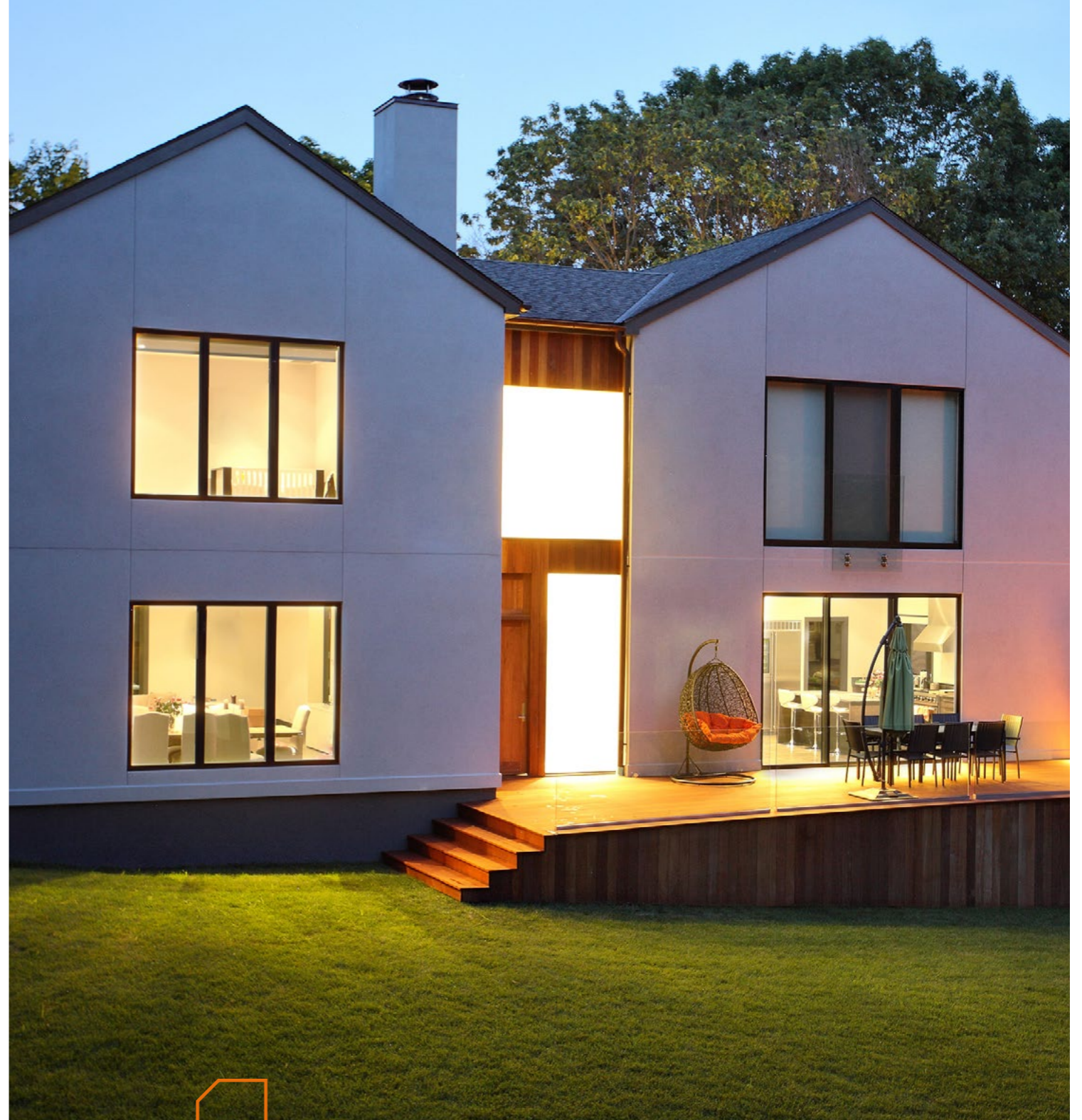
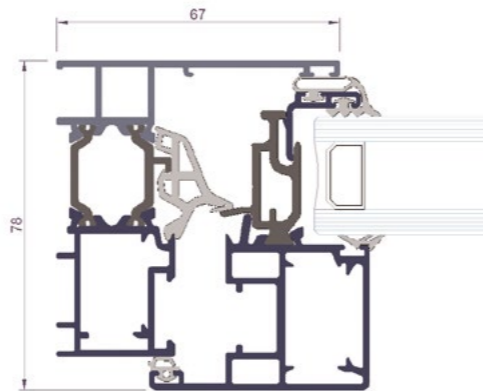

More luminosity with a slim look

Quality seals



Qualanod seal for the anodization
License number: 1014



Qualicoat seal for the lacquer
License number: 405



Qualideco seal for the imitation wood
License number: ES-0009F

Certification



THERMIA BARCELONA
EN14351-1:2006+A2:2016

Windows for a better life

Thermia® CF22

Basic Sliding Series



Acoustic attenuation up to 33 dB
(Window size: 1230cm x 1450cm with acoustic laminated glass.)

Technical features Thermia® CF22	
Thermal break	No
Main frame	35 mm
Main sash	22 mm
Profile thickness	1.2 mm
Maximum glass thickness	8 / 15 mm
Maximum glass weight	80 Kg
Track option	2 tracks
90° frameless closure solution:	No
Available profiles	Window / Door

Thermia® CF22 test results

-  Air permeability **2**
-  Watertightness **C4**
-  Wind resistance **C2**

Results of official tests performed on Applus 15/10169-752 and on the basis of Annex E of standard EN-14351-1:2006

Cross-section of Thermia® series CF22

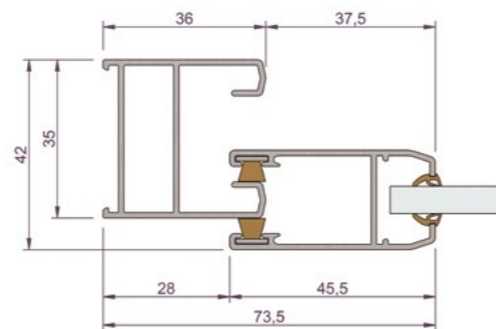

Design and comfort for everyone

Quality seals



Qualanod seal for the anodization
License number: 1014



Qualicoat seal for the lacquer
License number: 405



Qualideco seal for the imitation wood
License number: ES-0009F

Certification



THERMIA BARCELONA
EN14351-1:2006+A2:2016

Windows for a better life

Thermia® CF26

Basic+ Sliding Series



Technical features Thermia® CF26	
Thermal break	No
Main frame	65 mm
Main sash	26 mm
Profile thickness	1.3 mm
Maximum glass thickness	10 / 17 mm
Maximum glass weight	120 Kg
Track option	2, 3, 4 or more tracks
Available profiles	Window / Balcony Door
90° frameless closure solution:	No



Acoustic attenuation up to 36 dB
(Window size: 1230cm x 1450cm with acoustic laminated glass.)



Thermia® CF26 test results

-  Air permeability **3**
-  Watertightness
Window: **5A** Balcony door: **3A**
-  Wind resistance
Window: **C4** Balcony door: **C2**

Results of internal tests performed on the basis of Annex E of standard EN-14351-1:2006

Cross-section of Thermia® series CF26

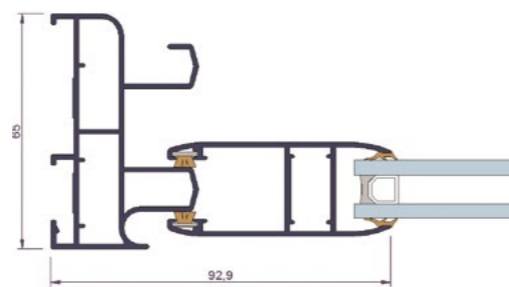

Quality seals



Certification



Extraordinarily versatile windows

Windows for a better life

Thermia® CF31

Standard Sliding Series



Technical features Thermia® CF31	
Thermal break:	No
Main frame:	75 mm
Main sash:	31 mm
Profile thickness:	1.5 mm
Maximum glass thickness:	10 / 31 mm
Maximum glass weight:	160 Kg
Track option:	2, 3, 4 or more tracks
Available profiles:	Window / Balcony Door
90° frameless closure solution:	Yes

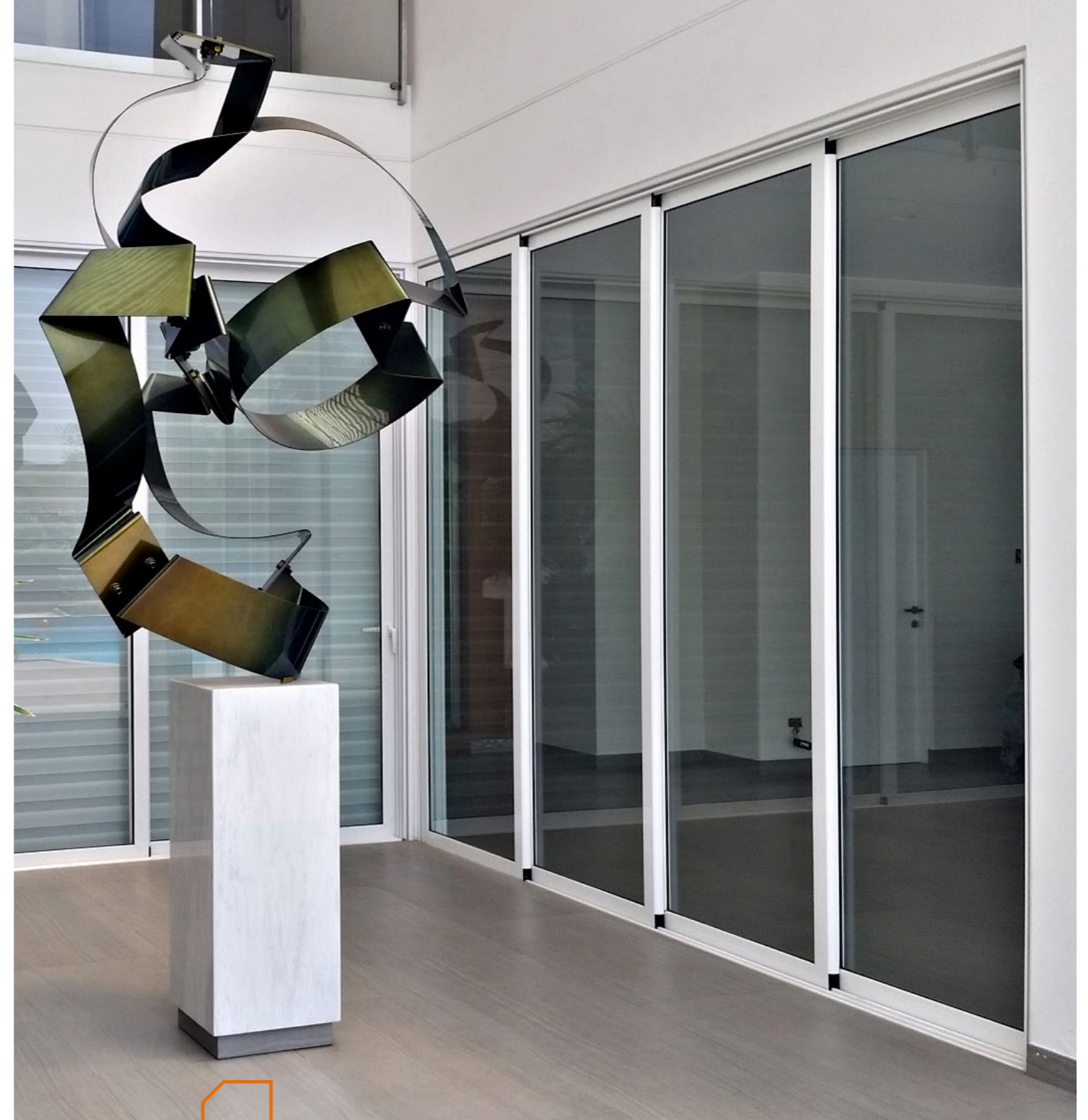

Acoustic attenuation up to 36 dB
(Window size: 1230cm x 1450cm with acoustic laminated glass.)



Thermia® CF31 test results

-  Air permeability **3**
-  Watertightness
Window: **6A** Balcony door: **4A**
-  Wind resistance
Window: **C5** Balcony door: **B1**

Results of internal tests performed on the basis of Annex E of standard EN-14351-1:2006

Cross-section of Thermia® series CF31

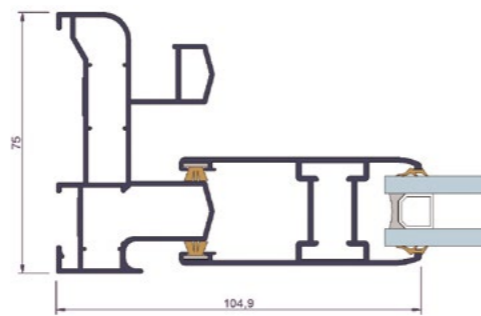

Quality seals



Qualanod seal for the anodization
License number: 1014



Qualicoat seal for the lacquer
License number: 405



Qualideco seal for the imitation wood
License number: ES-0009F

Certification



THERMIA BARCELONA
EN14351-1:2006+A2:2016

Enjoy the outdoors without sacrificing silence

Windows for a better life

Thermia® CF40

Slim Sliding Series



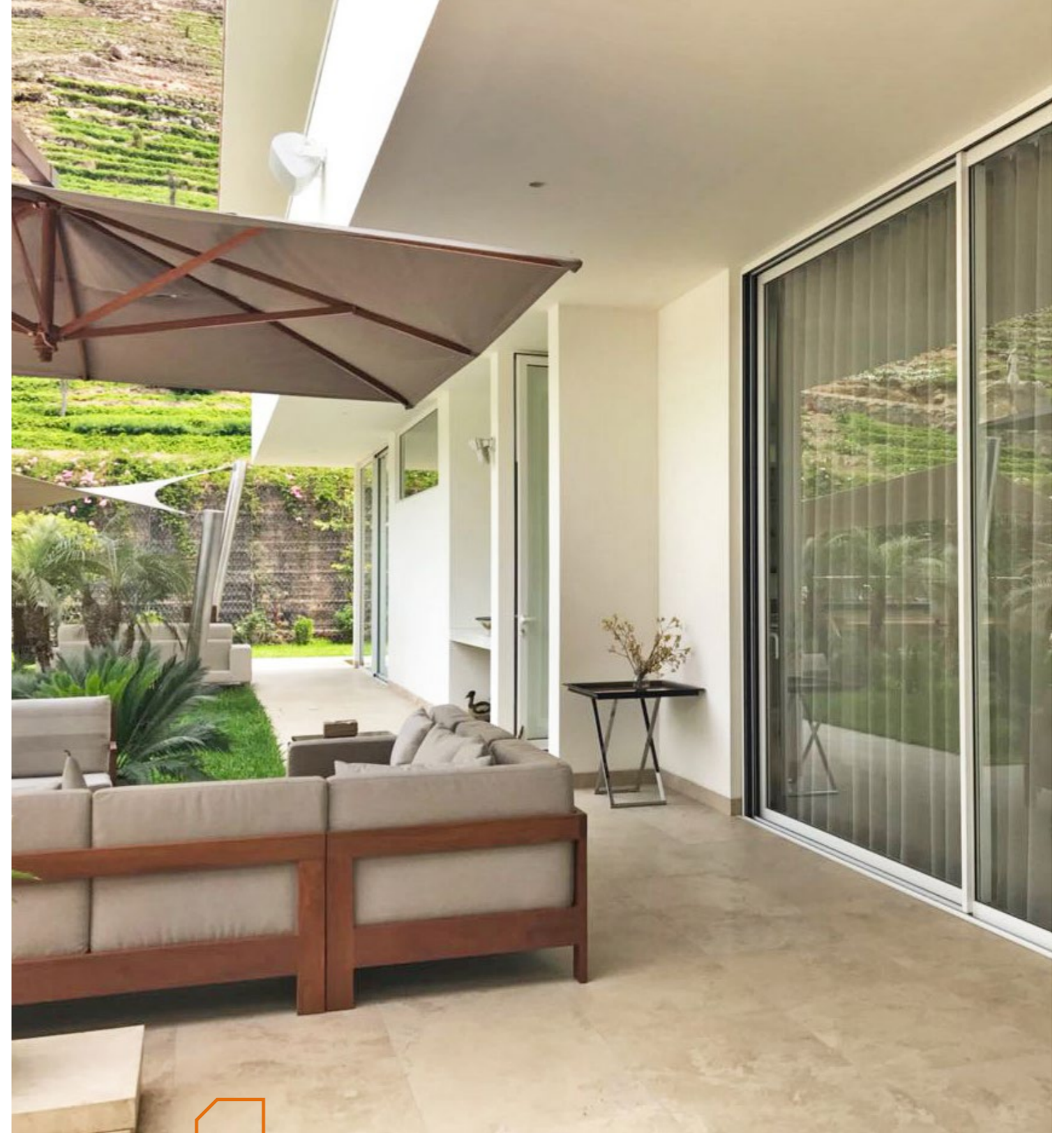

Acoustic attenuation up to 39 dB.
(Window size: 1230 x 1450 with acoustic laminated glass.)

Technical features Thermia® CF40	
Thermal break	No
Main frame	Perimeter cut 65 mm
Main sash	Straight cut 40 mm
Profile thickness	1.4 / 1.6 mm
Maximum glass thickness	28 mm
Maximum glass weight	160 / 200 kg
Track option	2, 3 or more tracks
Available profiles	Window / Balcony Door
Stock colors	White / Silver



Thermia® CF40 test results

-  Air permeability **4**
-  Watertightness **7A**
-  Wind resistance
Window: **C2** Balcony door: **C5**

Results of official tests performed on Ensatec 244728 and on the basis of Annex E of standard EN-14351-1:2006

Cross-section of Thermia® series CF40

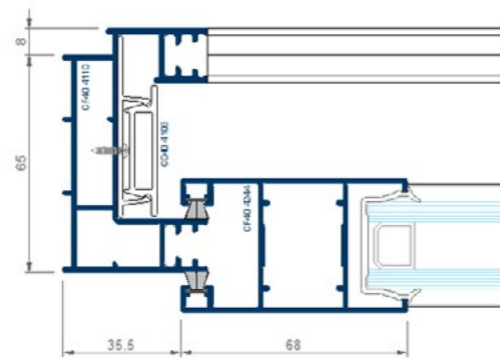

Quality seals



Certification



Sliding windows that can do it all.

Windows for a better life

Our product series

Thermia® CR31

Standard RPT Sliding Series



Technical features Thermia® CR31	
Thermal break	Yes / 14 - 25 mm
Main frame	75 mm
Main sash	31 mm
Profile thickness	1.5 mm
Maximum glass thickness	24 mm
Maximum glass weight	160 Kg
Track option	2, 3, 4 or more tracks
Available profiles	Window / Balcony Door
90° frameless closure solution:	Yes

Uw window = 1.79 W/mk²*

* Based on EN 10077-02 2.8x2.2 balcony door glass Ug= 1.1 ψ= 0.053

37 dB

Acoustic attenuation up to 37 dB (Window size: 1230cm x 1450cm with acoustic laminated glass.)



SLIDING / Thermia® CR31

Thermia® CR31 test results

- Air permeability 3
- Watertightness Window: 6A Balcony door: 4A
- Wind resistance Window: C5 Balcony door: B1

Results of official tests performed on Ensatec 232625 and 232626 and on the basis of Annex E of standard EN-14351-1:2006

Cross-section of Thermia® series CR31

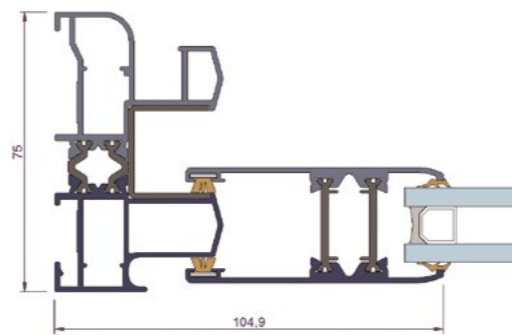

Quality seals

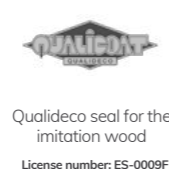

Certification



Windows to bring together the outdoors and the indoors

Windows for a better life

Thermia® CR40

Slim RPT Sliding Series

Technical features Thermia® CR40	
Thermal break	Yes
Main frame	Perimeter cut 65 mm
Main sash	Straight cut 40 mm
Profile thickness	1.4 / 1.6 mm
Maximum glass thickness	28 mm
Maximum glass weight	160 / 200 Kg
Track option	2, 3 or more tracks
Available profiles	Window / Balcony Door
Stock colors	White / Silver





Uw window = 1.58 W/mk²*

* Based on EN 10077-02 3.2x2.4 balcony door glass Ug= 1.1 ψ= 0.053



Acoustic attenuation up to 40 dB
(Window size: 1230cm x 1450cm with acoustic laminated glass.)

Thermia® CR40 test results

-  Air permeability **4**
-  Watertightness **6A**
-  Wind resistance
Window: **C2** Balcony door: **C5**

Results of official tests performed on Ensatec 244728 and on the basis of Annex E of standard EN-14351-1:2006

Cross-section of Thermia® series CR40

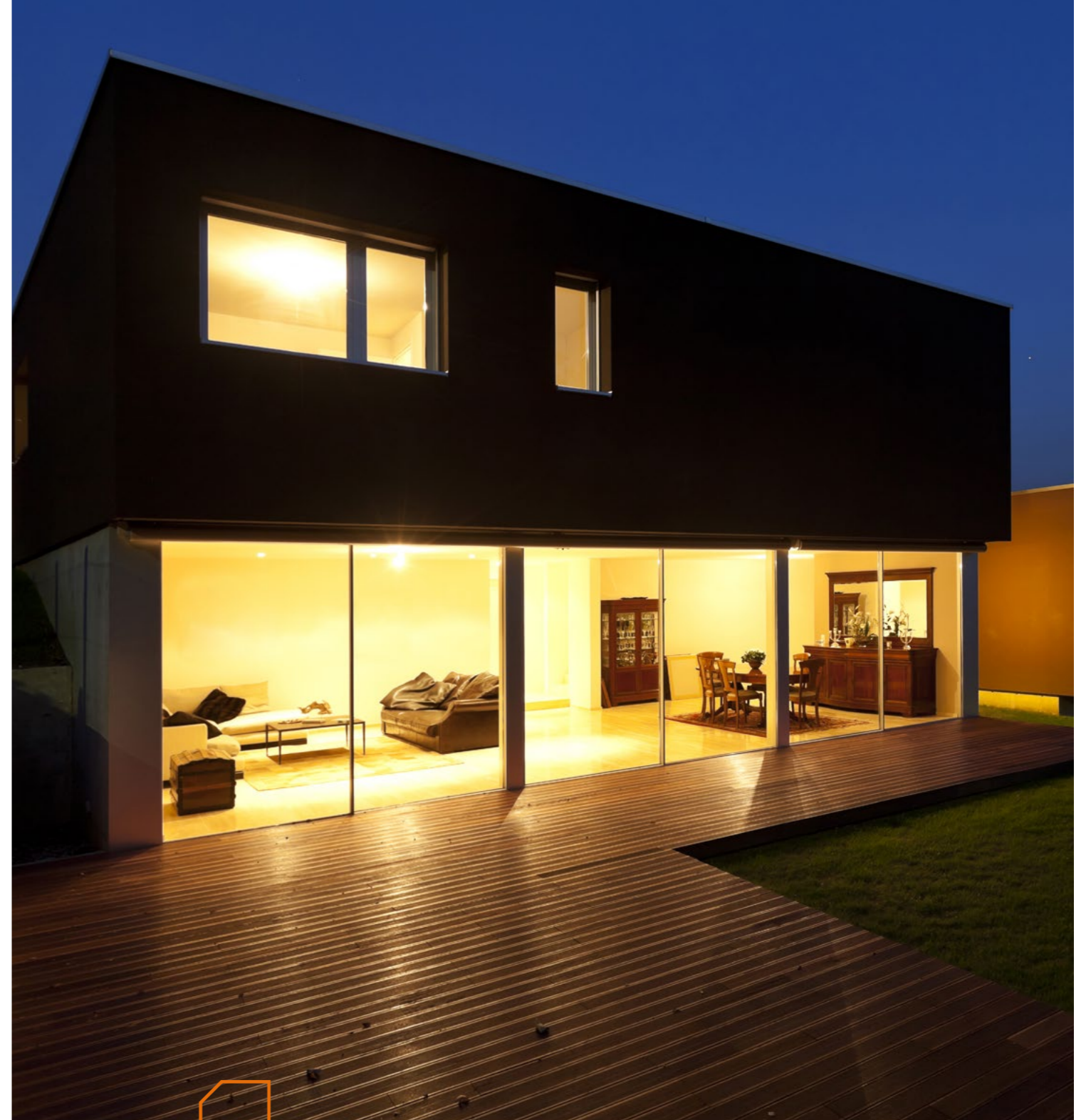
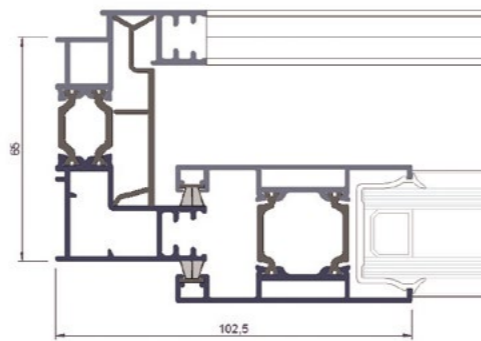

The perfect solution for today's architecture

Quality seals



Certification



Thermia® CR46 MAGNA

RPT Sliding Series

Technical features **Thermia® CR46 MAGNA**

Thermal break	24 mm
Main frame	65 mm
Main sash	46 mm
Profile thickness	1.6 mm
Maximum glass thickness	34 mm
Maximum leaf weight	300 Kg /leaf
Track option	2, 3 or more tracks
Available profiles	Window / Balcony Door
90° frameless closure solution:	Yes



Uw window = **1.60 W/mk²*** Profile Uf = **3.22 W/mk²**



Acoustic attenuation up to 38 dB with acoustic laminated glass of 44.A/cam/44.A composition (window measuring 1230 x 1450)

* Based on EN 10077-02 Balcony Door 2800 x 2250 glass Ug= 1.0 ψg= 0.053



SLIDING / Thermia® CR46 MAGNA

Thermia® CR46 MAGNA test results

- Air permeability **4**
- Watertightness **7A**
- Wind resistance
Window: **C5** Balcony door: **C3**

Results of official tests performed on Ensatec document N° 250712 and on the basis of Annex E of standard EN 14351-1:2006+A2:2016

Cross-section of Thermia® series CR46 MAGNA

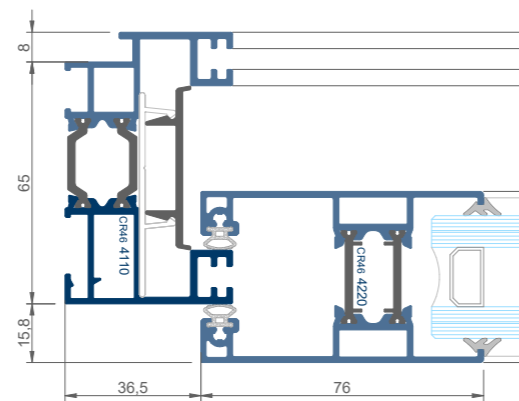

Quality seals



Certification



Connect with the outdoors

Windows for a better life

Thermia® ER52

RPT Lift & Slide

Technical features Thermia® ER52	
Thermal break:	Yes / 24 - 14 mm
Main frame:	125 mm
Main sash:	52 mm
Profile thickness:	1.8 mm
Maximum glass thickness:	30 mm
Maximum glass weight:	350 Kg
Track option:	2 or 3 tracks
Available profiles:	Window / Balcony Door
90° frameless closure solution:	No

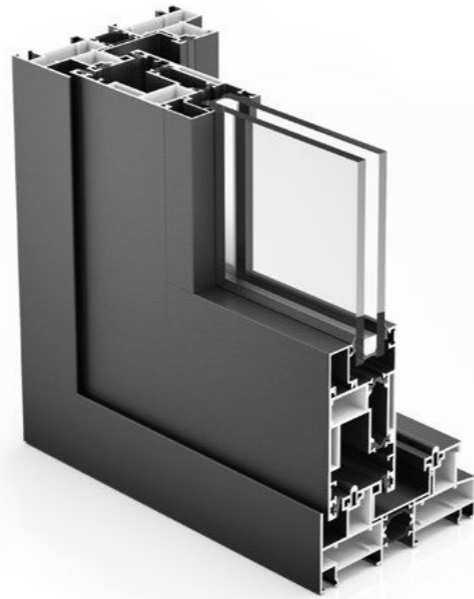

Uw window = 1.84 W/mk²*

* Based on EN 10077-02 4.5x2.8 balcony door glass Ug= 1.1 ψ= 0.053



Acoustic attenuation up to 44 dB
(Window size: 1230cm x 1450cm with acoustic laminated glass.)

Thermia® ER52 test results

-  Air permeability 4
-  Watertightness 7A
-  Wind resistance C3

Results of official tests performed on Applus 10/323000370 - 09/32302504 - 09/32302670 and on the basis of Annex E of standard EN-14351-1:2006

Cross-section of Thermia® series ER52

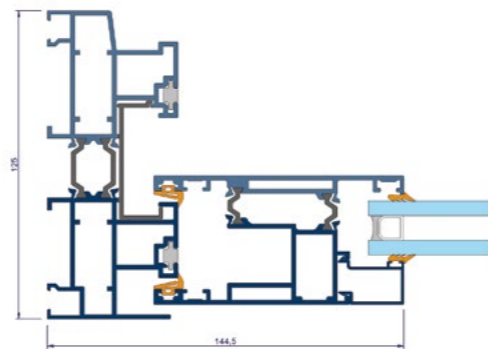

Size is not a problem

Quality seals



Qualanod seal for the anodization
License number: 1014



Qualicoat seal for the lacquer
License number: 405



Qualideco seal for the imitation wood
License number: ES-0009F

Certification



THERMIA BARCELONA
EN14351-1:2006+A2:2016

Windows for a better life

Thermia® Shutter Series
with 4 kinds of slats and glass.

Thermia® PM

Sun & sight protection and security series

Fixed slat shutter

The solution for sun protection and ventilation, protecting the privacy of guests.



Blind slat shutter

The solution for achieving a totally opaque and reinforced surface. Allows no light to enter.

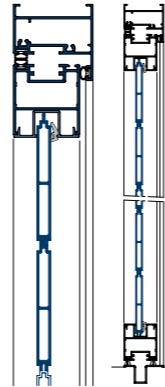

Movable slats shutter

Slat position can be adjusted, allowing the user to position them as desired at any time.



Glass slide & folding

Commonly used with exterior and interior folding closures, for dividing interior space.

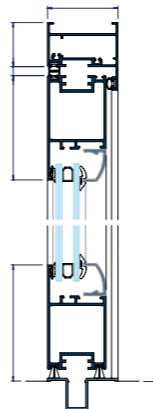

Mediterranean style
Thermia® Shutter

The Thermia® shutter takes its inspiration from the ancient wooden shutters that adorn many buildings in cities and towns throughout the Mediterranean area.

More than a simple decorative facade, it offers ideal protection against the sun's rays as well as home burglaries.

Its extruded aluminum construction is perfect for achieving a stronger, longer-lasting and maintenance-free product.

The huge variety of solutions offered in this series allows you to choose the best option for any construction style.

Design
Comfort
Silence

Thermia® PM

Sun & sight protection and security series

Opening systems

Sliding shutter system

- The sliding shutter is the perfect solution for sun protection on the facade of a building. Its lateral movement allows for the fabrication of 1, 2, or more panels, with multiple trucks.
- The wall guide is manufactured with a decorative cover for a more elegant look.
- The ability to slide all the panes laterally means that the window opening can be left completely unobstructed.

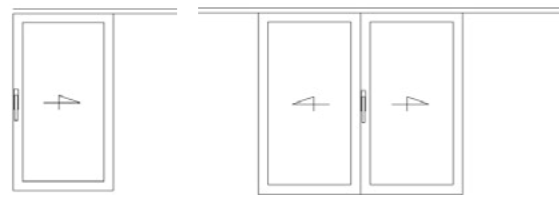

Single panel Double panel

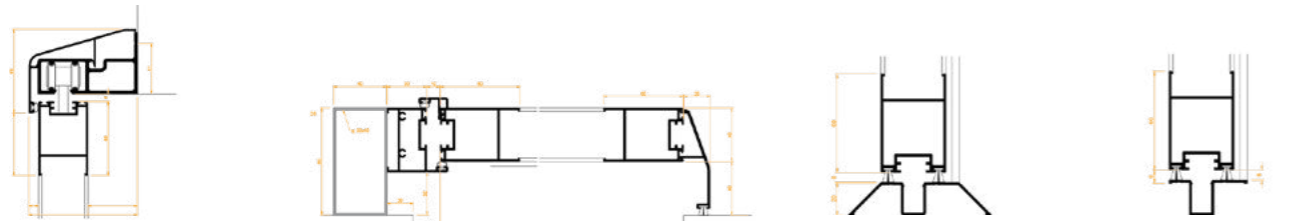

Wall guide with decorative cover Cross-section single panel Overlapping lower guide Embedded lower guide

Folding shutter system

- The ideal closure for restaurants, bars, pool areas, meeting rooms, etc.
- Either glass or slats can be mounted in its frames.
- Multiple combinations (Fig. 1)

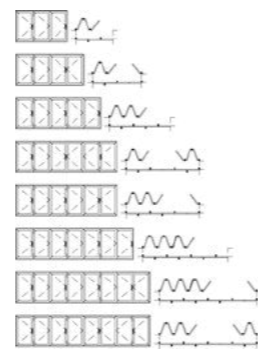

(Fig. 1)

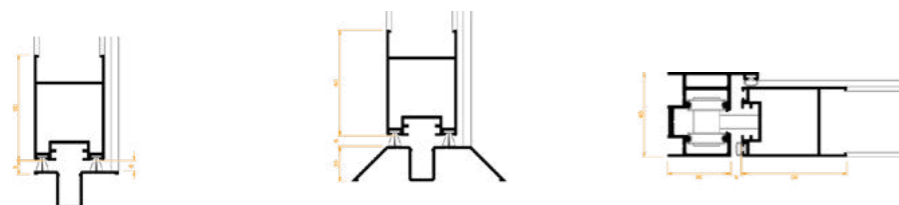

Recessed lower guide Overlapping lower guide Upper ceiling guide

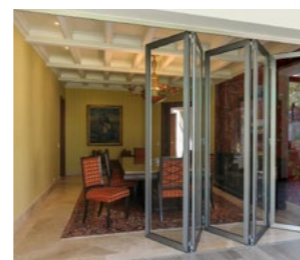

Windows for a better life

Caseament shutter system

- The frame rotates to an open position on a vertical axis, using hinges.
- Allows for up to 4 panels to be installed, with different opening solutions.
- Combinations (Fig. 2)
- The panes can open to the outside or the inside, as needed.

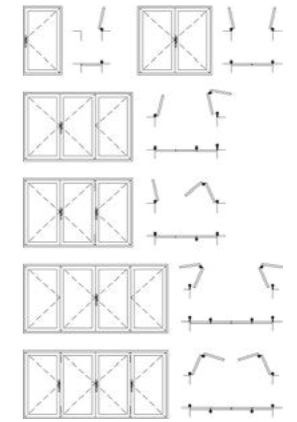

(Fig. 2)



Cross-section single panel

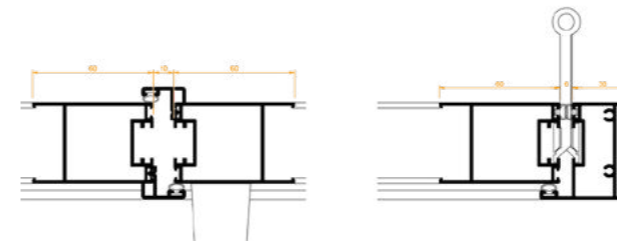

Cross-section double panel



The aluminum shutter serie is ideal for:

- Decoration of the facade.
- Greater protection against robbery.
- Solar protection in buildings and residences.



Thermia® MQ22

Mosquitoes screen

Insect protection series

A versatile system offering effective protection against mosquitoes.

- + Casement, sliding, or fixed structure opening systems.
- + Manufactured with 1, 2, 3 or more panels.
- + Manufacture of large-format balcony doors.



Windows for a better life

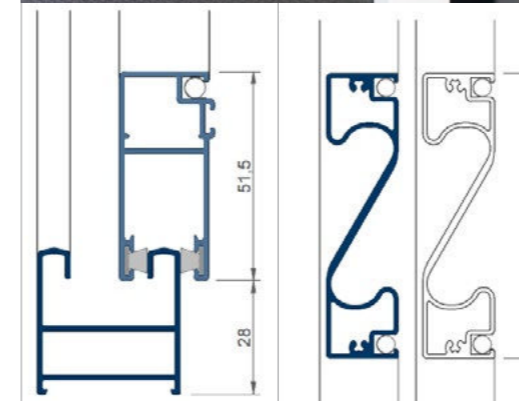
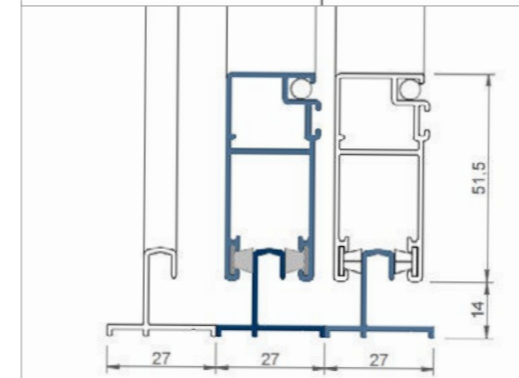
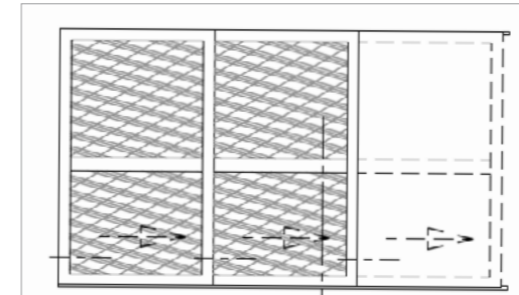

A **unique system** in the market for **large-format balcony doors.**

Thanks to the use of robust profiles and the assembly system, large-format panels can be assembled with whatever combination works best.

While other products on the market have a very short useful life, The Thermia MQ22 mosquito screen has been specially designed to last a long time in large openings.

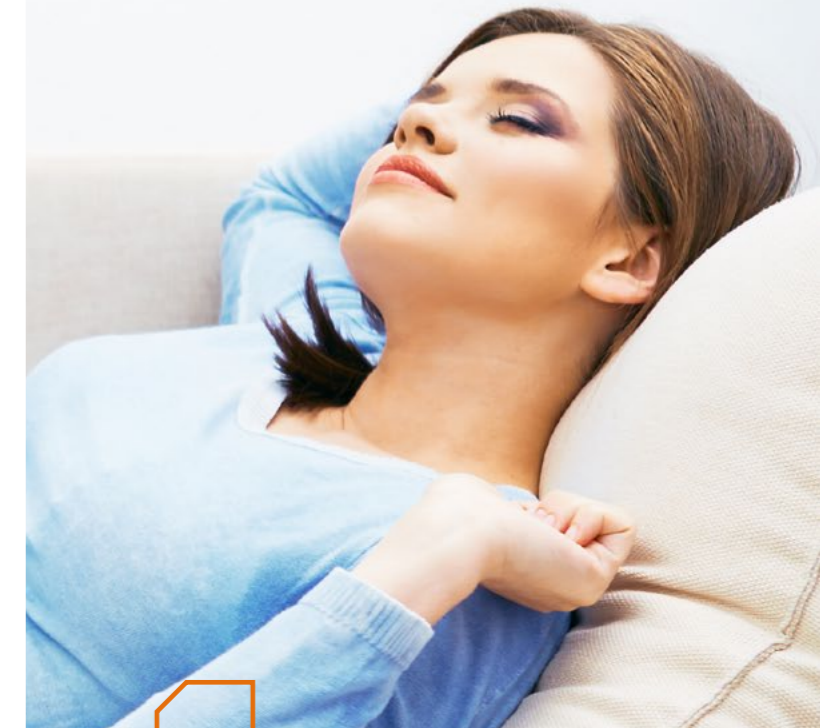

Protection against insects.

Thermia® MQ22

MOSQUITO PROTECTION / Thermia® MQ22



Maximum robustness

A system of tubular profiles joined by machined corner joints on the profile and robust, high-quality components to ensure a long useful life.

Impeccable aesthetics

Unlike most mosquito screen system sold on the market, Thermia® MQ22 uses aluminum corner joints on tubular profiles to create frames and sash joined at 45° (like a window), avoiding flimsy plastic components that deteriorate quickly.

Easy to manufacture and install

Highly intuitive manufacture and installation All you need are the same fixtures and accessories used with the Thermia Barcelona® windows series.

100% Adaptable

This series is fully adaptable to the Thermia Series and to any other window on the market.



Thermia® AF52M Mullion

Light structural series

Technical features Thermia® AF52M - Mullion
Compatible with the Thermia® AF52 series, an upright and crossbeam system measuring 85 mm and 125 mm.
Glass panes supported mechanically by the moldings of the Thermia system.
Wide range of glazing.
Ability to mount outward-opening sash from the AF52 series.
Ability to attach any sliding or casement window from the Thermia system to the uprights.
Option of internal steel reinforcement to increase strength (ExY module).
Many combinations can be achieved by attaching a screw-on blades or glazing bead in multiple positions.

Inertias

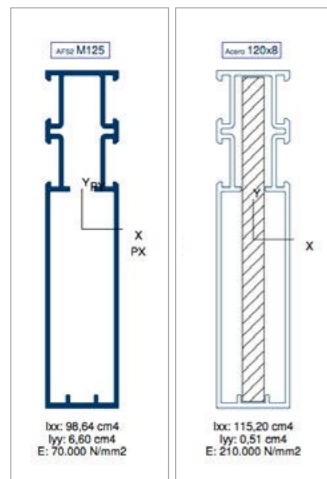

Non-reinforced Reinforced

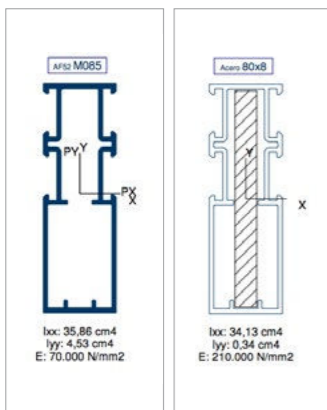

Non-reinforced Reinforced

Cross-section

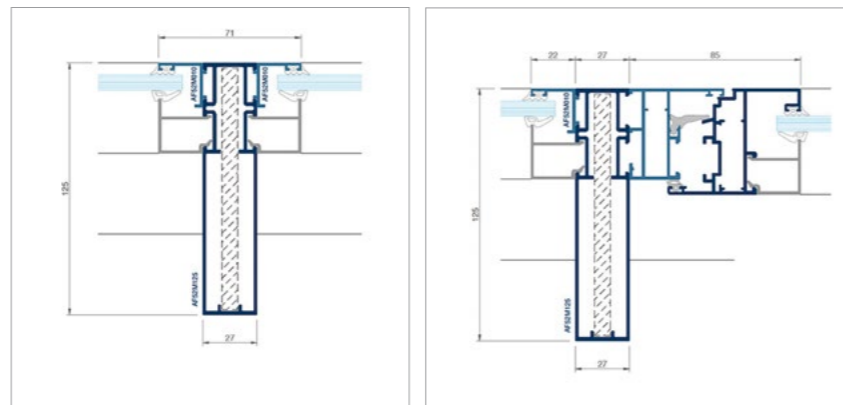

Cross-section fixed structure - fixed structure Cross-section fixed structure - inward opening

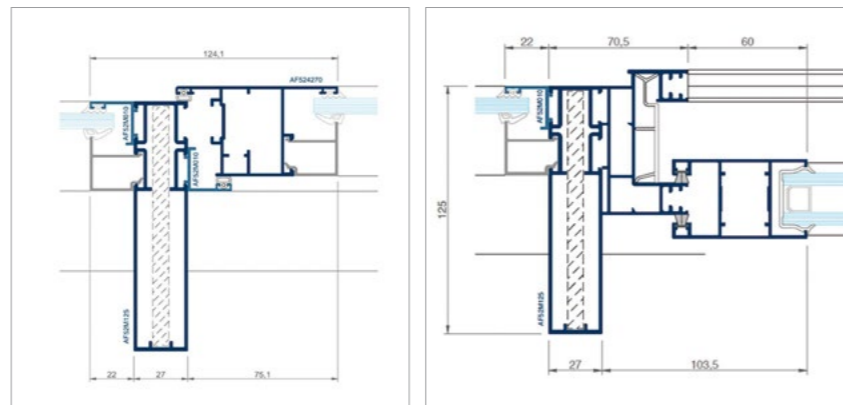

Cross-section fixed structure - outward opening Cross-section fixed structure - sliding opening



Quality seals

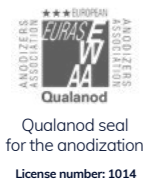

Qualanod seal for the anodization
License number: 1014



Qualicoat seal for the lacquer
License number: 405



Qualideco seal for the imitation wood
License number: ES-0009F

Certification



DIMAC SL 2018 Accessories
EN 1435-1: 2006
THERMIA BARCELONA® SERIES

Thermia® AF52M Series

The Thermia® Series AF52M is a light structural system made up of 85 mm and 125 mm mullion, conceived for projects with different reinforcement requirements.

Thermia® GR48

Glass rail series



Tests

Usage categories

A1	A2	B	C1	C2
C3	C4	C5	E	F

Security testing:
CTE - DB SE-AE section 3.2.
Actions on handrails and dividing elements.

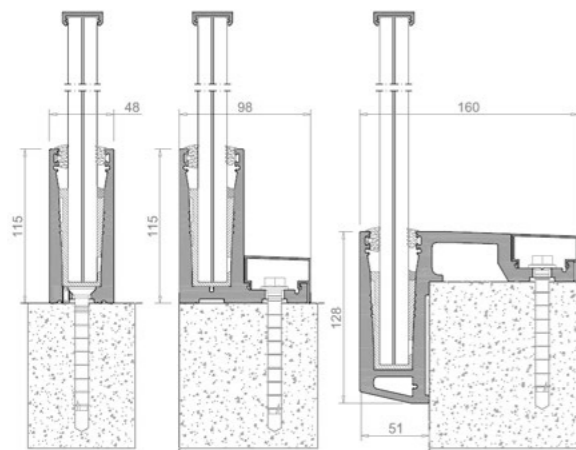

Performance

Usage categories certified for compliance with standards CTE-DB SE-AE

	6+6 // (T)	8+8 // (T)	10+10 // (T)
	✓ A,C1y2,D,G (Doc. 243812) (1285mm altura)	✓ C3y4,E,F (Doc. 242398) (1150mm altura) ✓ A,C1y2,D,G (Doc. 243819**) (1285mm altura)	✓ C5 (Doc. 242398) (1150mm altura)
	✓ A,C1y2,D,G (Doc. 243813) (1130mm altura)	✓ C3y4,E,F (Doc. 242398) (1130mm altura) ✓ A,C1y2,D,G (Doc. 243819**) (1130mm altura)	✓ C3y4,E,F (Doc. 242398) (1300mm altura)
	✓ A,C1y2,D,G (Doc. 242914) (1105mm altura)	✓ C3y4,E,F (Doc. 243118) (1250mm altura) ✓ A,C1y2,D,G (Doc. 243819**) (1285mm altura)	✓ C5 (Doc. 242397) (1105mm altura) ✓ C3y4,E,F (Doc. 243118) (1300mm altura) ✓ A,C1y2,D,G (Doc. 242914**) (1210mm altura)
	✓ A,C1y2,D,G (Doc. 242915) (1180mm altura)	✓ C3y4,E,F (Doc. 243811) (1180mm altura) ✓ A,C1y2,D,G (Doc. 243819**) (1180mm altura)	✓ C3y4,E,F (Doc. 243278) (1110mm altura)

*Verificació amb laminat

NOTE 1:
Usage category C5 covers cases C3, C4, E and F.
NOTE 2:
Usage category C3 and 4, E, F covers cases A, C1, C2, D and G.

Minimalist security

Thermia® GR48

Extrusion alloy

- 6060.

State of supply

- T6 - T66.

Dimensions

- Profile depth 48 mm.
- Cross-section view 115 mm.

Construction options

- On the floor.

- On the edge of the floor.
- Recessed.

Glazing

- 6+6 T (Butyrals)
- 8+8 T (Butyrals)
- 10+10 T (Butyrals)

Principal characteristics

- CTE - DB SE-AE approval for all usage categories*.

- Double anti-lift system for glazing.

- Protective seating for glass, with impact resistance and high load-bearing capacity.

- Mechanical adjustment for leveling on the floor.

- Compatible with alignment strings and connecting angles.

- Integrated water drainage, caps and external anodic protection.

Quality seals



Qualanod seal for the anodization
License number: 1014



Qualicoat seal for the lacquer
License number: 405



Qualideco seal for the imitation wood
License number: ES-0009F

Certification



THERMIA BARCELONA
EN14351-1:2006+A2:2016

Our product series

Thermia® Railing

Railing series

Assembly options

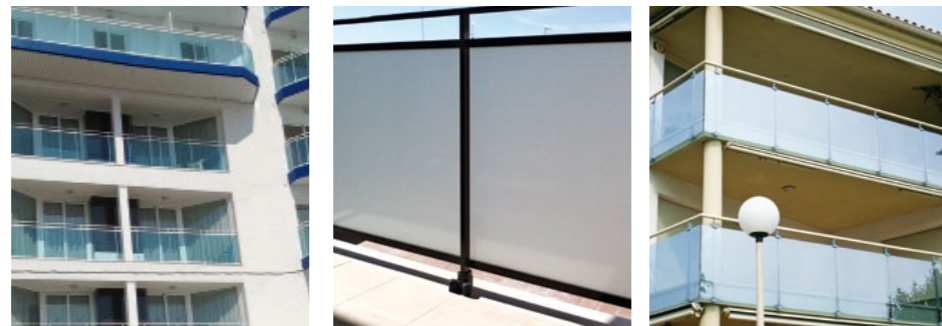
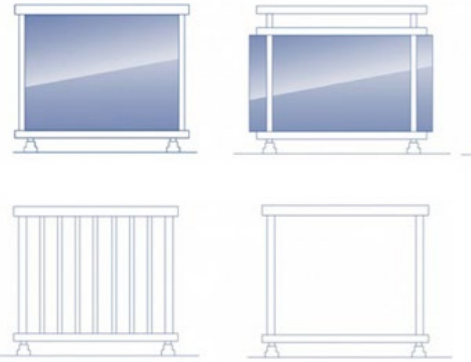

Safety and elegance

Thermia® Railing

The wide variety of combinations of aluminum profiles and accessories make Thermia Barcelona® railing a safe, versatile and simple construction component that can be decorated with the same technologies used with the windows.

Quality seals



Qualanod seal for the anodization
License number: 1014



Qualicoat seal for the lacquer
License number: 405



Qualideco seal for the imitation wood
License number: ES-0009F

Certification



THERMIA BARCELONA
EN14351-1:2006+A2:2016

Windows for a better life

Thermia® Louvers

Solar protection series

Ventilation system with varying distances between slats.

- + -10 mm, 0 mm, 10mm.
- + Slat thickness 1.4 mm.
- + Clip fastening system.

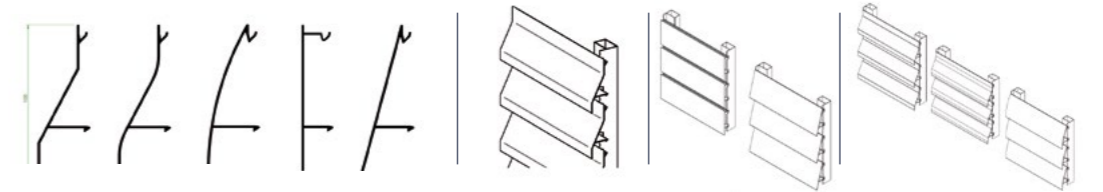
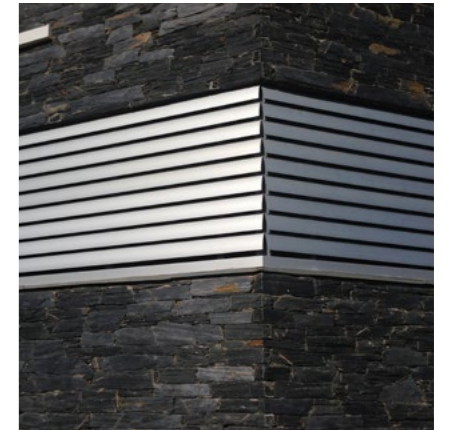

VELAM LOUVRES

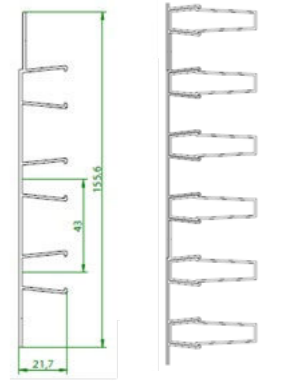
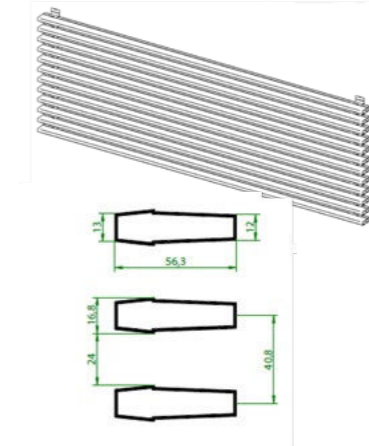

Protection and ventilation

Thermia® Louvers

A ventilation and sun protection system for facades, using horizontally fastened slats. The surface can be treated with whatever color fits the architecture as a whole.

Design
Comfort
Silence

Manufacture Thermia® Windows anywhere in the world.

Our Thermia® systems distribution division serves window manufacturers, offering the following advantages to metal carpentry workers:

Comprehensive service to manufacturers

- + Optimization of inventory of Thermia® profiles and accessories.
- + Specific tools for optimal manufacture of Thermia® window.
- + Specialized carpentry software, customized for your use.
- + Start-up and after-sale service.
- + Comprehensive logistics service and tracking of goods.
- + Ongoing training in the manufacture of Thermia® system.
- + Corporate communication and marketing support.
- + Ongoing technical and business consulting.

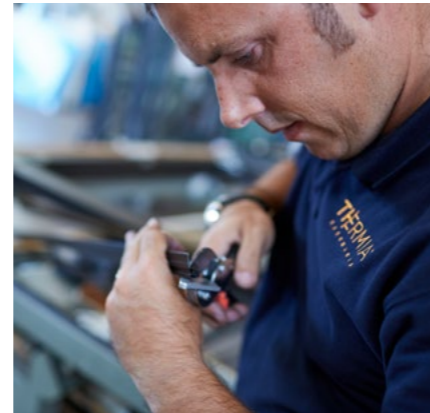

Thermia® window manufacturers benefit from optimized inventory management, personalized technical support and business consulting for all Thermia® systems.

“We offer a comprehensive, fully customized service”



The Thermia® systems distribution network

- + Marketing to **domestic manufacturers.**
- + Marketing to **international manufacturers.**

Windows for a better life

Manufacture or install Thermia® anywhere in the world

Install Thermia® windows.



Comprehensive service to installers:

- + Ongoing technical and business consulting.
- + Fast delivery service.
- + Comprehensive logistics service and tracking of goods.
- + Corporate communication and marketing support.

Our manufactured window division allows window installers to purchase Thermia® doors and windows with whatever technical and aesthetic features they need.



Trained professionals in Thermia® windows manufacture, will create whatever closures are requested **under CE regulations.**

In order to guarantee quality, Thermia® closures undergo thorough quality control for:

- Functionality of components.
- The airtightness of the system.
- Surface finishes.

Wholesale Thermia® windows manufacturers:

Service to all companies in the construction, architecture, and remodeling industries:



Design
Comfort
Silence

Windows that measure up to the latest environmental trends: energy efficiency.

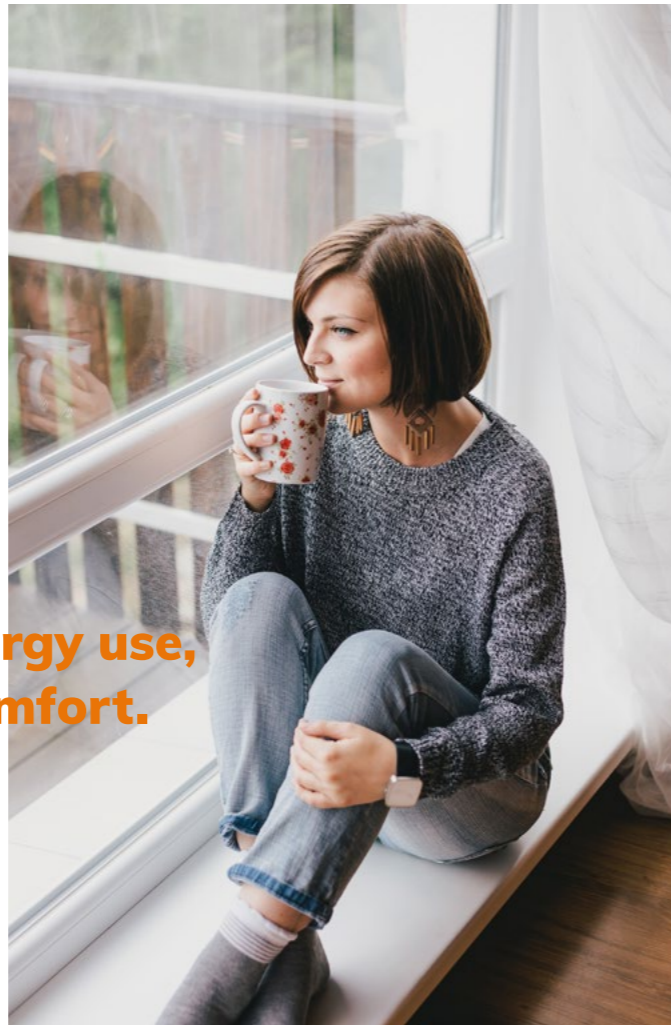

Less energy use, more comfort.

The maximum thermal insulation of a building is directly related to the resistance capacity of the elements that are in contact with the outside environment: windows

doors, exterior walls and roofs. To achieve optimal energy efficiency, suitable insulating materials must be installed on the building envelope.

Windows for a better life



A well-insulated house can save up to 50% on energy consumption.

Windows and energy efficiency

The windows are the most vulnerable part of a residence.



As part of the fight against energy waste and worldwide CO2 emissions, European authorities connected to the construction industry have established strict and mandatory directives on energy efficiency, which must be applied to buildings and which are found in the Basic Energy Saving Document (DB HE) as an extension to the current Technical Building Code (CTE).

This new legal framework affects both new construction and existing buildings in the process of being sold or leased.

At Thermia Barcelona® **thermal insulation is one of the highest priority goals** in the design and manufacture of doors and windows. We know that controlling the temperature and humidity inside homes is key to providing the comfort and well-being that we all want.

Design
Comfort
Silence

How the noise pollution affect our health and comfort and how insulated windows can help us.

Noise pollution is an affliction that affects everyone who lives in major cities. The noise of cars and motorbikes, helicopters and planes remain excessive and annoying sounds that we continue to hear and which affect our health on a daily basis.

In fact, traffic is the main source of noise pollution. A constant sound that hardly ever stops seems to envelop everywhere we go (work, walking around town, the home, etc.)

If you live near to a road with traffic, sleeping or simply the peace of mind of being at home can be a difficult task and often an irritating one.

Being able to rest at home should be routine, but that is not the case for many millions of people.

And then there is sleep. Getting a good night's sleep can become a nightmare if noise penetrates our entire room. And getting the recommended sleeping hours is vital for our well-being and health.

The WHO (World Health Organization) establishes the maximum levels at 50 dB-60 dB (decibels) and warns that higher exposure can be seriously harmful.

As an example, the noise of a vacuum cleaner is already at 65 dB, a normal conversation is 50 dB and rustling of leaves is 20 dB. It is important to try to lower the decibels in our homes to guarantee a more peaceful house, places to rest and to alleviate tension accumulated during the day. Ultimately, our home is our temple. Shouldn't it be a place of rest and happiness?

Windows for a better life



According to the WHO (World Health Organization) it establishes the **maximum levels at 50-60 dB (decibels)** and warns that higher exposure can be seriously harmful to our health.



Psychological health specialists state that peacefully benefiting from sleep time translates to greater effectiveness on a work and emotional level.



Noise-related illnesses include hearing loss, learning problems, strokes, respiratory diseases, stress and irritability or neurosis, hysteria and psychosis.

Regardless of the government campaigns to draw up action plans to control and prevent sound contamination in streets and common areas, the fact is that people currently continue to endure pollution damage on a daily basis.

It is not possible to halt the consequences of these pollution indices in public areas in the short term, but we can in our homes.

If we can insulate our home against the constant outside noise, we will be able to im-

prove the quality of our lives, increase our comfort and, above all, ensure that our health is protected.

One of the best options for living with peace and quiet at home is insulated (thermo-acoustic) windows that protect on the one hand against outside noise, and on the other against the cold and heat depending on the time of year.

Design
Comfort
Silence

Windows for a better life

The importance of glass in acoustic attenuation.

Studying the phonic performance of a window, we can find the factors that determine the effectiveness of acoustic attenuation:

Tempered or laminated glass (not acoustic) do not alter the acoustic properties.

However, acoustic laminated glass attenuates more than the same thickness of float glass.

The window must guarantee the maximum possible air-tightness.

Any minor crack in the closure represents an air inlet and, therefore, noise.

Different thicknesses of insulated glass attenuate more than insulated glass with the same thickness.

The thicker the glass, the greater the attenuation.

It is advisable to fit thicker glass, keeping in mind its weight (2.5 kg per m² and mm of thickness).

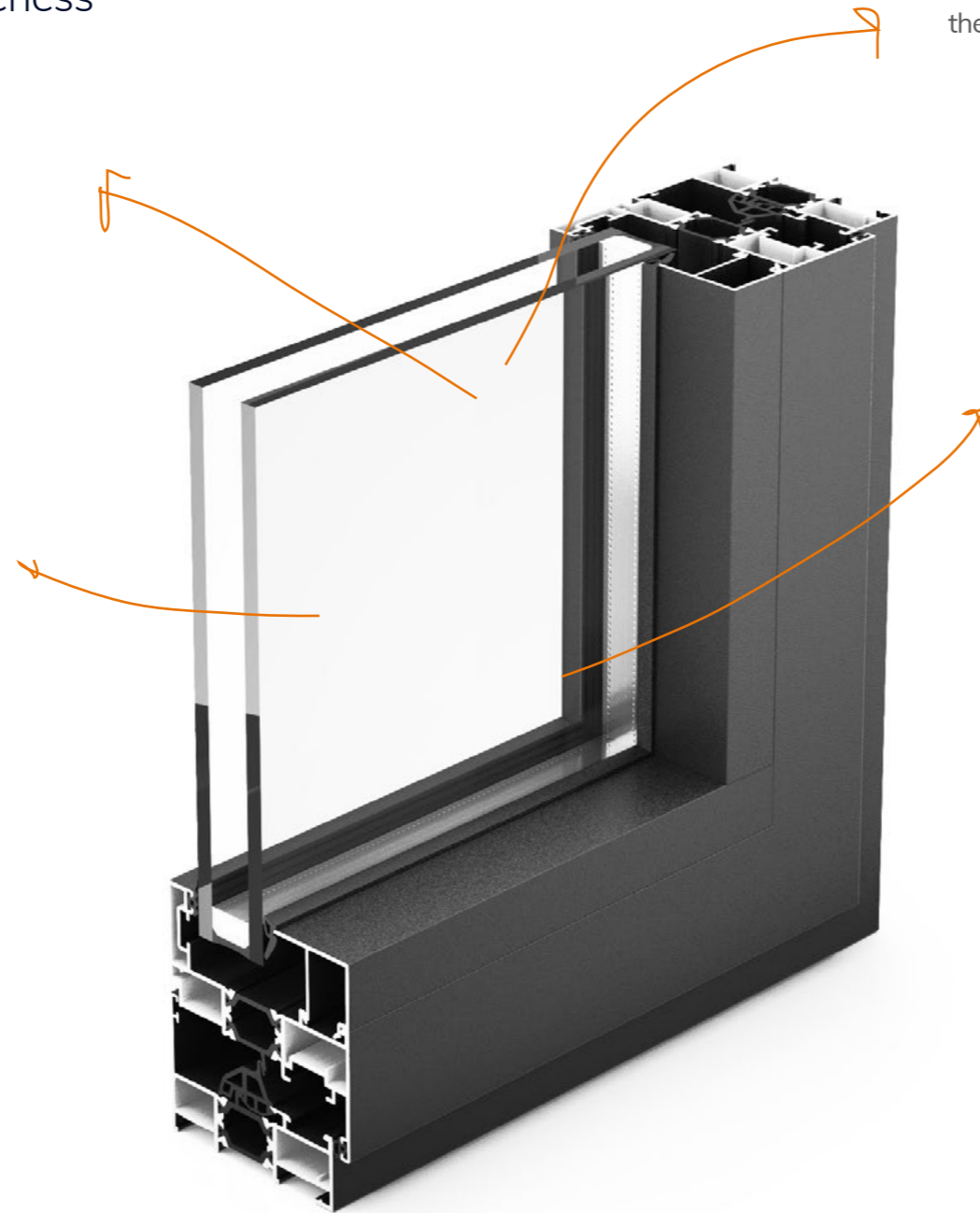

The **solution** at home: **Installing airtight windows** that insulate against the outdoors.

Thermia Barcelona® thermo-acoustic windows offer high acoustic and thermal insulation in homes. They feature high airtightness, ideal for combating noise issues, dust and changes in temperature.

Composition		Rw	C	Ctr
Monolithic	3	28	-1	-4
	4	29	-1	-2
	6	31	-1	-2
	10	34	-1	-2
Laminated	33.1	31	0	-1
	44.1	34	0	-1
	66.1	37	0	-2
Acoustic laminated	33SC	33	-1	-2
	44SC	31	-1	-3
	66SC	35	-1	-2
Monolithic	4/12/6	33	-1	-3
	5/12/5	31	-1	-4
	6/12/8	35	-1	-3
Laminated monolithic	5/12/33	36	-1	-5
	5/12/44	36	-1	-4
	10/12/66	39	-1	-3
Acoustic laminated monolithic	6/12/44SC	39	-1	-5
	6/12/66SC	41	-1	-3
Acoustic monolithic acoustic laminated	44SC/12/66SC	45	-1	-5

Glass composition and its acoustic attenuation.

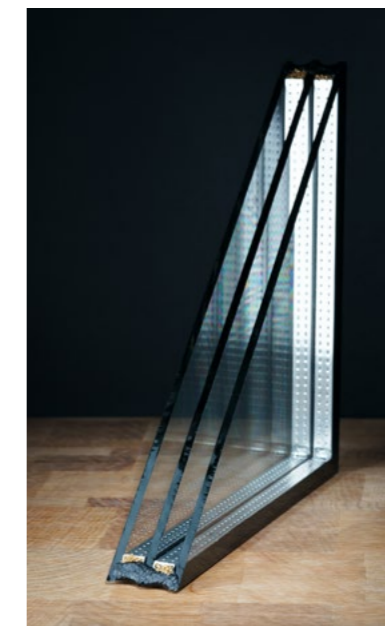

ACOUSTIC NOISE TABLE

- 100 dB Ambulance siren.
- 90 dB Noisy road traffic.
- 80 dB Noisy street.
- 70 dB Quiet road traffic.
- 60 dB Restaurant. Store.
- 50 dB Quiet street.
- 40 dB Living room.
- 30 dB Bedroom. Quiet refrigerator.
- 20 dB Quiet rustling of tree leaves.
- 10 dB Quiet breathing.

16 mm Cave series

AF52

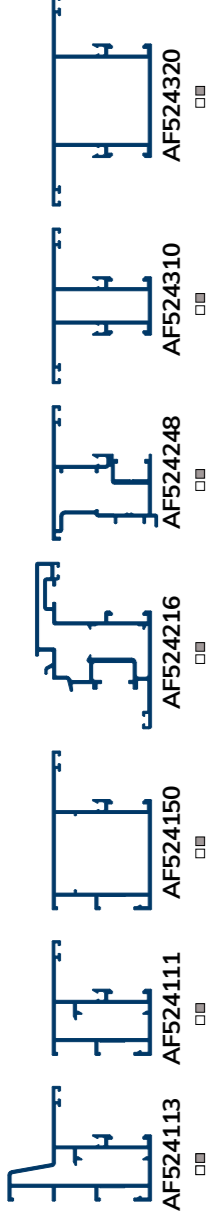

AF524113 AF524111 AF524150 AF524216 AF524248 AF524310 AF524320

AR78+

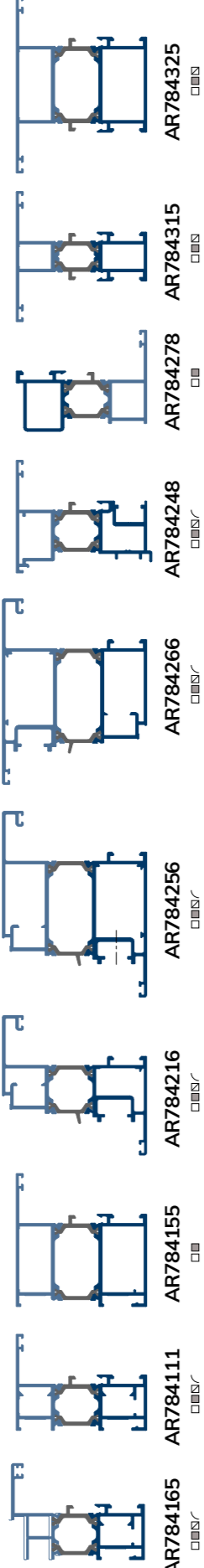

AR784111 AR784155 AR784216 AR784256 AR784266 AR784278 AR784315 AR784325

OC78+

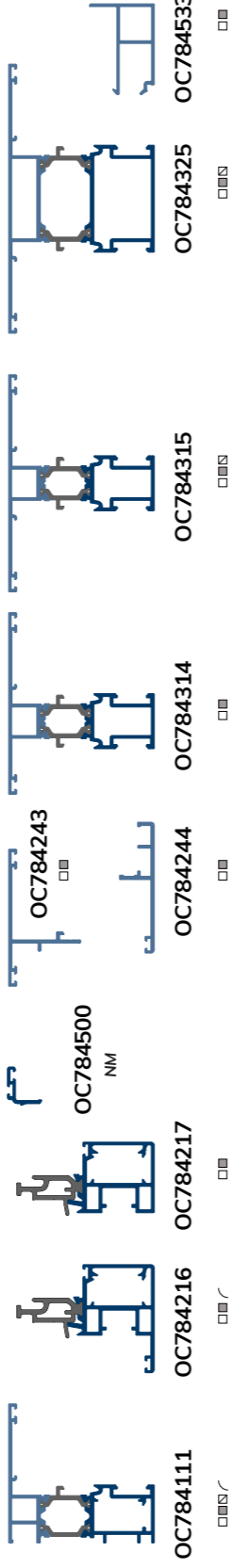

OC784111 OC784216 OC784217 OC784243 OC784244 OC784314 OC784315 OC784325 OC784533

glazing beads

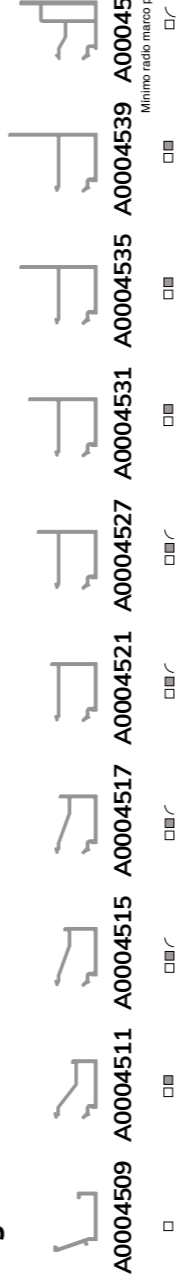

A0004509 A0004511 A0004515 A0004517 A0004521 A0004527 A0004531 A0004535 A0004539 A0004500
Mínimo radio marco puerta esp curva

Key

- WHITE STOCK
- ▣ SILVER STOCK
- ∩ SUITABLE FOR CURVE
- ⊠ TWO-COLOUR STOCK AVAILABLE
- * UNFINISHED UPON REQUEST
- ** UNFINISHED UPON REQUEST WITH MINIMUM (see number of bars).

- ▣ NB MATTE BLACK
- ∩ Unfinished available in all profiles except those marked with * or **

- ⊠ Minimum measurements for curved profiles:
- ⊙ Minimum radius of window frame AF52 / AR52 / AR62: 650
- ⊙ Minimum radius of window frame AR78+: 600 mm
- ⊙ Minimum radius of door frame for all series: 900 mm
- ⊙ Minimum radius of window frame OC78+ 750 mm

Casement series

AF52 series

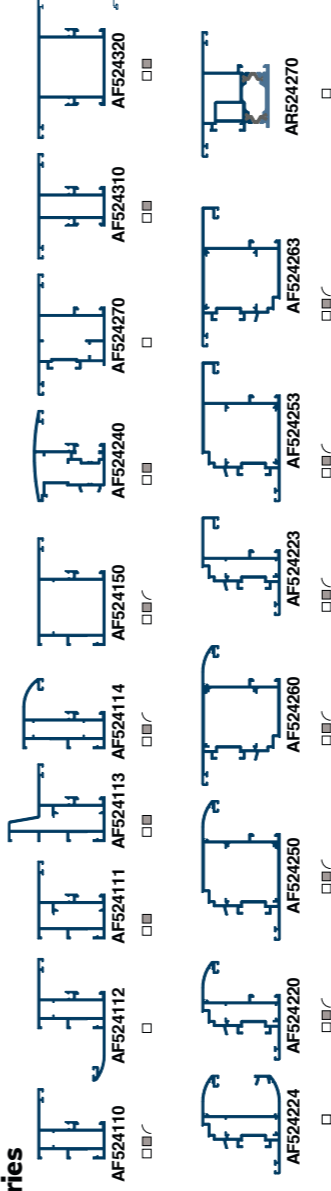

AF524110 AF524112 AF524114 AF524113 AF524114 AF524150 AF524240 AF524270 AF524310 AF524320 AF524224 AF524250 AF524260 AF524253 AF524223 AF524223 AF524222 AF524224 AF524253 AF524250 AF524260 AF524263 AF524263 AF524278 AF524310 AF524320 AF524355 AF524355 AF524354

AF35 series

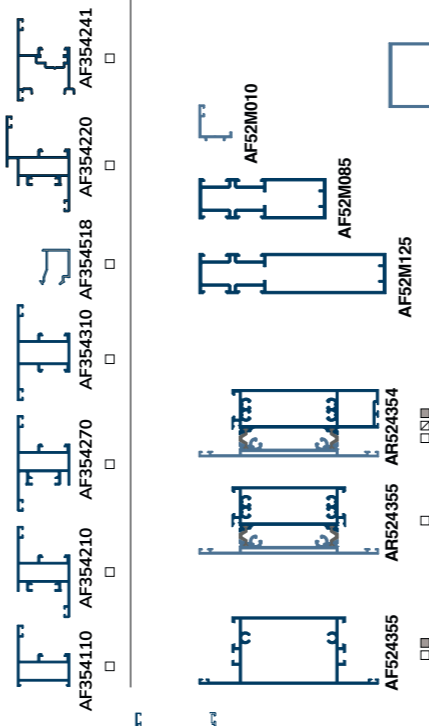

AF354110 AF354210 AF354270 AF354310 AF354518 AF354220 AF354241 AF52M010 AF52M085 AF52M125

AR52 series

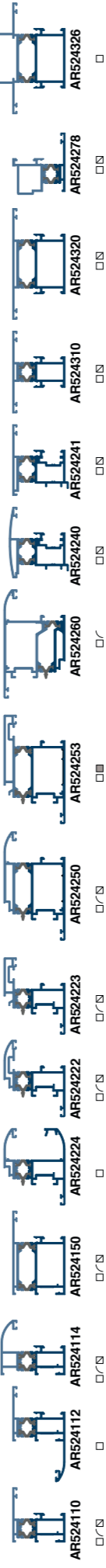

AR524110 AR524112 AR524114 AR524150 AR524224 AR524222 AR524223 AR524250 AR524253 AR524260 AR524263 AR524278 AR524310 AR524320 AR524326 AR524326 AR524278 AR524310 AR524320 AR524326

AR62 series

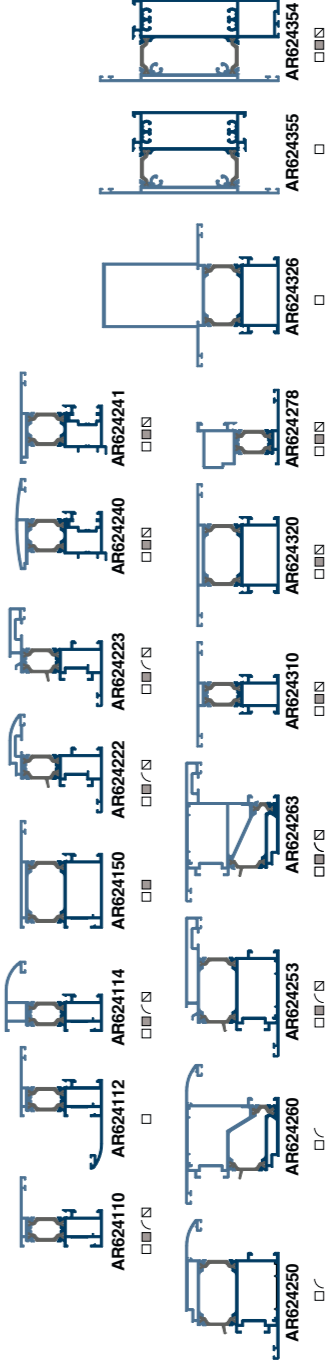

AR624110 AR624112 AR624114 AR624150 AR624222 AR624223 AR624240 AR624241 AR624250 AR624253 AR624260 AR624263 AR624310 AR624320 AR624326 AR624355 AR624354

AR78+ series

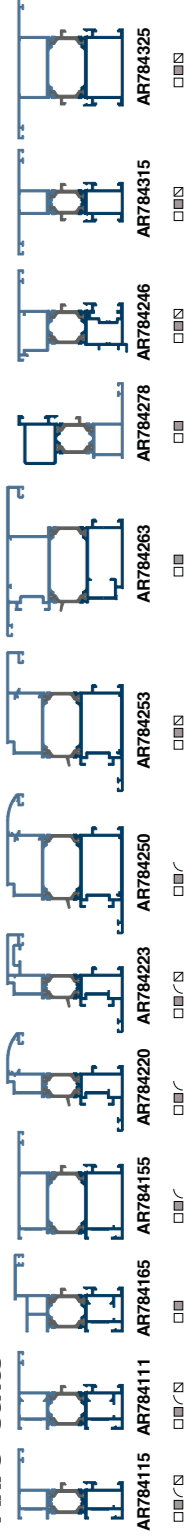

AR784111 AR784115 AR784155 AR784216 AR784223 AR784223 AR784250 AR784253 AR784263 AR784278 AR784315 AR784325

Key

- WHITE STOCK
- ▣ SILVER STOCK
- ∩ SUITABLE FOR CURVE
- ⊠ TWO-COLOUR STOCK AVAILABLE
- * UNFINISHED UPON REQUEST
- ** UNFINISHED UPON REQUEST WITH MINIMUM (see number of bars).

- ▣ NB MATTE BLACK
- ∩ Unfinished available in all profiles except those marked with * or **

- ⊠ Minimum measurements for curved profiles:
- ⊙ Minimum radius of window frame AF52 / AR52 / AR62: 650
- ⊙ Minimum radius of window frame AR78+: 600 mm
- ⊙ Minimum radius of door frame for all series: 900 mm
- ⊙ Minimum radius of window frame OC78+ 750 mm

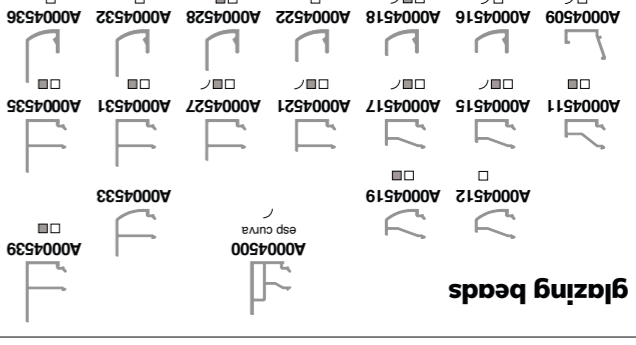

glazing beads

A0004539 A0004512 A0004519 A0004515 A0004517 A0004521 A0004527 A0004531 A0004535 A0004509 A0004516 A0004518 A0004522 A0004528 A0004532 A0004536

CF22 series

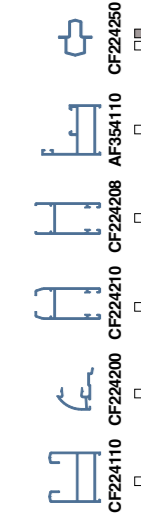

CF224110 CF224200 CF224210 CF224208 AF354110 CF224250

CF26 series

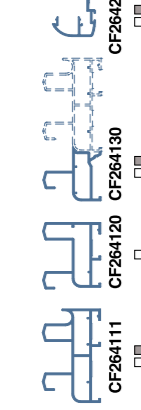

CF264111 CF264120 CF264130 CF264200 CF264210 CF264212 CF264250 A0004540 A0004560 A0004562

CF31 series

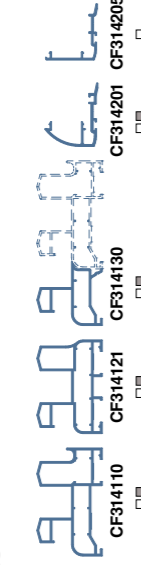

CF314110 CF314110 CF314121 CF314130 CF314201 CF314205 CF314210 CF314212 CF314250 CF314251

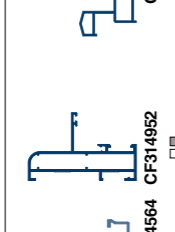

CF314140 A0004564 CF314952 CF314214 A0004564 CF314952 CF314958 CF314962

CR31 series



CR314110 CR314121 CR314130 CR314100 CR314203 CR314204 CR314211 AR004544 CR314952 CR314958

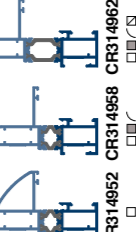

CR314211 AR004544 CR314952 CR314958 CR314962

CF40 series

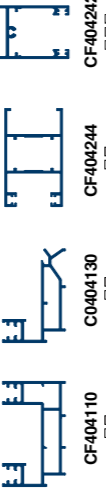

CF404110 CF404130 CF404244 CF404242 C0404201 CR404246 C0404251 CF404214 A0004040 CF404240 C0404109 CF264952

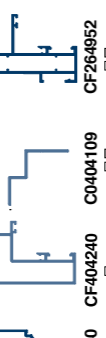

CF404109 A0004040 CF404240 C0404180 CF264952

CR40 series

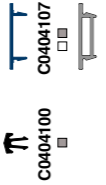

C0404100 C0404107 C0404106 C0404242 CR404242 CR404245 CR404247 CR404254 C0404182 C0404184 C0404180 AF784165

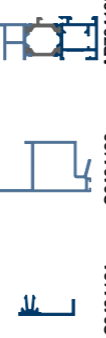

C0404180 C0404184 C0404180 AF784165

CR46 series



CR464110 CR464101 CR464130 CR464200 CR464204 CR464210 CR464508 CR464514 CR464525 CR463749 CR464109 CR464250 AR784165



CR464109 CR464250 AR784165

ER52 series



ER524110 ER524130 ER524100 ER524103 ER524120



ER524140 ER524150 ER524141 ER524250

Key
 WHITE STOCK
 SILVER STOCK
 SUITABLE FOR CURVE

TWO-COLOUR STOCK AVAILABLE
 * UNFINISHED UPON REQUEST
 ** UNFINISHED UPON REQUEST WITH MINIMUM (see number of bars).

NB MATTE BLACK
 Unfinished available in all profiles except those marked with * or **

Minimum measurements for curved profiles:
 ⊙ Minimum radius of window frame AF52 / AR52 / AR62: 650
 ⊙ Minimum radius of window frame AR78+ : 600 mm
 ⊙ Minimum radius of door frame for all series: 900 mm
 ⊙ Minimum radius of window frame OC78+ : 750 mm

Solar and sight protection and complementary profiles

Mosquito screen

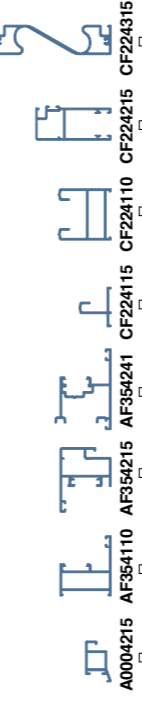

A0004215 AF354110 AF354215 AF354241 CF224115 CF224110 CF224215 CF224315

Corner units and joints



U 10x15x10 AF524279 AF354122 AR004976 AR004980

Shutters



PM404110 PM404112 PM404210 PM404220 PM404224 AF474310 PM404240 PM404101 PM404100 PM404105 PM404356 PM404358 PM404102 PM400020 PM400030 PM404560 PM400010

Blind, shutter doors and others

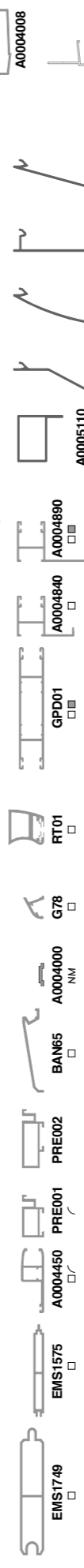

EMS1749 EMS1575 A0004450 PRE001 PRE002 BAN65 A0004000 G78 RT01 GPDD1 A0004840 A0004890 A0005110 A0005120 A0005122 A0005123 A0005123 A0004025 A0004026 A0004006 A0004007 A0004010 A0004011 A0004008 A0004009

Traditional rail

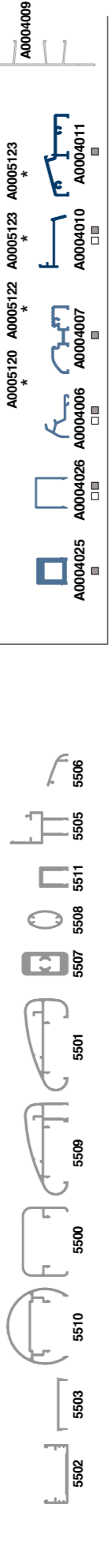

5502 5503 5510 5509 5500 5501 5507 5508 5511 5505 5506

Joint covers



A0004700 A0004736 A0004735 A0004760 A0004785 A0004780 A0004762 A0004742 A0004787 A0004780 A0004637 A0004652 A0004682

Glass rail

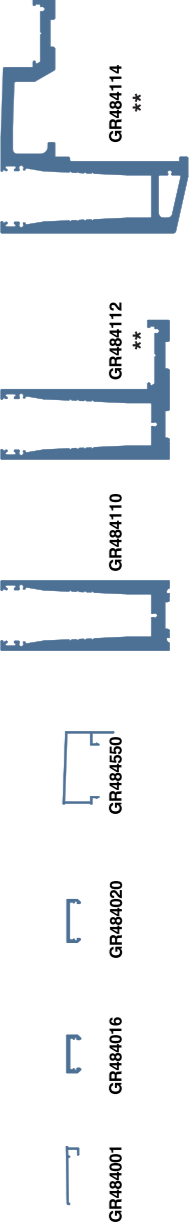

GR484001 GR484016 GR484020 GR484550 GR484110 GR484112 GR484114**

Key
 WHITE STOCK
 SILVER STOCK
 SUITABLE FOR CURVE

TWO-COLOUR STOCK AVAILABLE
 * UNFINISHED UPON REQUEST
 ** UNFINISHED UPON REQUEST WITH MINIMUM (see number of bars).

NB MATTE BLACK
 Unfinished available in all profiles except those marked with * or **

Minimum measurements for curved profiles:
 ⊙ Minimum radius of window frame AF52 / AR52 / AR62: 650
 ⊙ Minimum radius of window frame AR78+ : 600 mm
 ⊙ Minimum radius of door frame for all series: 900 mm
 ⊙ Minimum radius of window frame OC78+ : 750 mm

Design
Comfort
Silence

Technical charts of the Thermia® systems



Thermia® sliding series

Series	RPT Series	mm Frame / sash POLYAMIDE	Uw WINDOW* up to	mm MAIN FRAME	mm MAIN SASH	mm PROFILE THICKNESS	mm MAXIMUM GLASS
Thermia® ER52	Yes	24/14	1.84*	125	52	1.8	30
Thermia® CR46	Yes	24/25	1.65*	65	46	1.6 / 1.8	28
Thermia® CR40	Yes	24	1.53*	65	40	1.4 / 1.6	28
Thermia® CF40	No	No	-	65	40	1.4 / 1.6	28
Thermia® CR31	Yes	14/25	1.79*	75	31	1.5	24
Thermia® CF31	No	No	-	75	31	1.5	10 / 21
Thermia® CF26	No	No	-	65	26	1.3	10 / 17
Thermia® CF22	No	No	-	35	22	1.2	8 / 15

*Uw: According to standard EN 10077. See the details of the values in each series' specifications sheet.

SERIES	MAXIMUM GLASS WEIGHT (kg)	3 TRACK OPTION	4 OR MORE TRACKS	AVAILABLE PROFILES	COLORS IN STOCK
Thermia® ER52	350	Yes	No	Window / Balcony Door	Raw
Thermia® CR46	180	Yes	Yes	Window / Balcony Door	Raw / Silver / White
Thermia® CR40	160 / 200 kg	Yes	Yes	Window / Balcony Door	Raw / Silver / White
Thermia® CF40	160 / 200 kg	Yes	Yes	Window / Balcony Door	Raw / Silver / White
Thermia® CR31	160	Yes	Yes	Window / Balcony Door	Raw / Silver / White
Thermia® CF31	160	Yes	Yes	Window / Balcony Door	Raw / Silver / White
Thermia® CF26	120	Yes	Yes	Window / Balcony Door	Raw / Silver / White
Thermia® CF22	80	No	No	Window	Raw / White

Windows for a better life



Thermia® casement series

SERIES	RPT Series	mm POLYAMIDE Frame / sash	Uw WINDOW* up to	mm MAIN FRAME	mm MAIN SASH	mm PROFILE THICKNESS
Thermia® AF52 C16	No	No	-	45	52	1.5-1.8
Thermia® AR78+ C16	Yes	24	1.17*	70	78	1.5-1.8
Thermia® OC78+ C16	Yes	24	1.47*	70	66	1.5
Thermia® AR78+ CE	Yes	24	1.07*	70	78	1.5-1.8
Thermia® AR62 CE	Yes	24	1.46*	55	62	1.5-1.8
Thermia® AR5 CE	Yes	14	1.56*	45	52	1.5-1.8
Thermia® AF52 CE	No	No	-	45	52	1.5-1.8
Thermia® AF35	No	No	-	35	35	1.2

*Uw: According to standard EN 10077. See the details of the values in each series' specifications sheet.

SERIES	MAXIMUM GLASS (mm)	MAXIMUM GLASS WEIGHT WITH CASEMENT GLASS SYSTEM (kg)	MAXIMUM GLASS WEIGHT WITH TILT AND TURN SYSTEM (kg)	AVAILABLE PROFILES	COLORS IN STOCK
Thermia® AF52 C16	27	80	100	Window	Raw / Silver / White
Thermia® AR78+ C16	49	80	100	Window / Door	Raw / Silver / White
Thermia® OC78+ C16	28	90	100 (C16)	Window	Raw / Silver / White
Thermia® AR78+ CE	49	90 (CE)	130 (CE) 100 (C16)	Window / Door	Raw / Silver / White
Thermia® AR62 CE	37	90	130	Window / Door	Raw / Silver / White
Thermia® AR52 CE	27	90	130	Window / Door	Raw / White
Thermia® AF52 CE	27	90 (CE)	130 (CE) 100 (C16)	Window / Door	Raw / Silver / White
Thermia® AF35	8 / 21	90	130	Window	Raw / White

Design
Comfort
Silence

Acoustic properties of glazed windows

Simplified calculation according to standard EN-UNE 14351-1:2006

Valid according to the Technical Building Code Catalog of Construction Components

Annotations:

- C Spectral adaptation term of the sound reduction index for incident pink noise, in dB.
 C_{tr} Spectral adaptation term of the sound reduction index for automobile noise, in dB.
 RA Global sound reduction index, A weighted, in dBA.
 RA_{tr} Global sound reduction index, A weighted, for automobile noise, in dBA.
 R_w Global sound reduction index, in dB.

ACOUSTIC INSULATION VALUES FOR WINDOWS with a surface area of up to 2.7 m ²												
Composition		THERMIA® Series										
		CF31 / CF40 / CR31 / CR40 / CR46 / ER52					AF52 / AR52 / AR62 / AR78+					
Type	Thickness (mm)	R _w (dB)	C (dB)	C _{tr} (dB)	RA (dBA)	RA _{tr} (dBA)	R _w (dB)	C (dB)	C _{tr} (dB)	RA (dBA)	RA _{tr} (dBA)	
Plain glass	6	28	-1	-1	27	27	31	-2	-3	29	28	
	8	29	-1	-2	28	27	32	-2	-3	30	29	
	10	29	-1	-2	28	27	33	-2	-3	31	30	
	12	29	-1	-1	28	28	34	0	-2	34	32	
Laminated glass (0.36 butyral)	3+3											
	4+4											
	6+6	29	-1	-2	28	27	32	-1	-3	31	29	
	8+8	29	-1	-2	28	27	33	-1	-3	32	30	
	10+10	29	-1	-2	28	27	34	-1	-3	33	31	
Insulated glass units (air chamber measuring 6 mm to 20 mm)	4/(6..20)/4	27	-1	-2	26	25	32	-1	-5	31	27	
	4/(6..20)/6	29	-1	-2	28	27	34	-1	-4	33	30	
	4/(6..20)/8	29	-1	-2	28	27	34	-1	-4	33	30	
	4/(6..20)/10	29	-1	-2	28	27	35	-1	-4	34	31	
	6/(6..20)/6	28	-1	-2	27	26	33	-1	-4	32	29	
	6/(6..20)/8	29	-1	-2	28	27	35	-1	-5	34	30	
	6/(6..20)/10	29	-1	-1	28	28	35	-1	-3	34	32	
Insulated glass with laminated panes	6/(6..20)/6+6	29	-1	-2	28	27	34	-1	-4	33	30	
	6/(6..20)/10+10	-	-	-	-	-	36	-1	-4	35	32	

Correction by side:	Total surface area of the windows	Correction factor to be applied to RA and RA _{tr}
	2.7 m ² < A ≤ 3.6 m ²	-1 dB
	3.6 m ² < A ≤ 4.6 m ²	-2 dB
	4.6 m ² < A	-3 dB

International Distribution

Latin America

- Peru
- Ecuador
- Chile
- Colombia
- El Salvador
- Panama
- Honduras
- Costa Rica
- Dominican Republic

Europe

- Spain
- France

Africa

- Algeria

Asia

- India

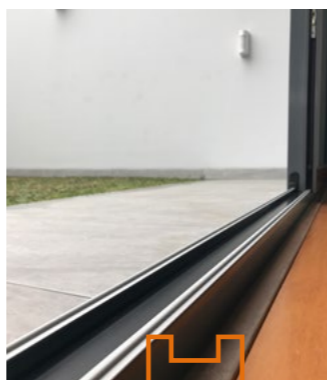
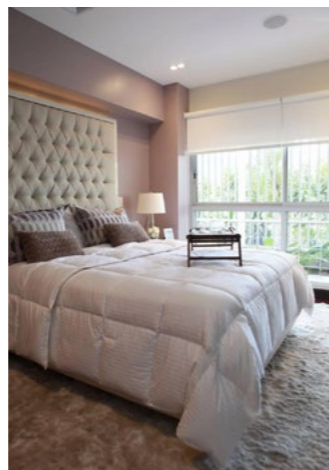
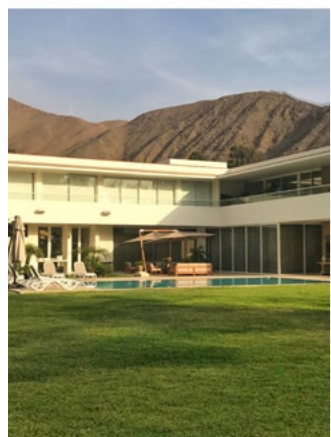
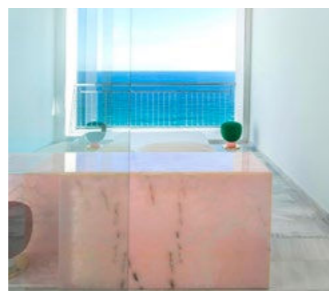

Windows for a **better life**



THE[®]RMIA

B A R C E L O N A

THE

**Design.
Comfort.
Silence.**

Andean Area Delegation

Calle Tejedores, 170 | Urb ind vulcano.
Ate - Lima | Tel. +51 17197649

Headquarters in Barcelona

C/ Narcís Monturiol, 34
08192 Sant Quirze del Vallès
Barcelona (Spain).
export@thermiabarcelona.com
Follow us at   

THERMIABARCELONA.COM