

SISTEMA PRACTICABLE

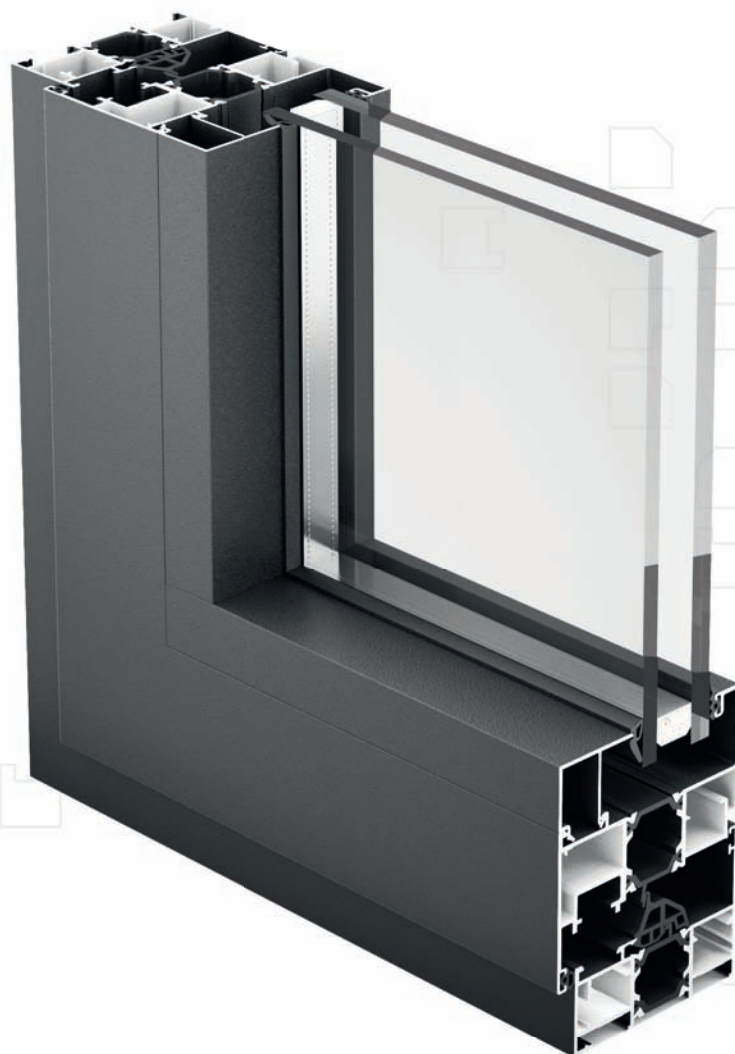

THERMIA® AR78+
La solución para los más exigentes.

THERMIA®
BARCELONA

Ventanas para vivir mejor

PERMEABILIDAD AL AIRE según EN 12207 - Marcado CE según EN 14351-1:2006 (E.1)

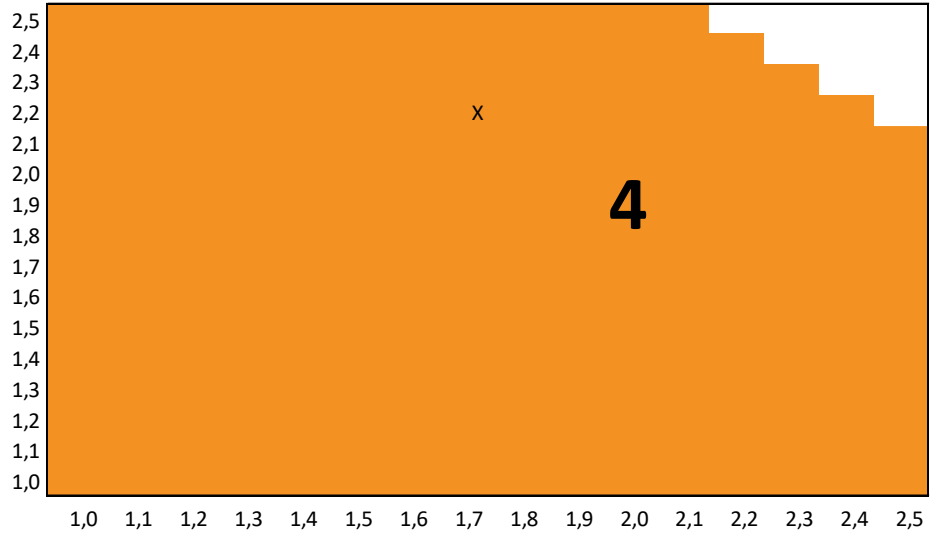

ESTANQUIDAD AL AGUA según EN 12208 - Marcado CE según EN 14351-1:2006 (E.1)

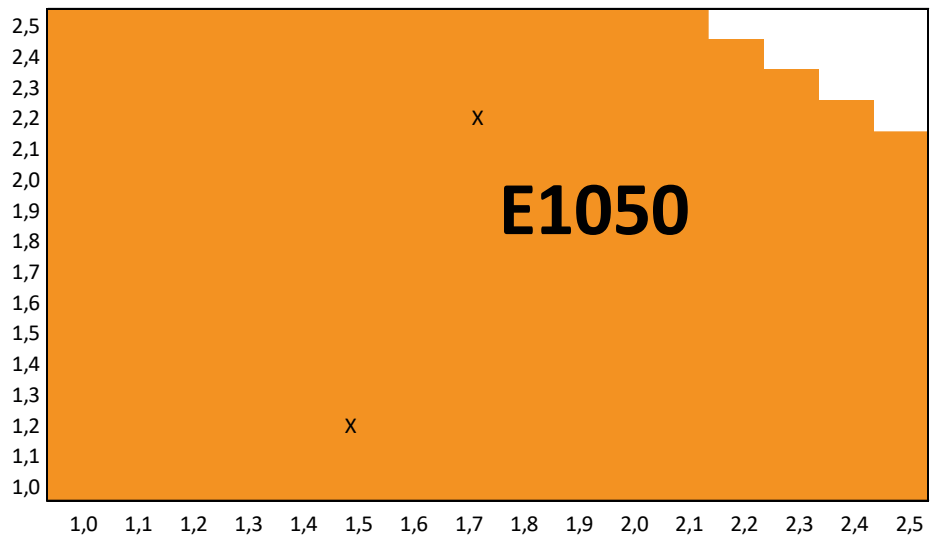

RESISTENCIA AL VIENTO según EN 12210 - Marcado CE según EN 14351-1:2006 (E.1)

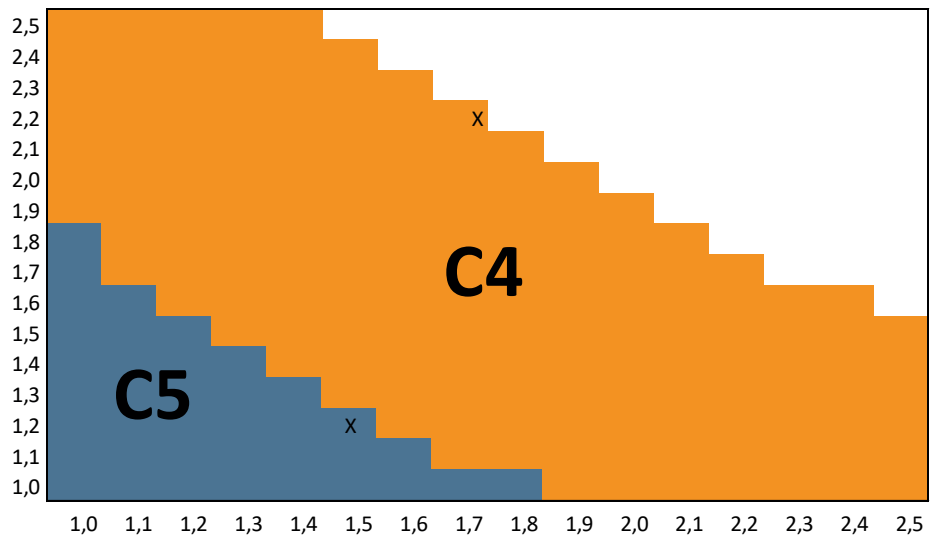

Resultados obtenidos de los informes según ensayos realizados en Applus, y en base al Anexo E de la norma EN 14351-1:2006.

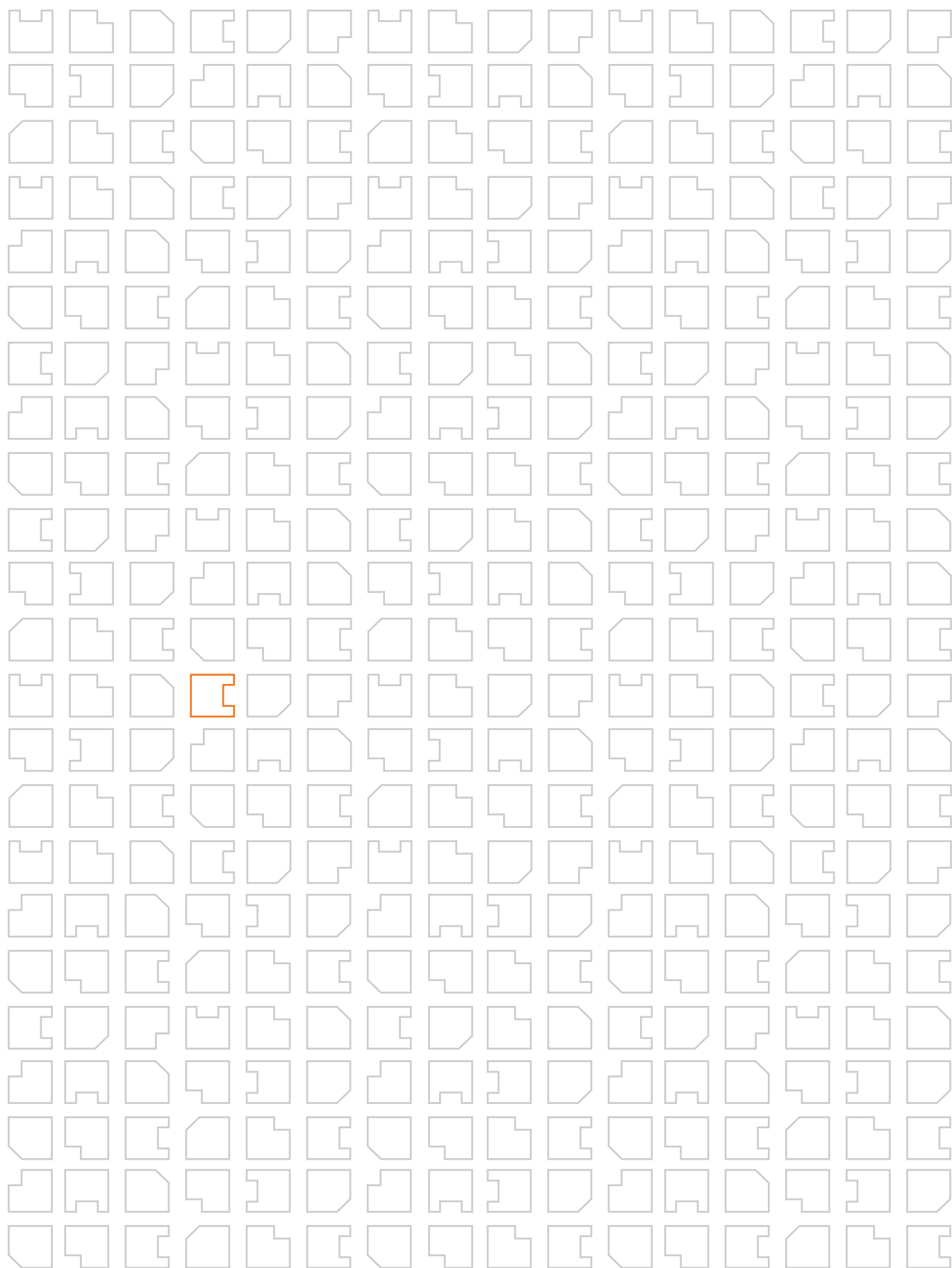

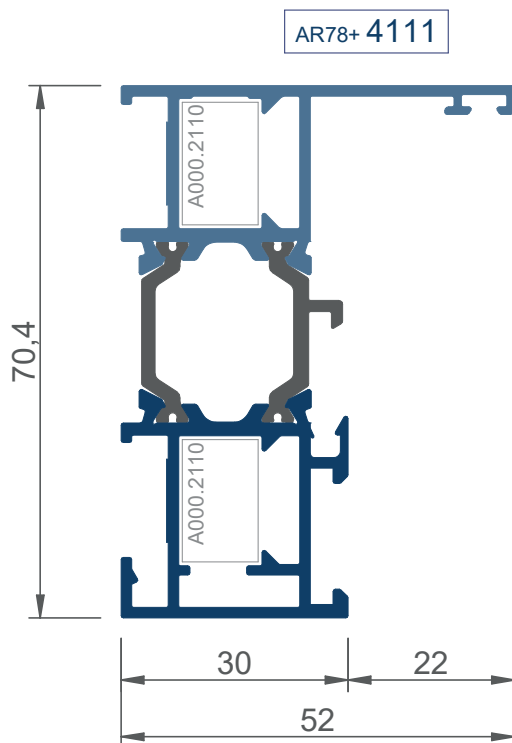
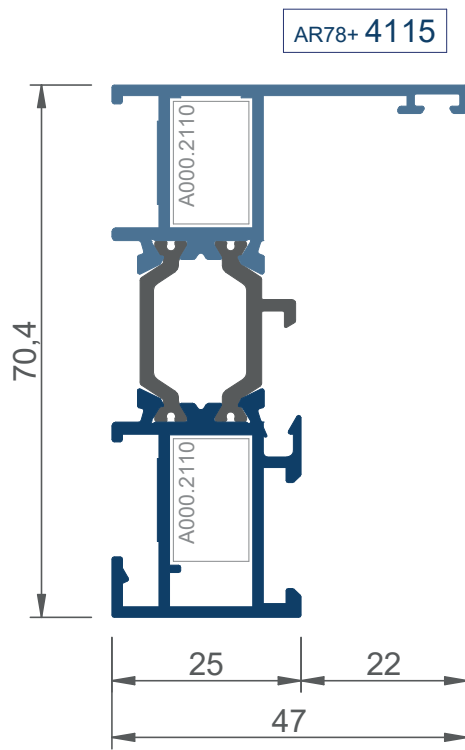

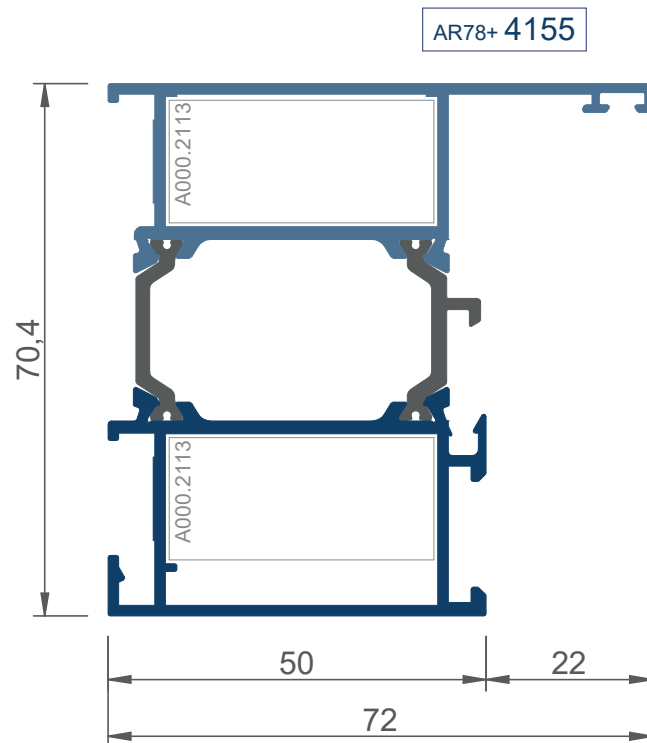
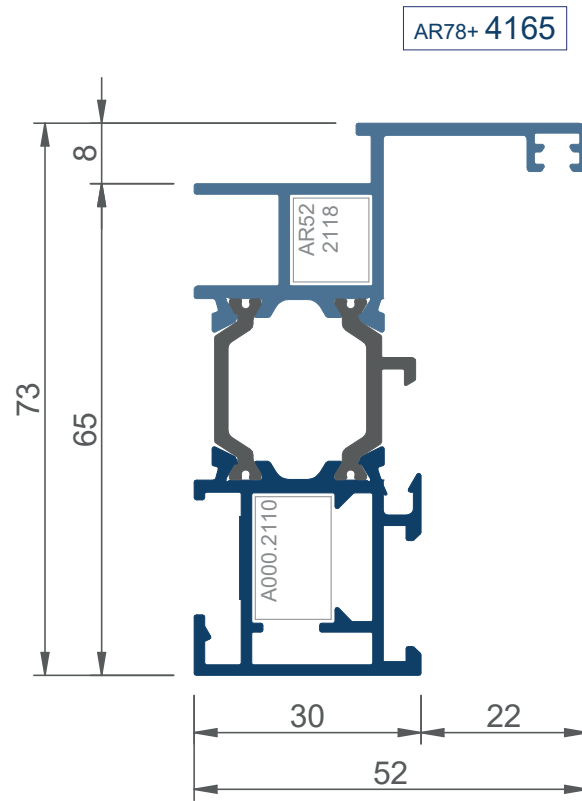

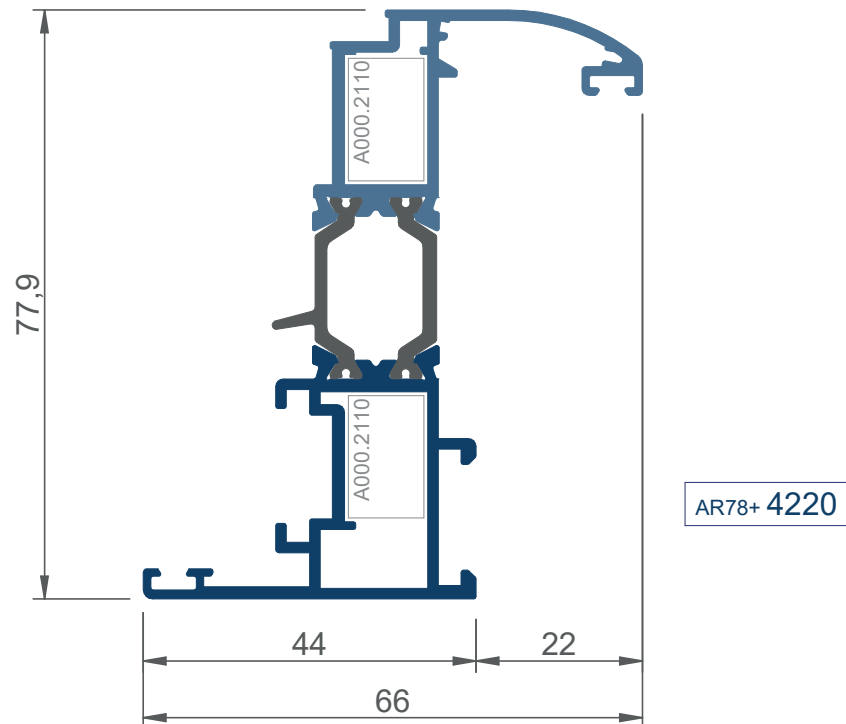
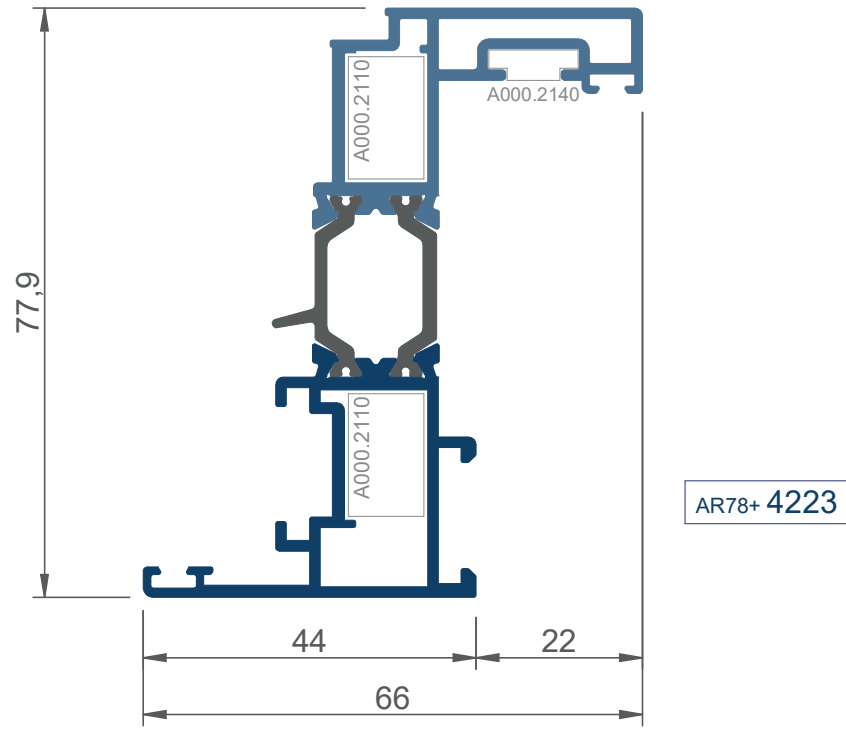

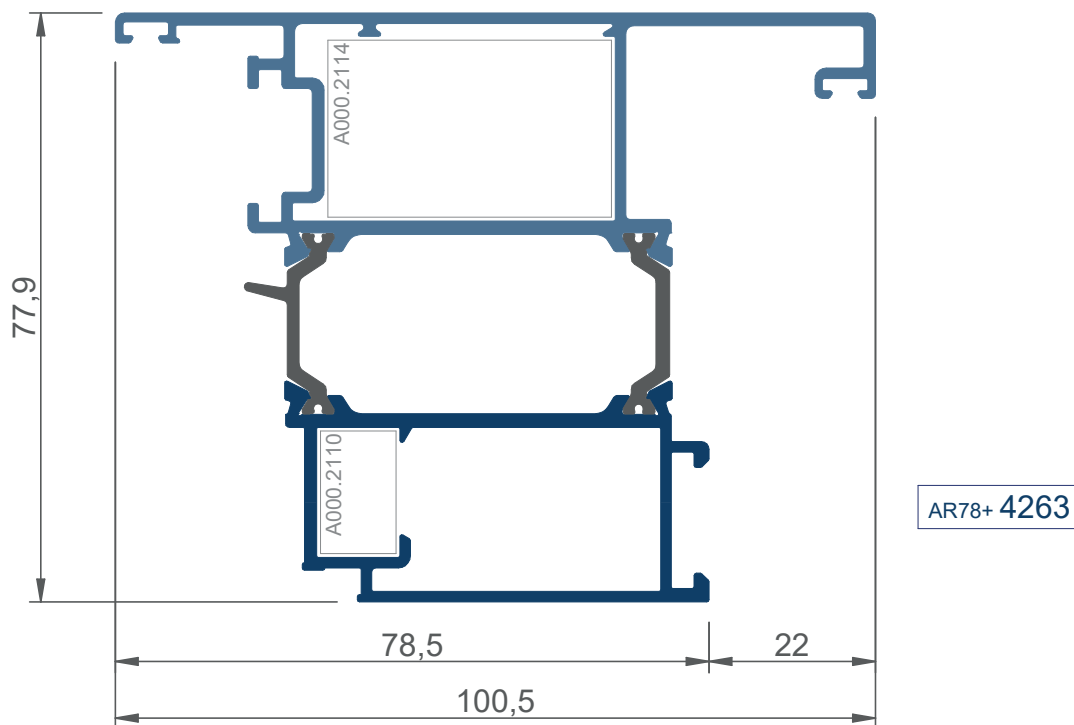
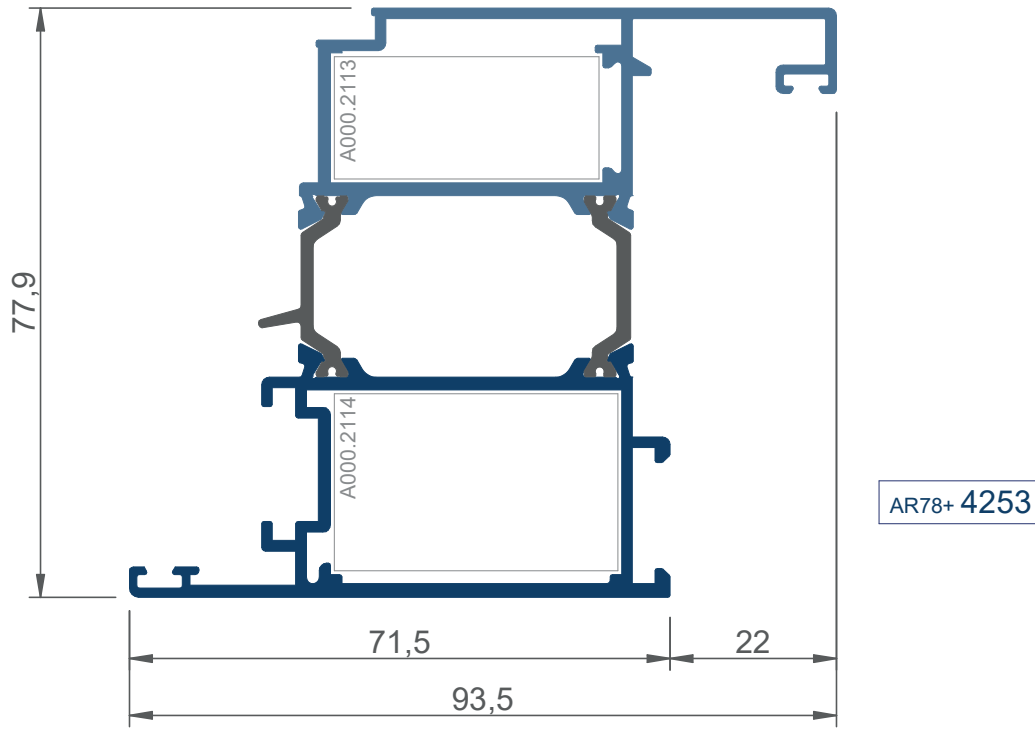

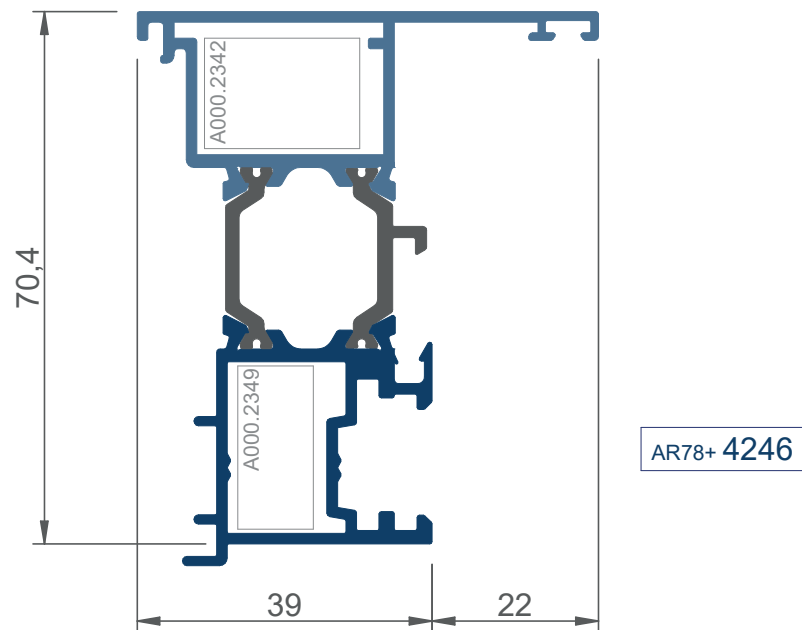
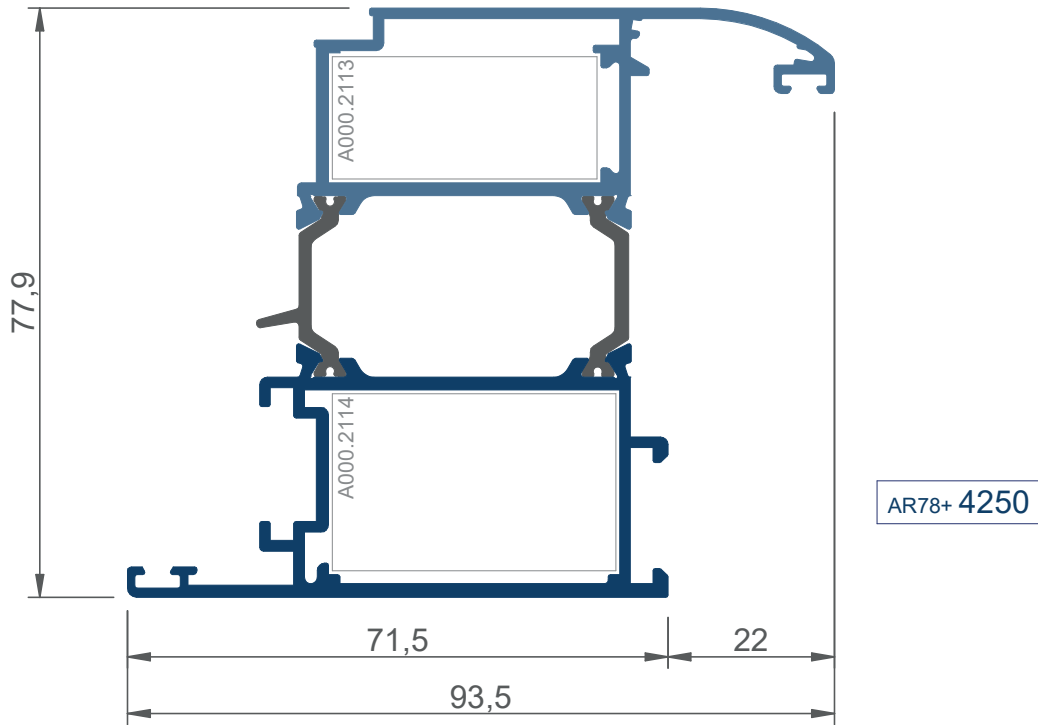

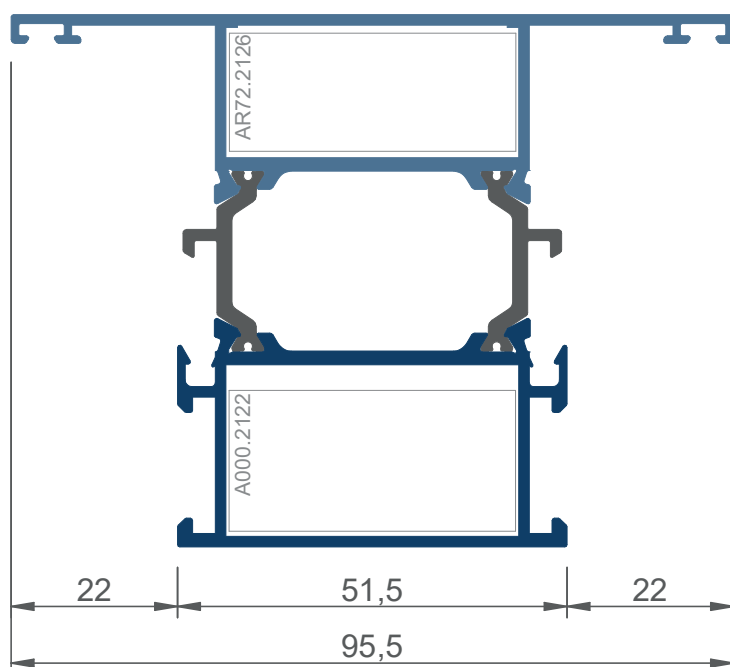
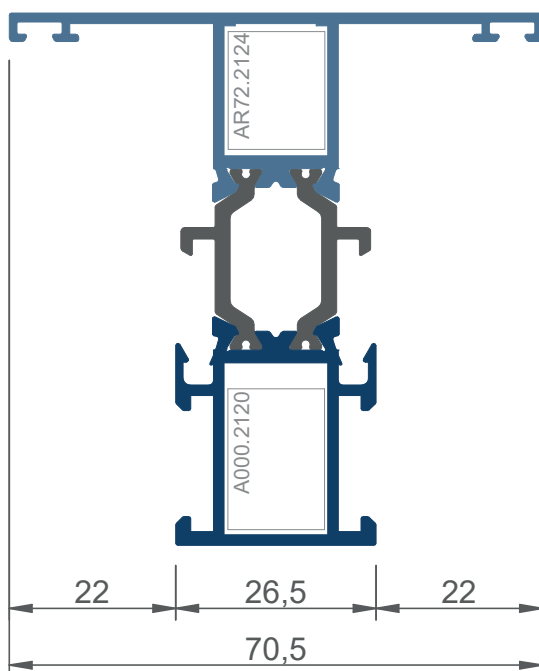

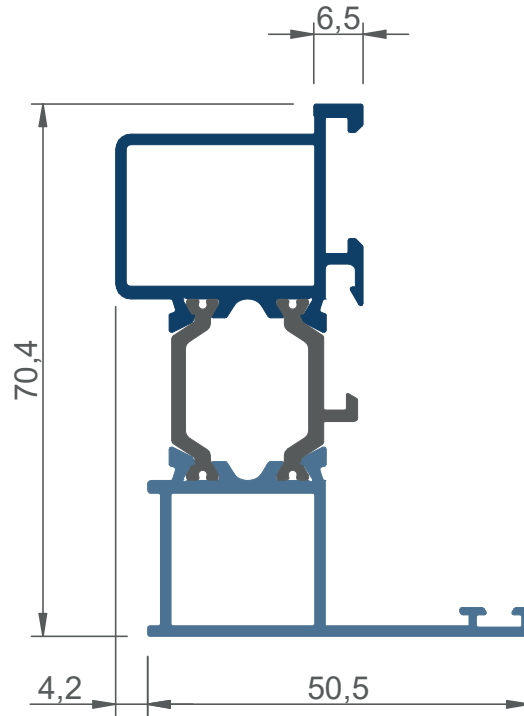

AR78+ 4278

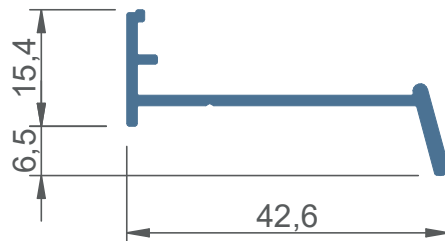

A000 4010

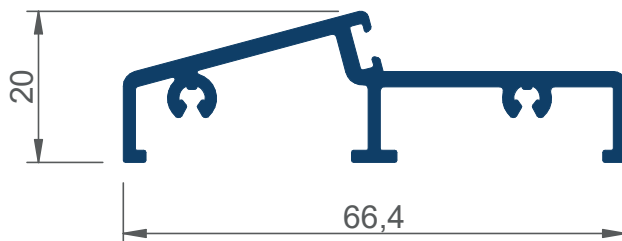

A000 4011

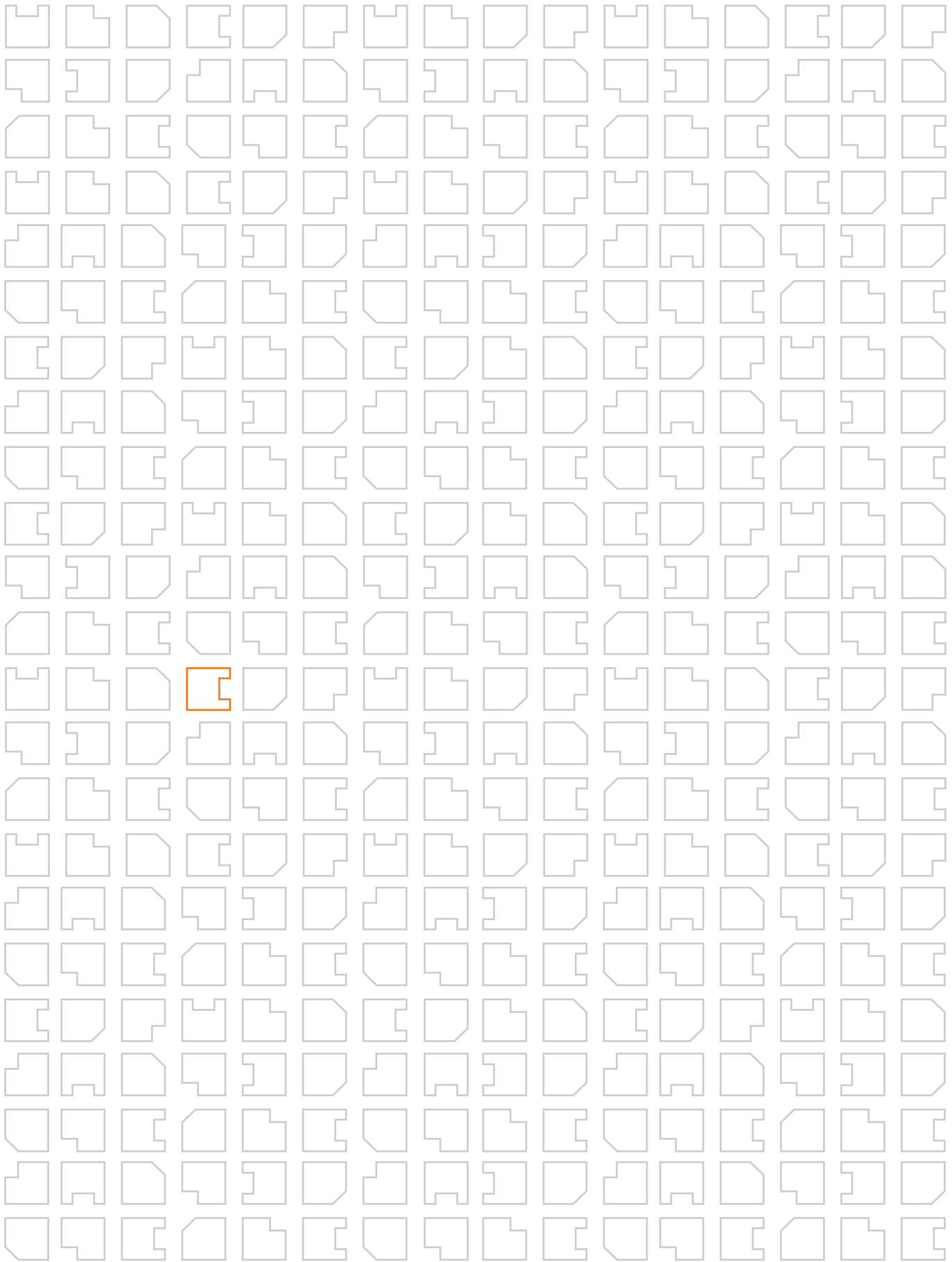

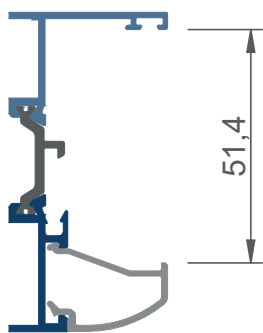

A000 4512

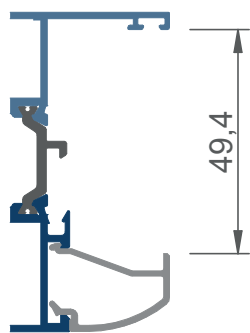

A000 4519

grapa junquillos elípticos

A000 2102

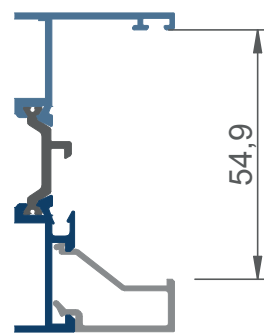
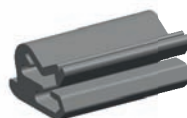

A000 4511

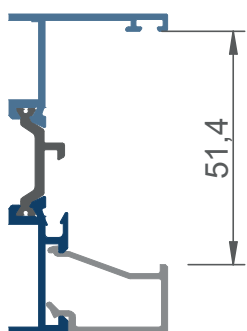

A000 4515

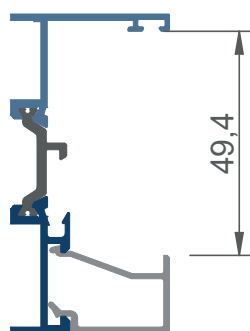

A000 4517

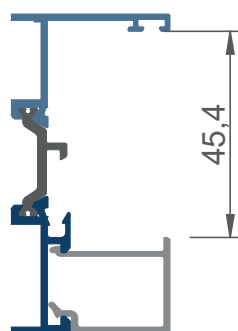

A000 4521

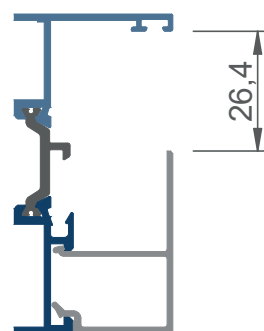

A000 4539

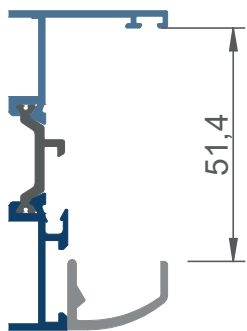

A000 4516

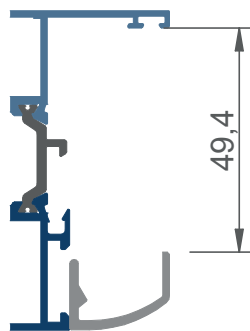

A000 4518

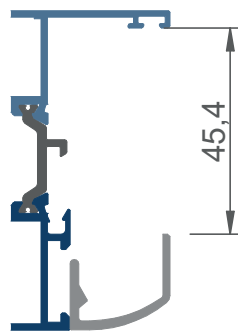

A000 4522



A000 2351

junta exterior (2mm)



A000 2353

junta cuña (de 3 a 5mm)



A000 2355

junta cuña (de 5 a 7mm)



A000 2357

junta cuña (de 7 a 9mm)

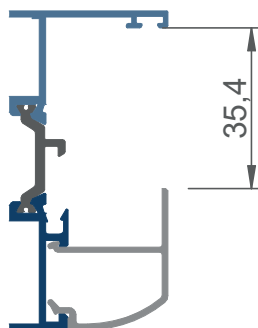

A000 4533

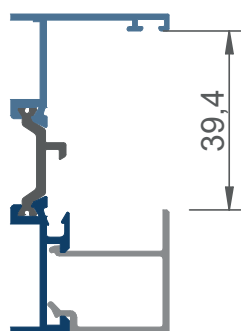

A000 4527

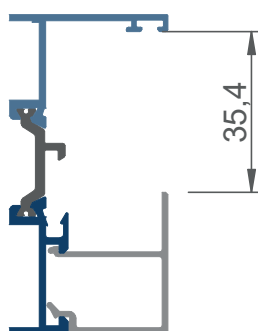

A000 4531

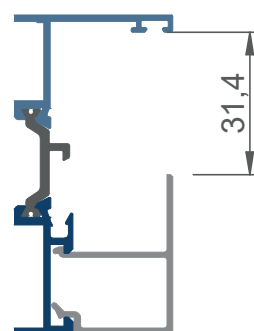

A000 4535

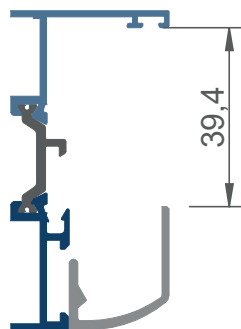

A000 4528

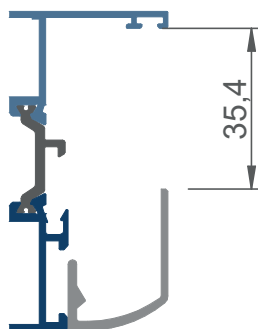

A000 4532

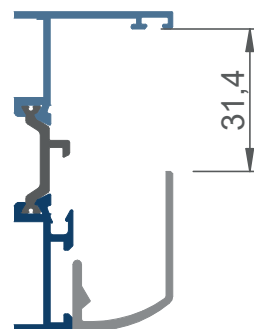

A000 4536

escuadra alineación alas exteriores

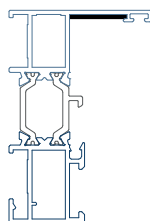

escuadra alineación ala cremona

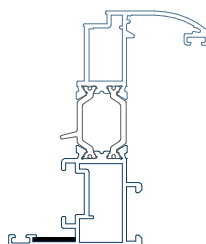

escuadra alineación multiuso

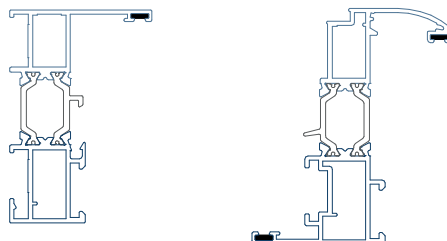

escuadra alineación multiuso
(alojamiento juntas)



colocación posible
con la junta

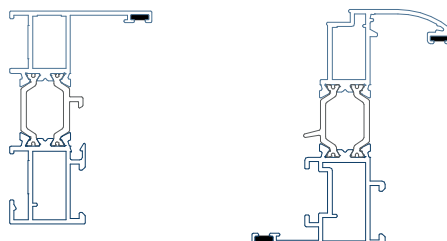

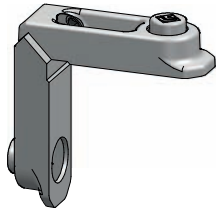

A000 2110
escuadra base

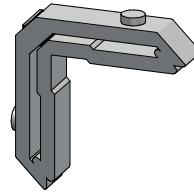

AR52 2118
escuadra exterior

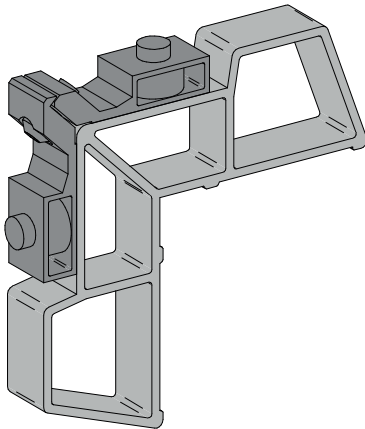

A000 2113
escuadra hoja p.

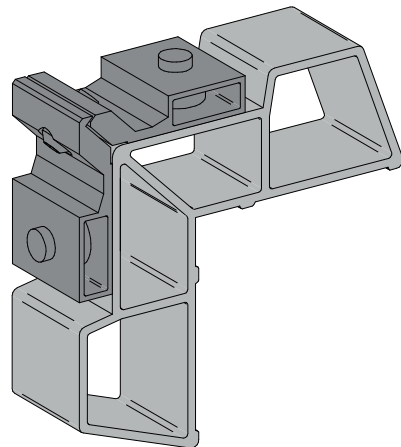

A000 2114
escuadra hoja p.

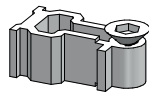

A000 2120
unión travesaño

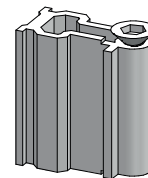

A000 2122
unión montante

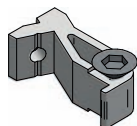

AR72 2124
unión complementaria P

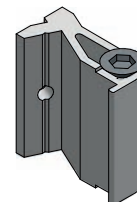

AR72 2126
unión complementaria G

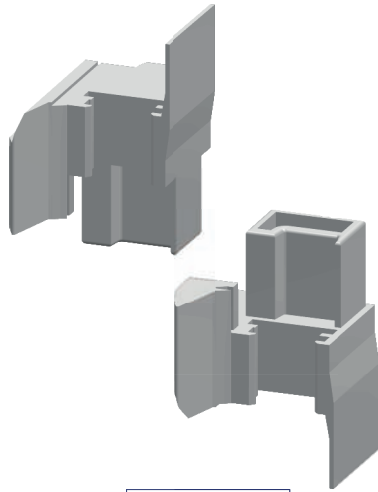

A000 2349

juego base tapas inv CE junta +

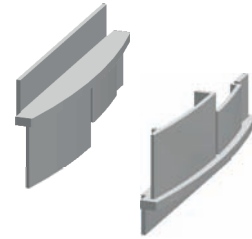

A000 2341

juegos tapas ext inv curvo

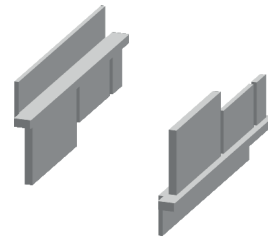

A000 2342

juego tapas ext inv recto

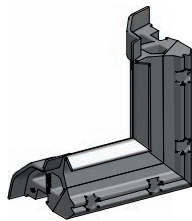

A000 2307

ángulo junta central series +



A000 2308

junta central series +

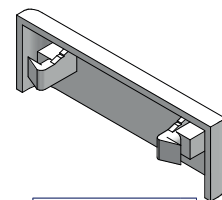

A000 2301

tapón deflector



A000 2320

junta int hoja



A000 2961

tapa intermedio perf. inv.

Para accesorios de Maniobra consultar catálogo específico

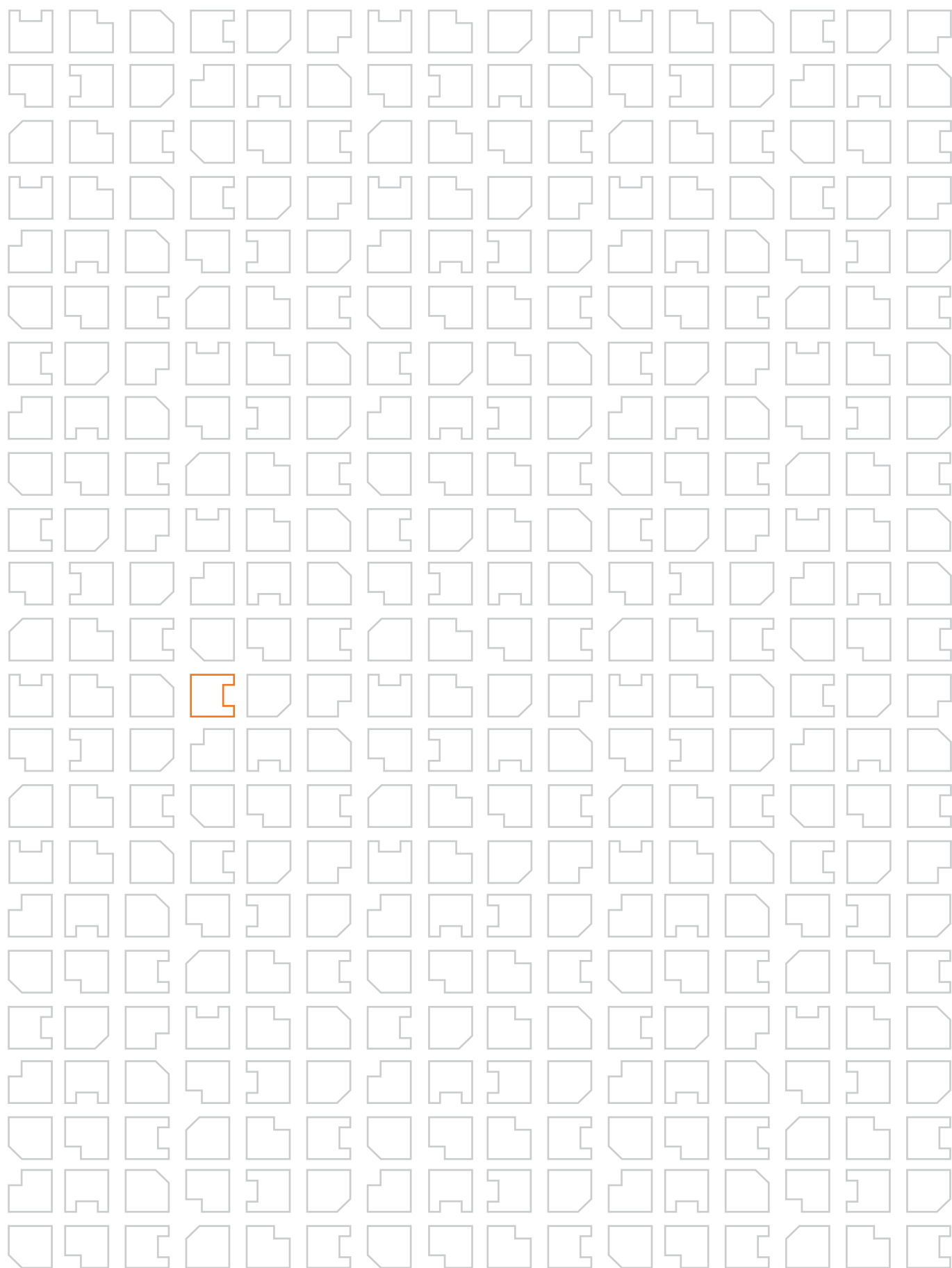

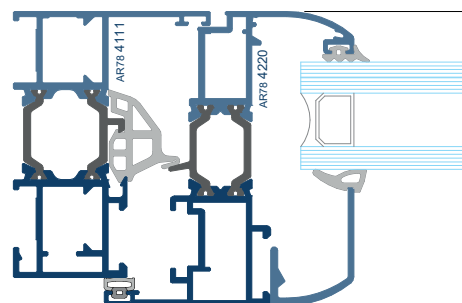
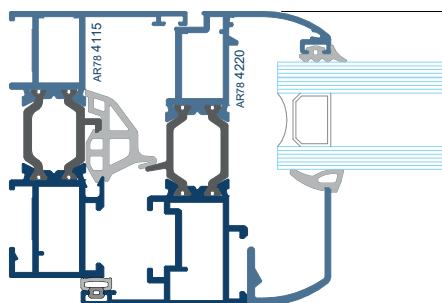
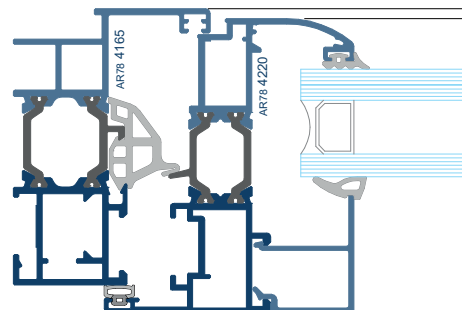
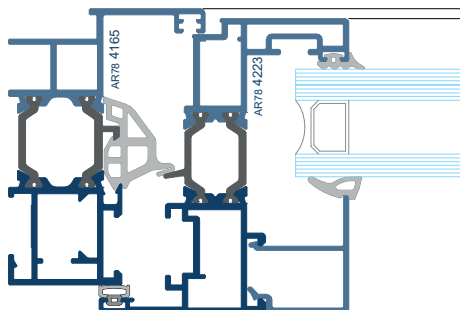
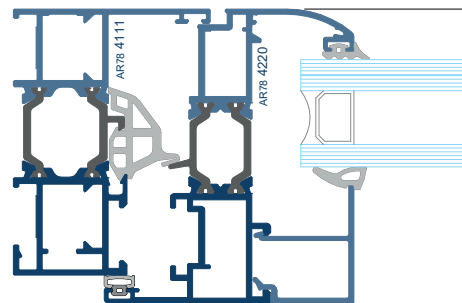
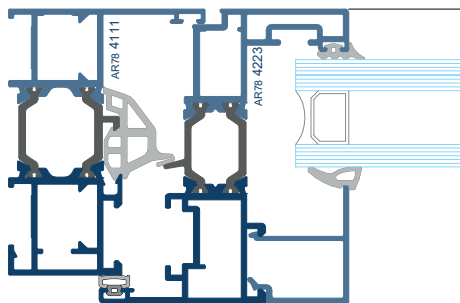
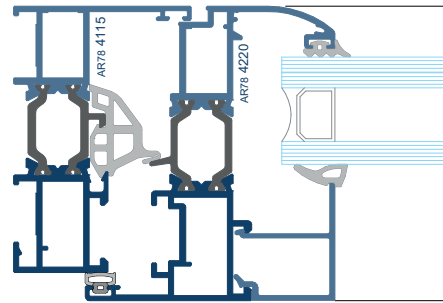
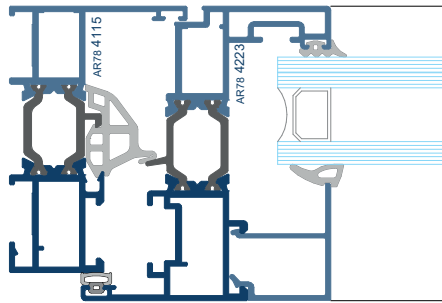

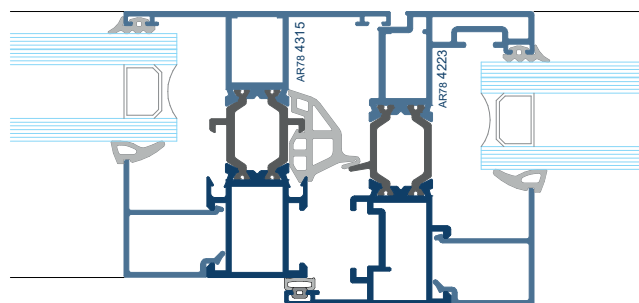
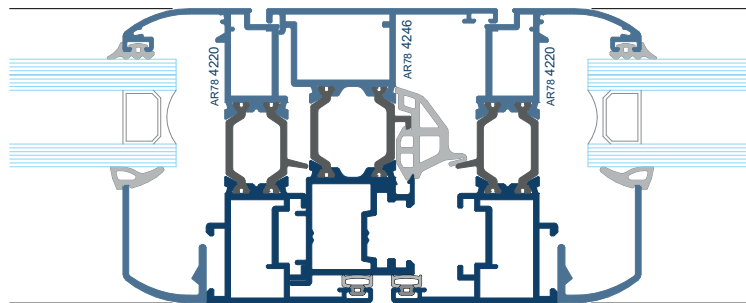
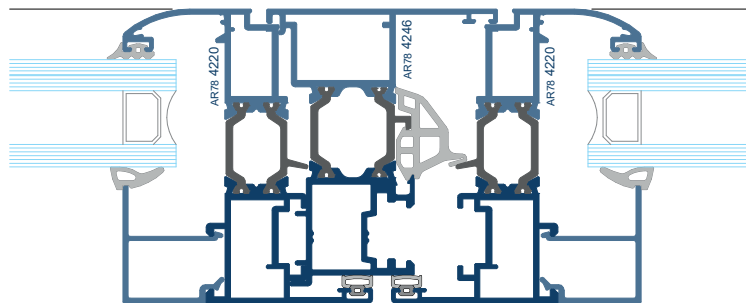
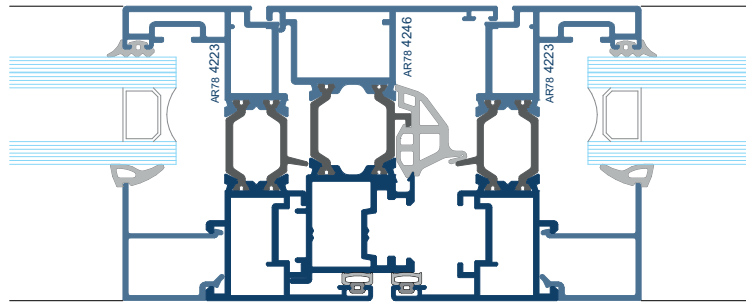

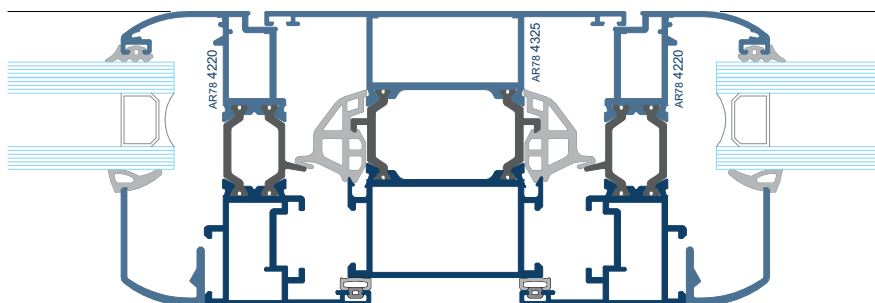
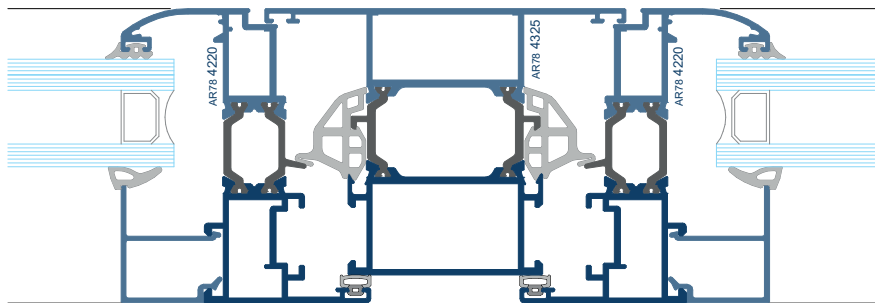
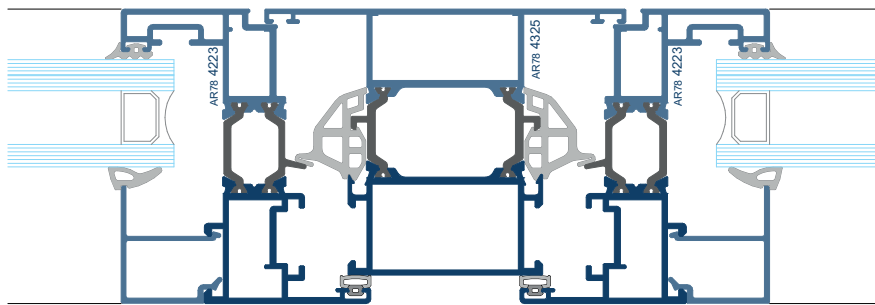
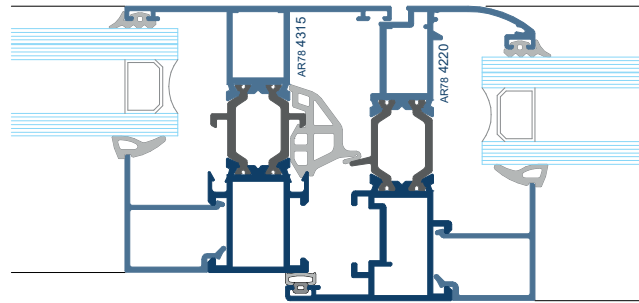

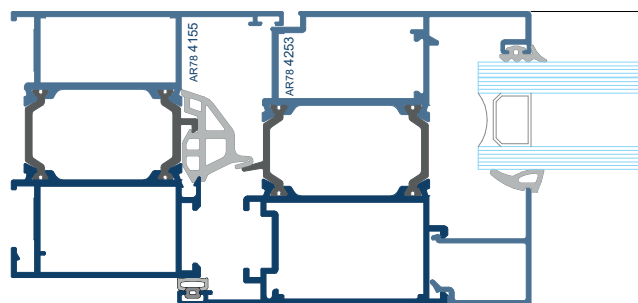
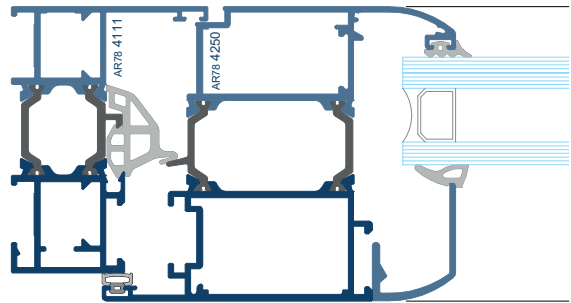
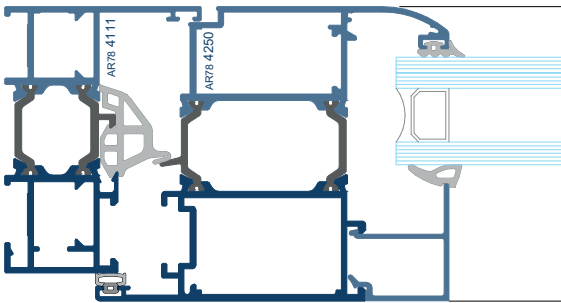
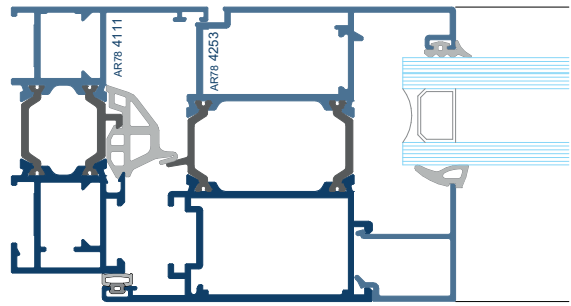
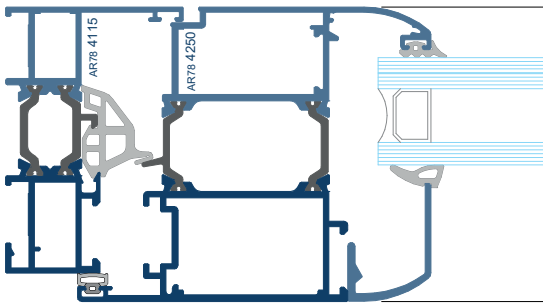
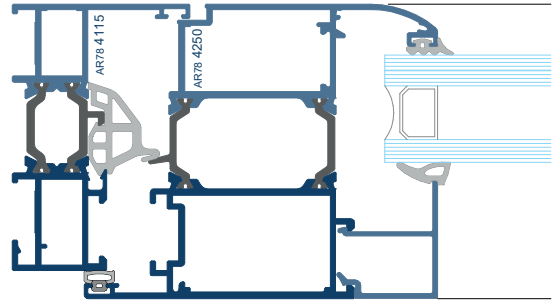
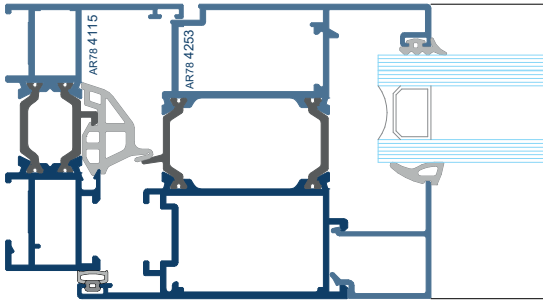

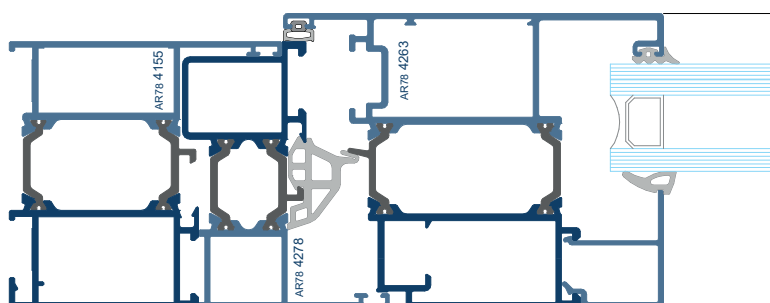
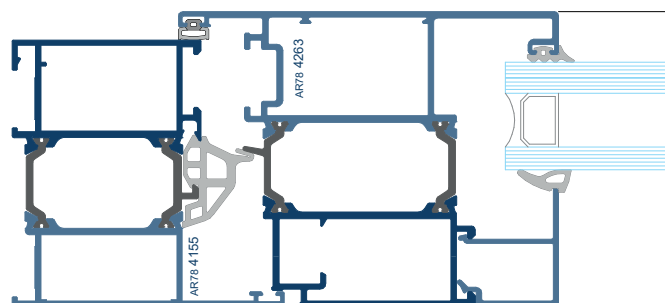
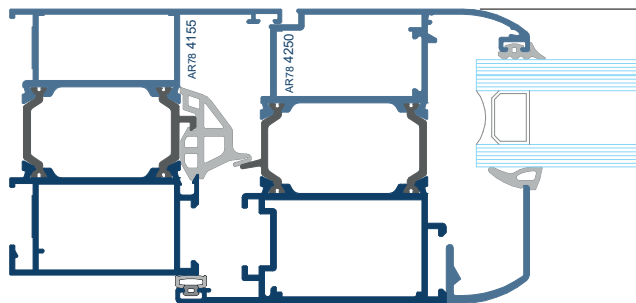
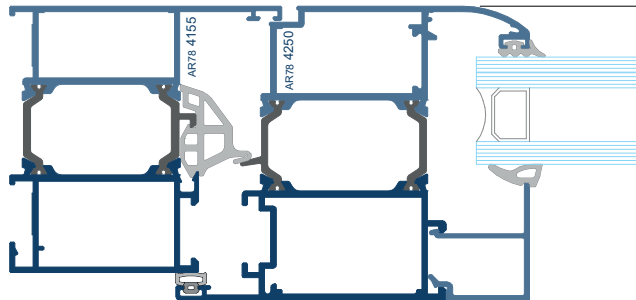

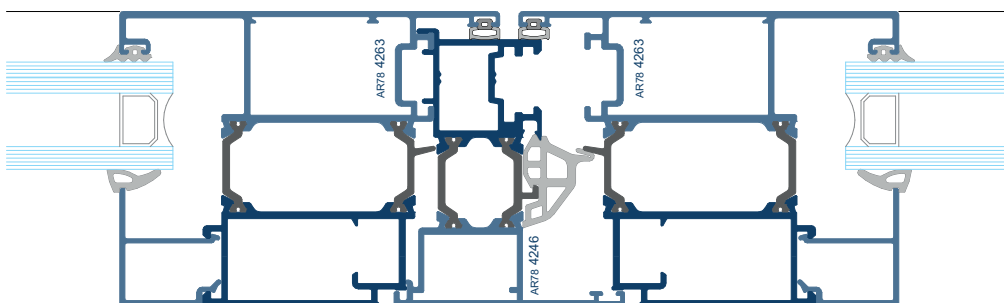
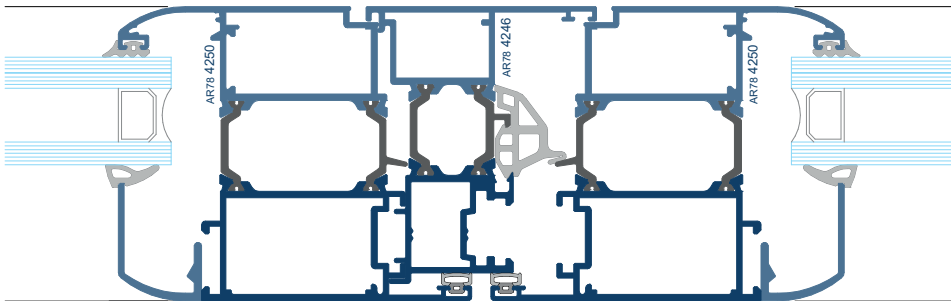
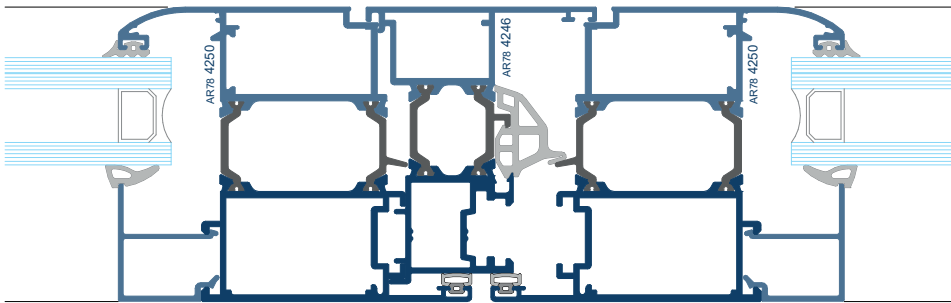
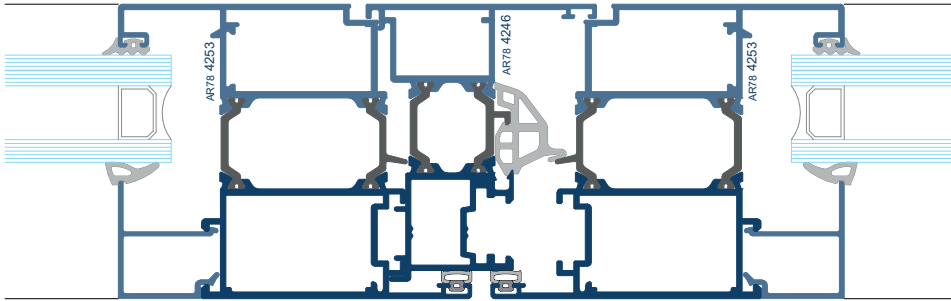

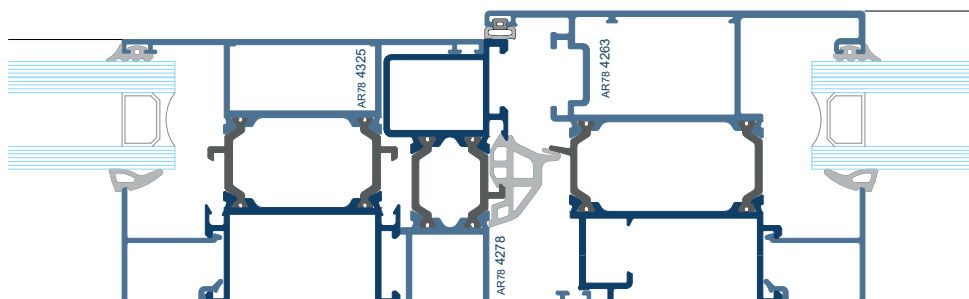
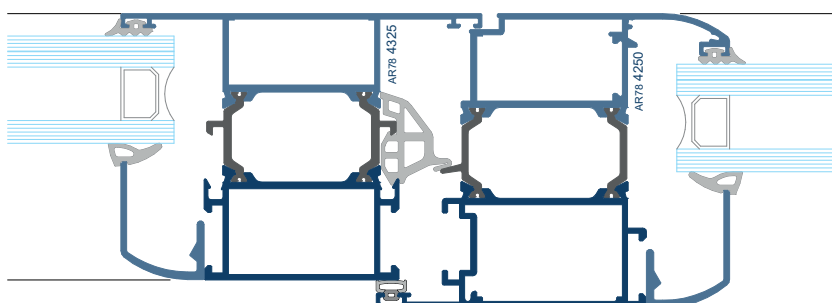
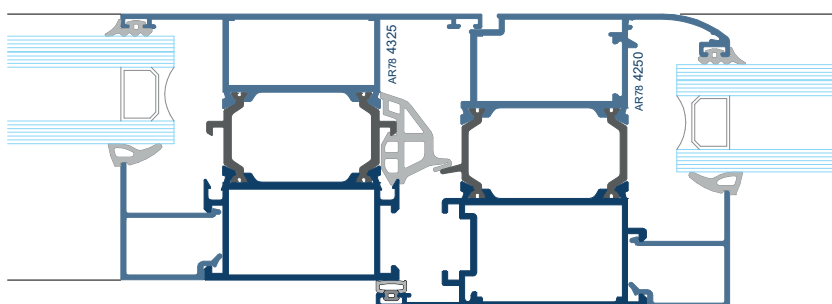
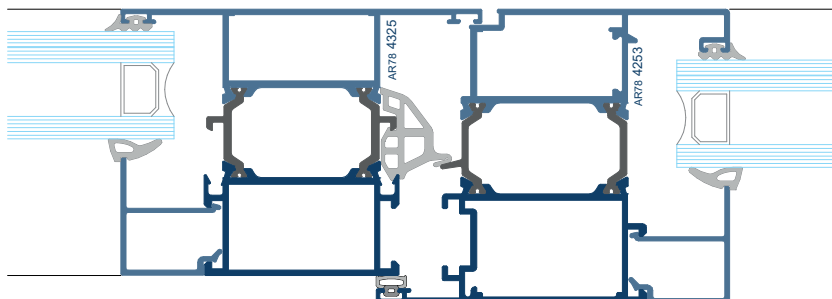

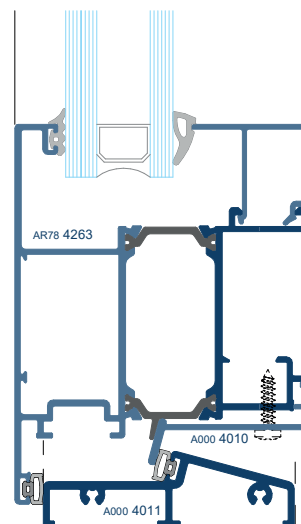
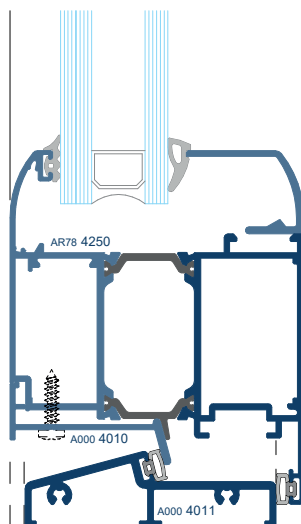
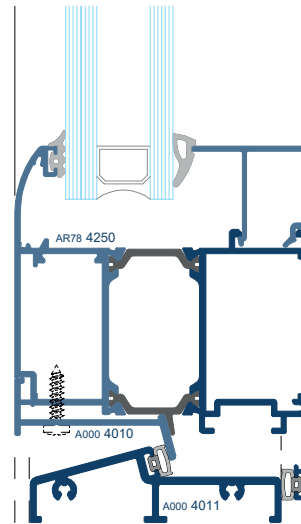
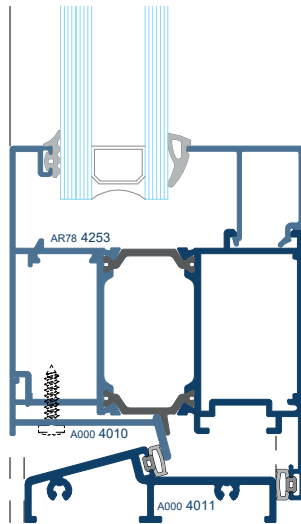

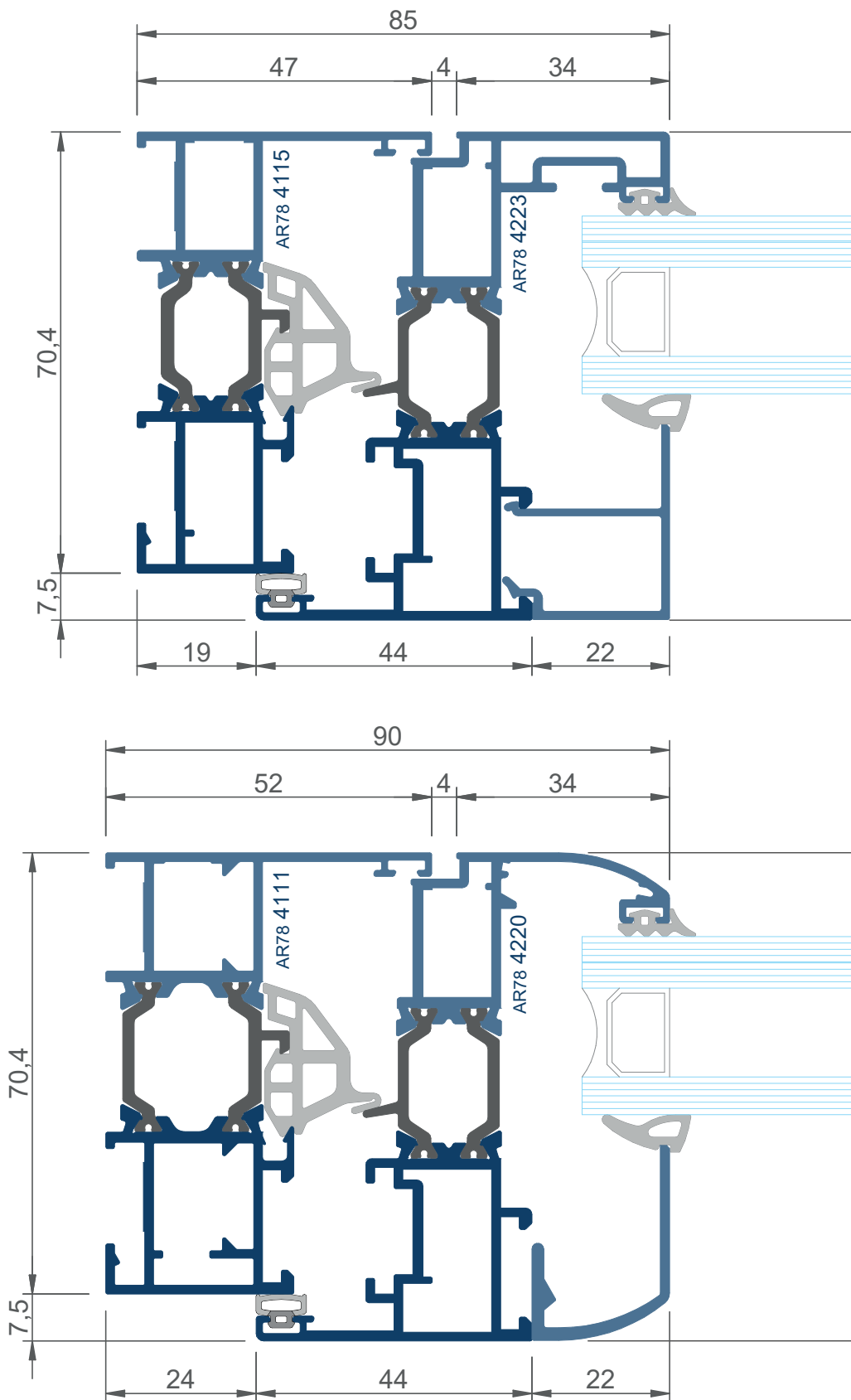

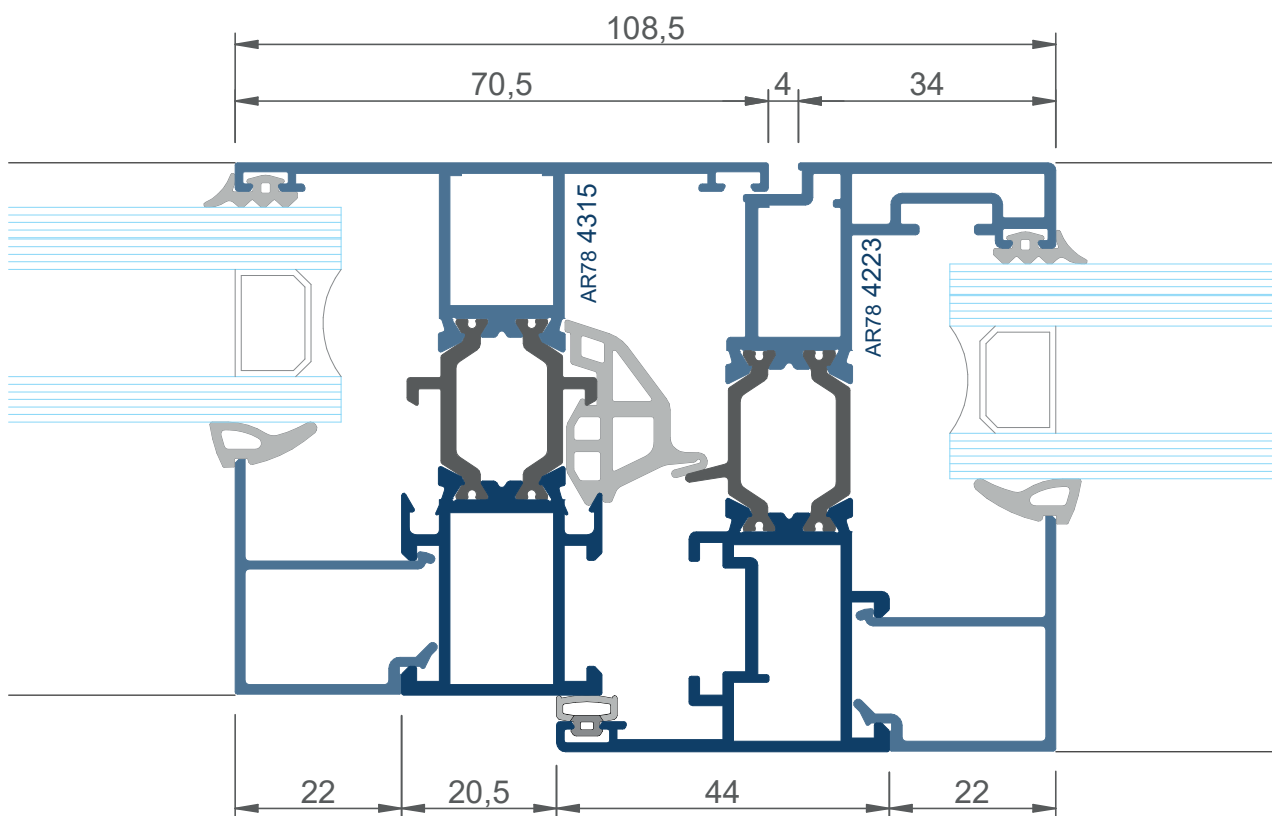
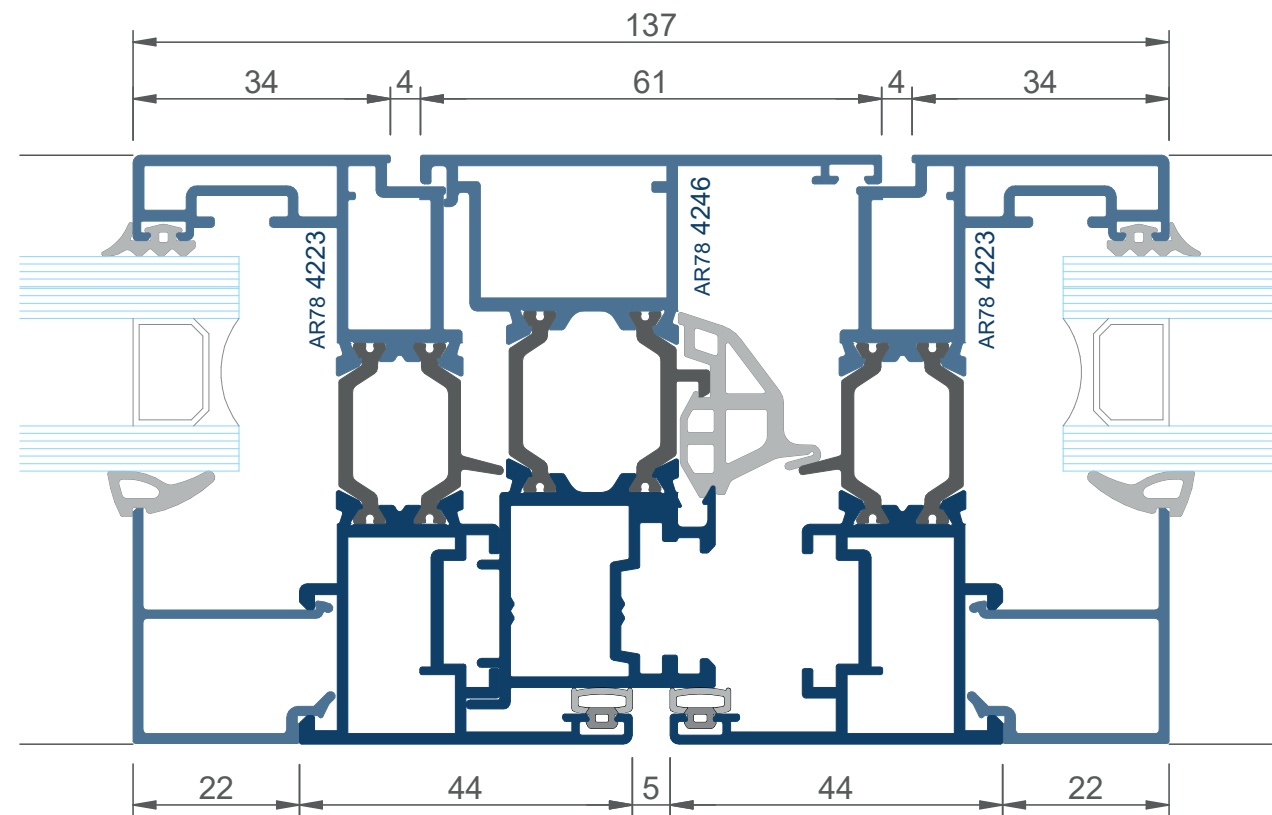

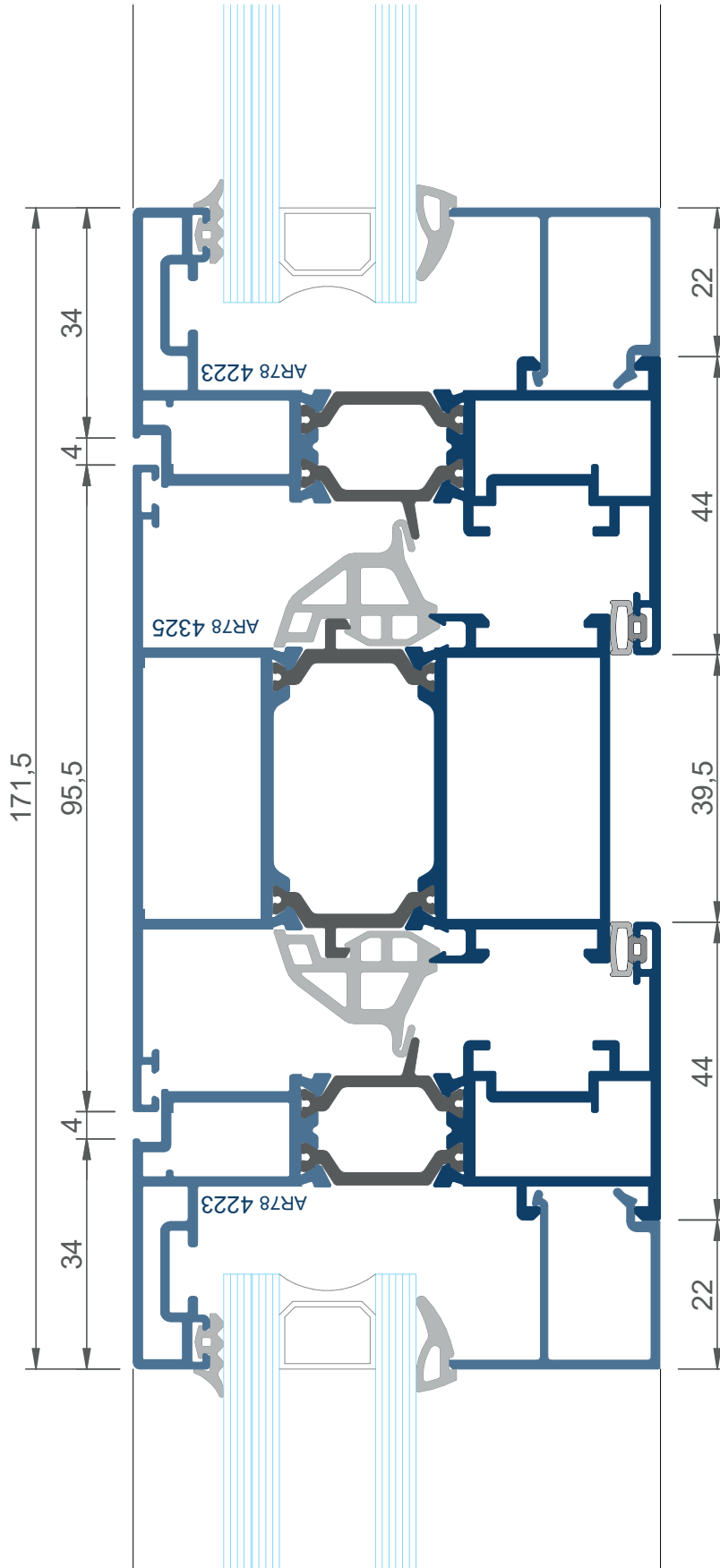

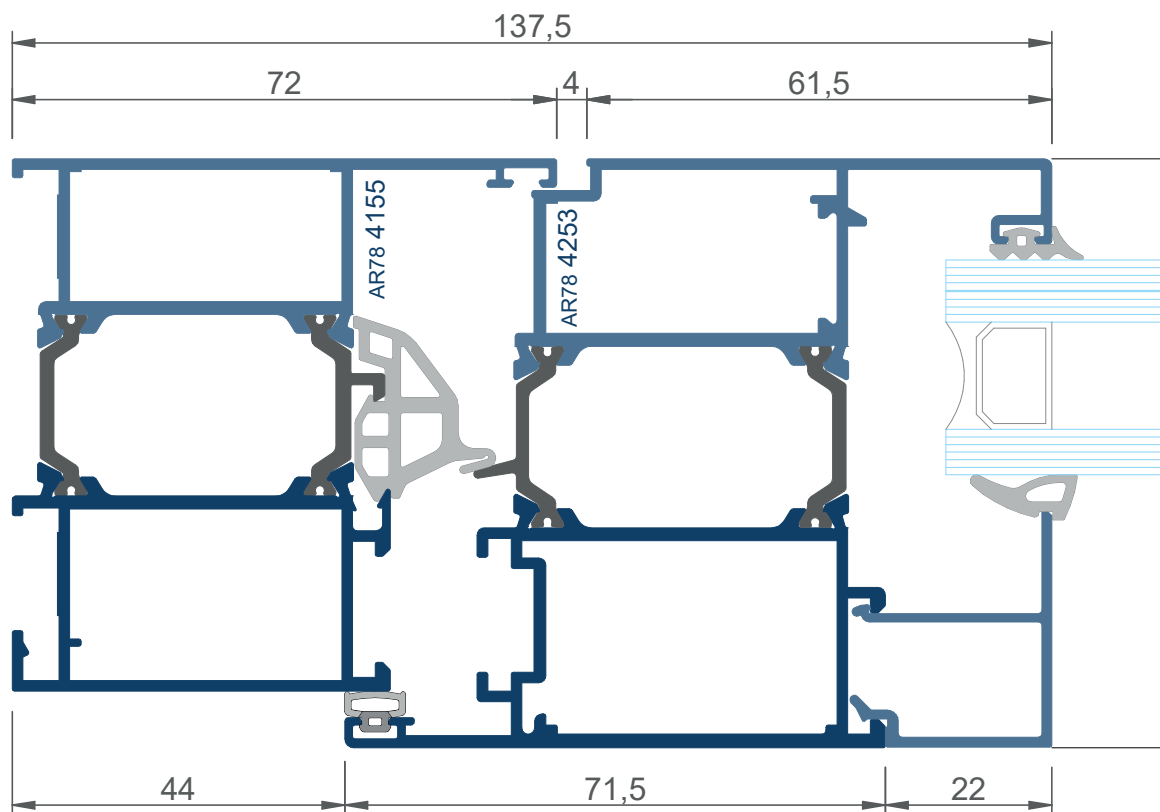
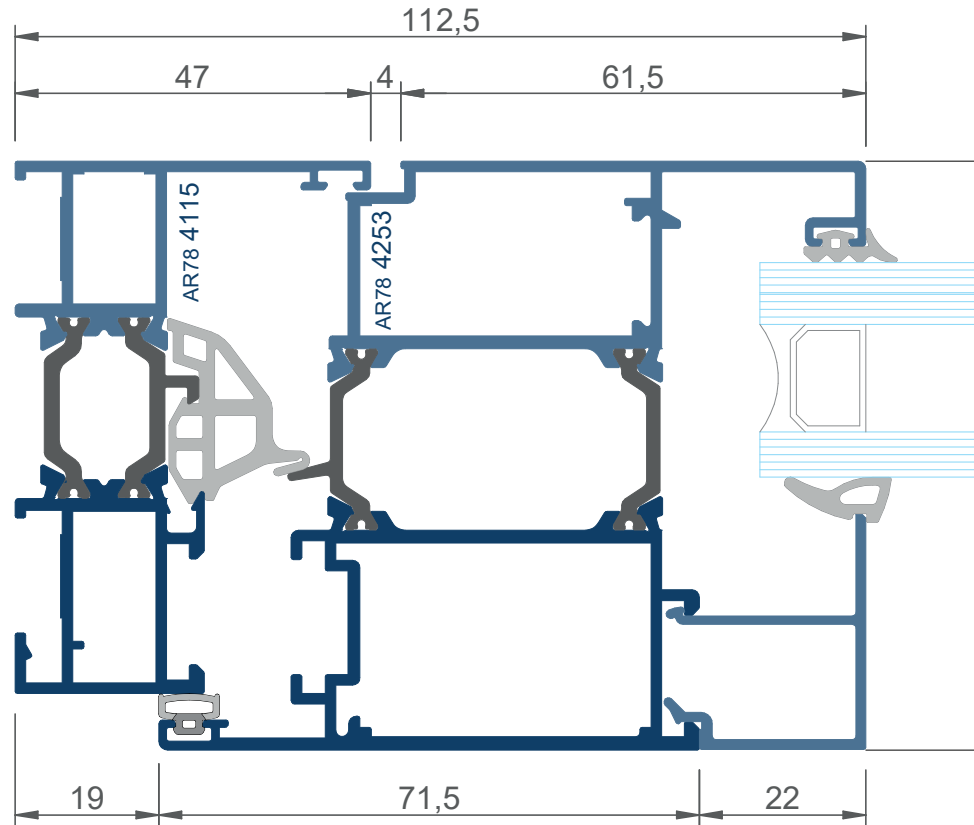

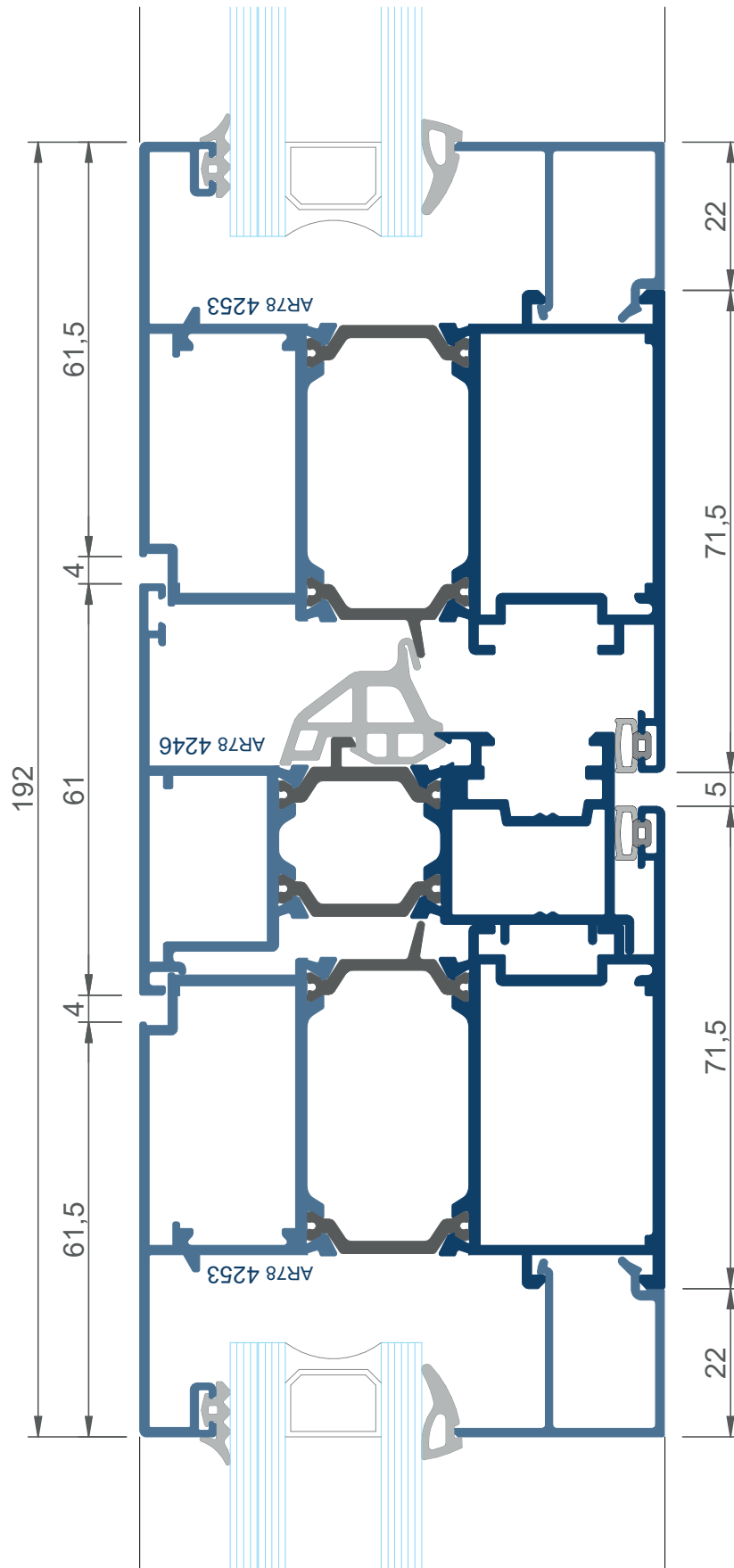

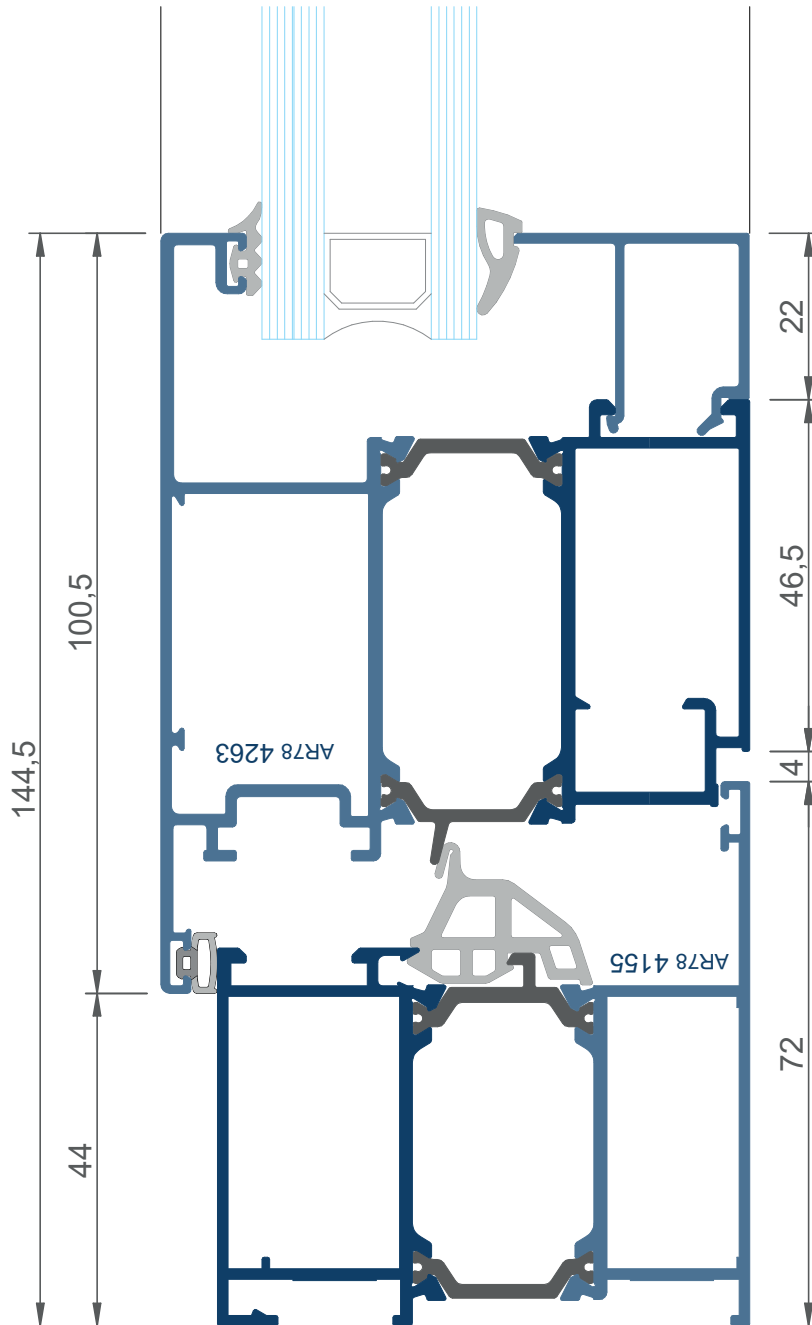

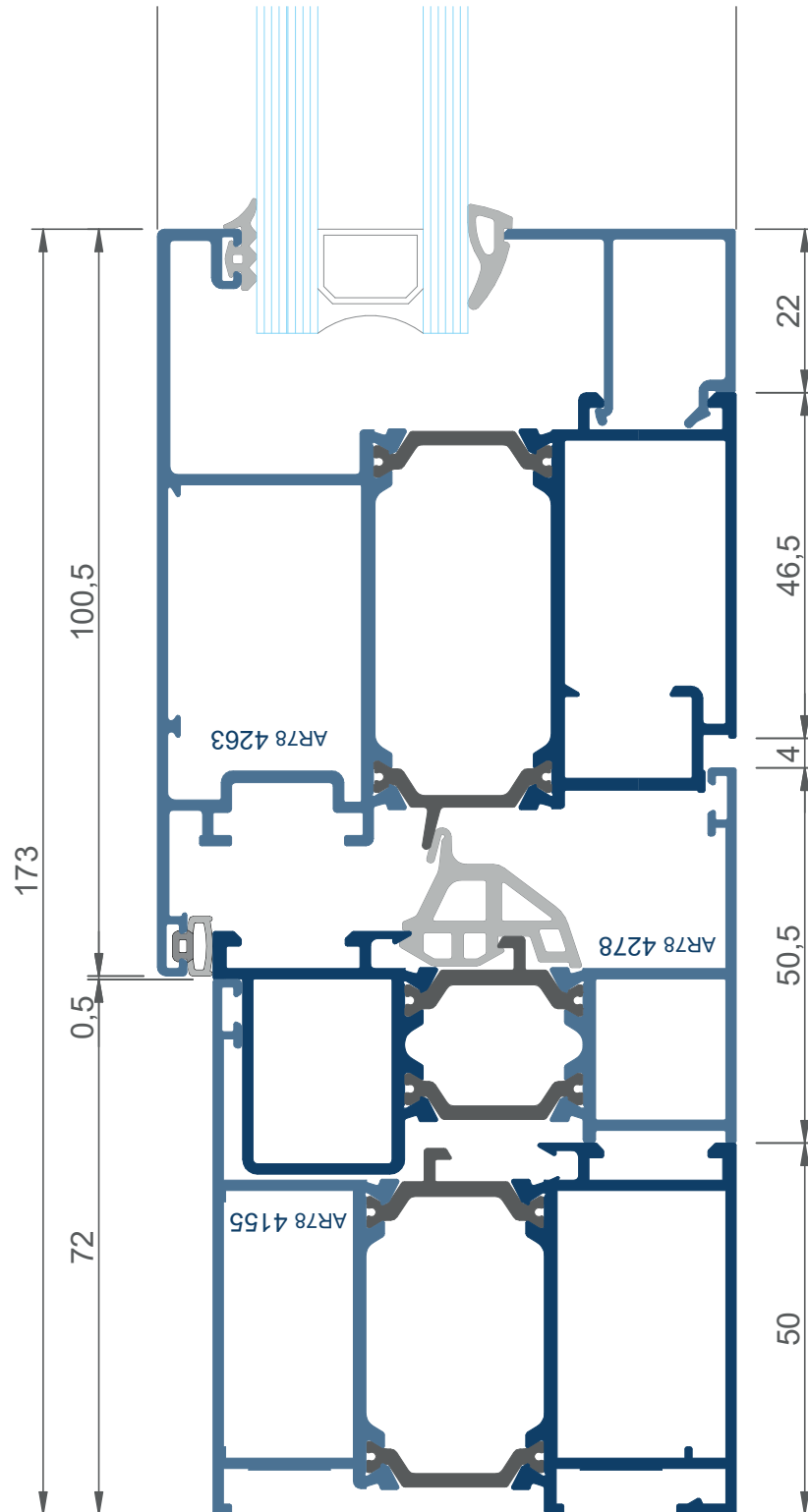

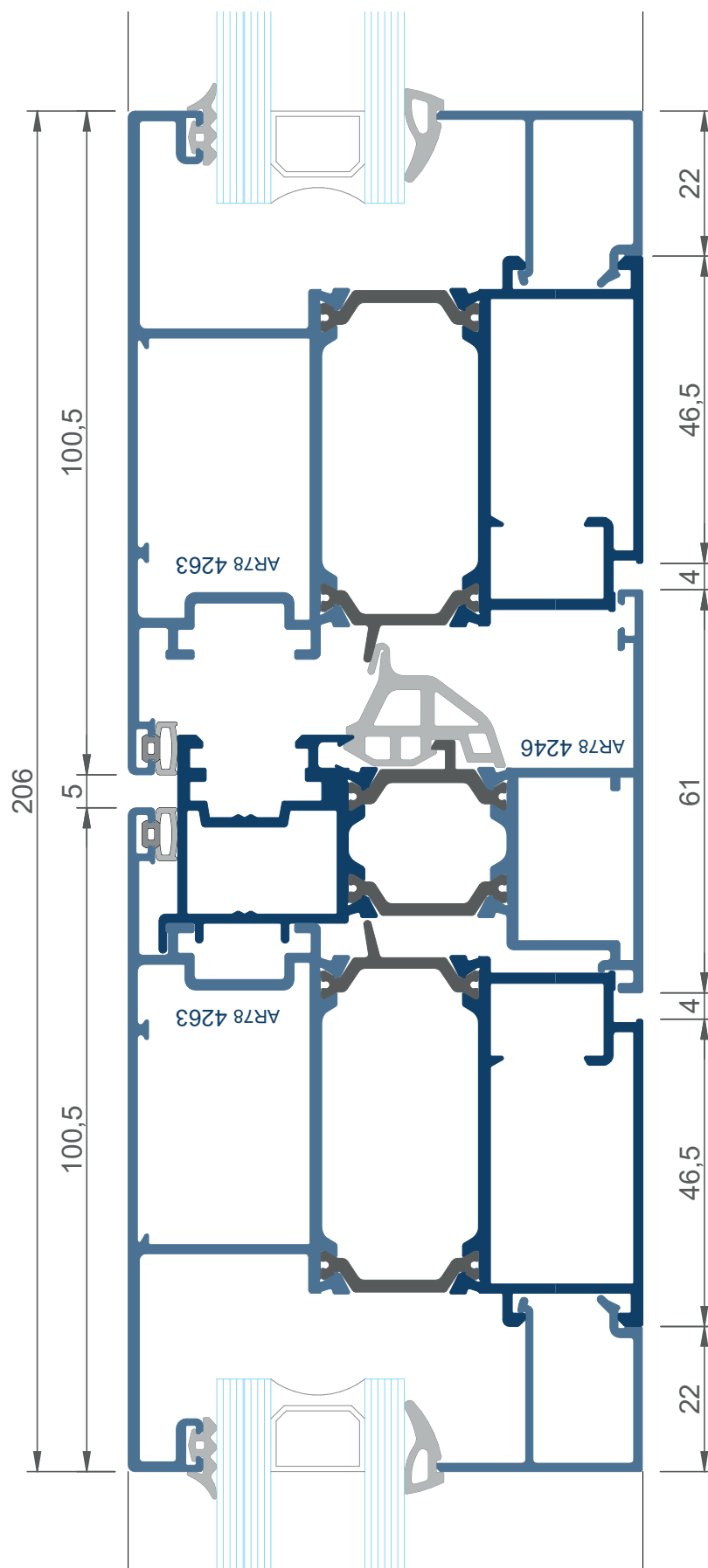

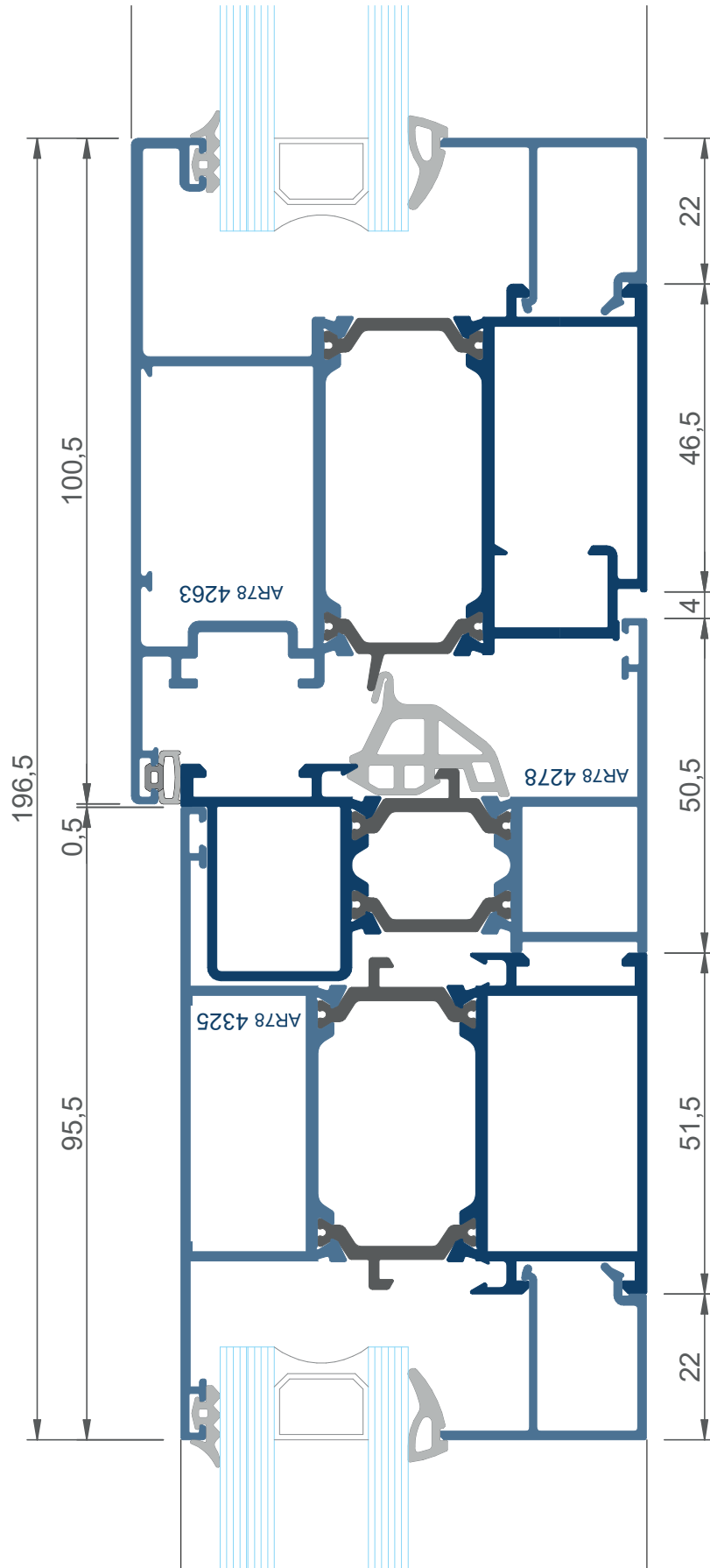

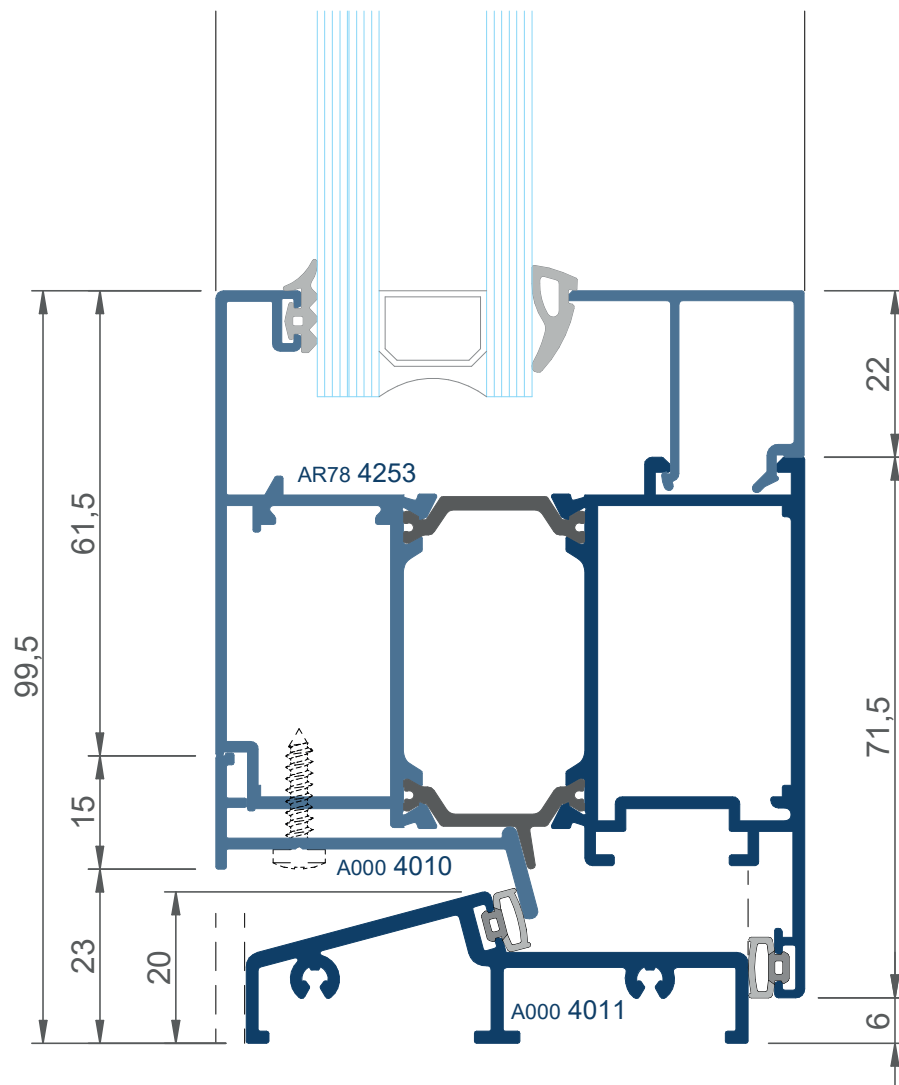

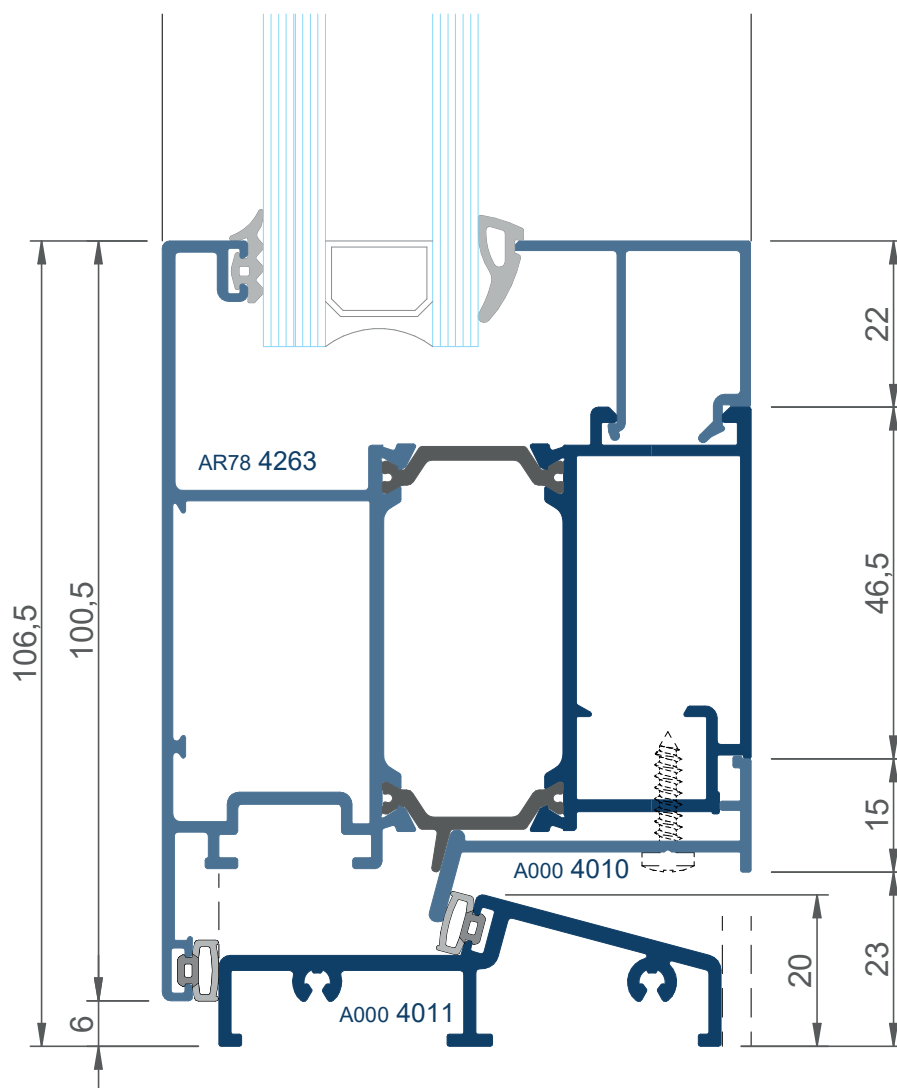

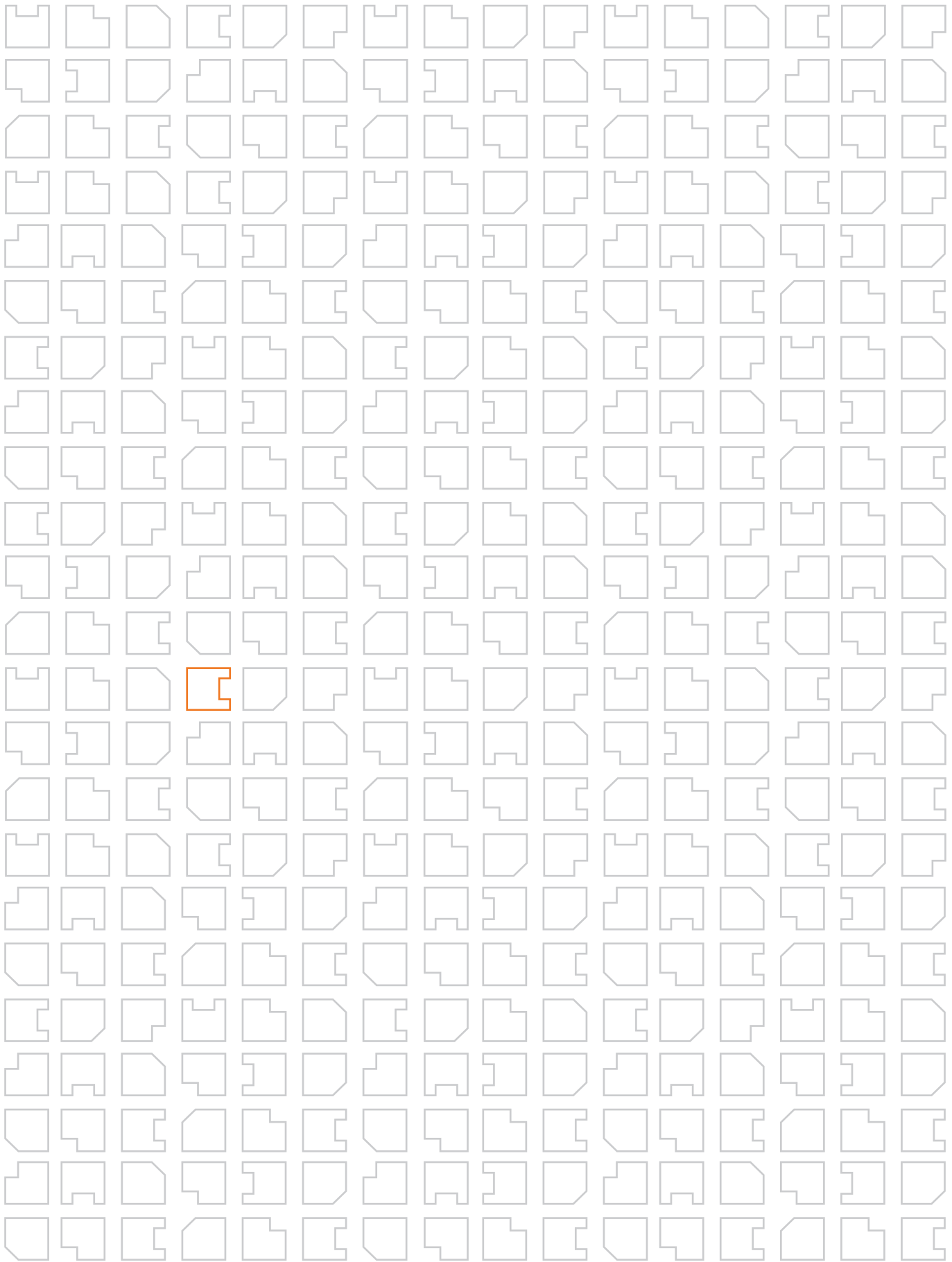

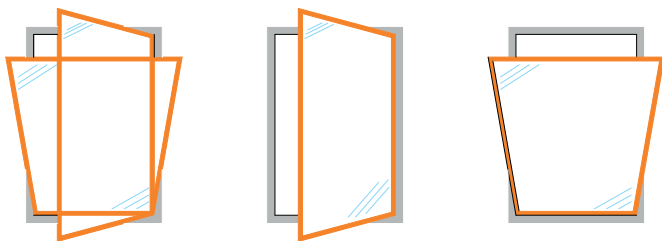

ACCESORIOS		UDS
escuadra	A000.2110	16
escuadra alineación ext hoja	A000.2140	4
escuadra alineación int hoja	A000.2132	4
deflector desagüe	A000.2301	2
ángulo esquina junta central	A000.2307	4
junta central	A000.2308	2B+2H
junta int hoja	A000.2320	2B+2H
junta ext acristalamiento	A000.2351	2B+2H
junta cuña int	A000.XXXX	2B+2H

para accesorios de maniobra consultar catálogo específico

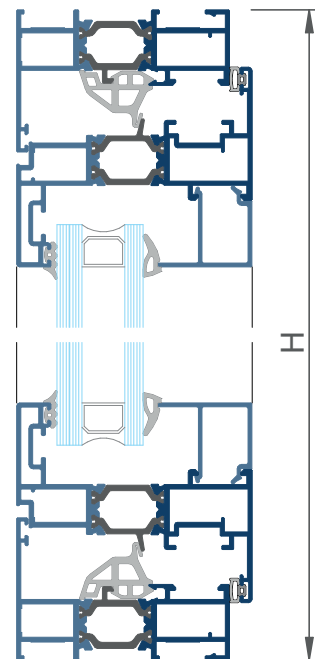

FORMULAS DE CORTE				
		UDS	FORMULA	FORMA
marco horizontal	AR78.4115	2	B	\ --- /
marco vertical	AR78.4115	2	H	\ --- /
hoja horizontal	AR78.4223	2	B-39	\ --- /
hoja vertical	AR78.4223	2	H-39	\ --- /
junquillo recto horizontal	A000.XXXX	2	B-126	---
junquillo elíptico horizontal	A000.XXXX	2	B-126	\ --- /
junquillo recto vertical	A000.XXXX	2	H-170	---
junquillo elíptico vertical	A000.XXXX	2	H-126	\ --- /
vidrio		1	B-146 x H-146	

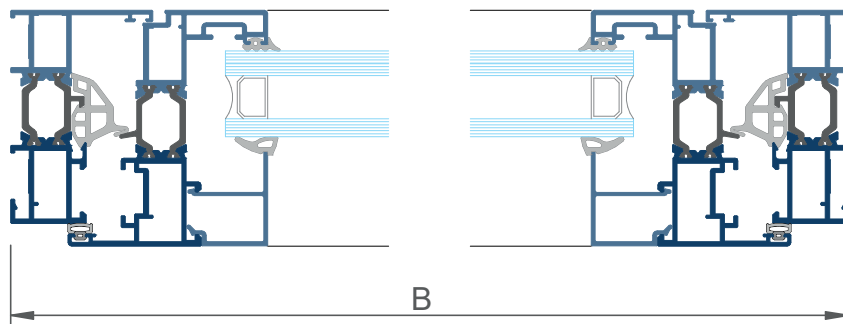

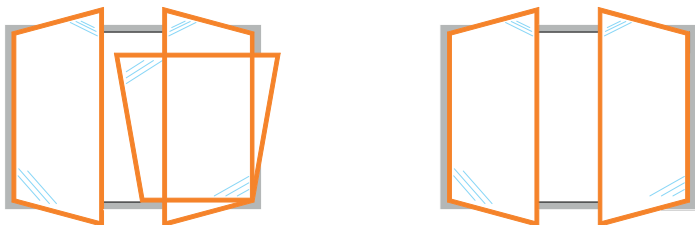

ACCESORIOS			UDS
escuadra	A000.2110		24
escuadra alineación ext hoja	A000.2140		8
escuadra alineación int hoja	A000.2132		8
deflector desagüe	A000.2301		3
ángulo esquina junta central	A000.2307		4
junta central	A000.2308	2B+3H	
junta int hoja	A000.2320	2B+4H	
junta ext acristalamiento	A000.2351	2B+4H	
junta cuña int	A000.XXXX	2B+4H	
juego tapas estanq central	A000.2340		1
juego tapas estética central	A000.2342		1

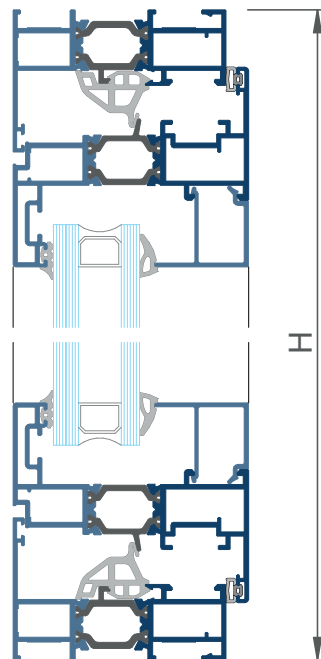

para accesorios de maniobra consultar catálogo específico

FORMULAS DE CORTE				
		UDS	FORMULA	FORMA
marco horizontal	AR78.4115	2	B	\ --- /
marco vertical	AR78.4115	2	H	\ --- /
hoja horizontal	AR78.4223	4	(B-44)/2	\ --- /
hoja vertical	AR78.4223	4	H-39	\ --- /
inversor doble hoja	AR78.4246	1	H-107	---
junquillo recto horizontal	A000.XXXX	4	(B-220)/2	---
junquillo elíptico horizontal	A000.XXXX	4	(B-220)/2	\ --- /
junquillo recto vertical	A000.XXXX	4	H-170	---
junquillo elíptico vertical	A000.XXXX	4	H-126	\ --- /
	vidrio	2	(B-259)/2 x H-146	

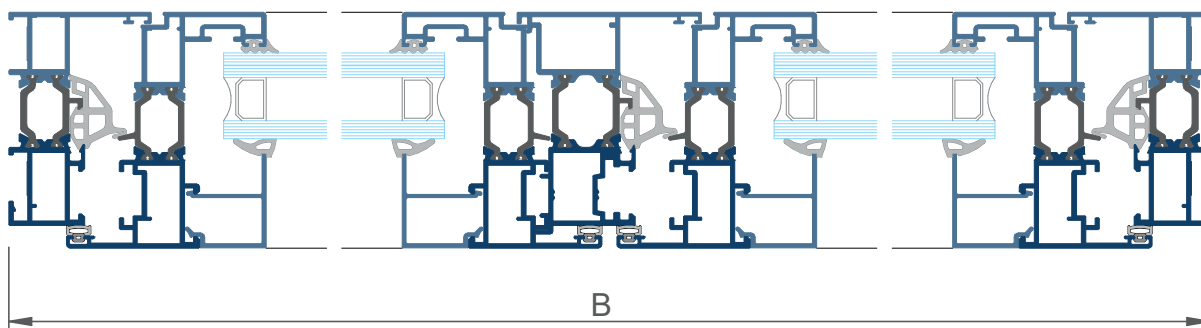

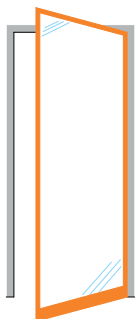

ACCESORIOS			UDS
escuadra marco	A000.2113		8
escuadra hoja	A000.2114		4
escuadra alineación int hoja	A000.2132		4
ángulo esquina junta central	A000.2307		2
junta central	A000.2308	1B+2H	
junta int hoja	A000.2320	3B+2H	
junta ext acristalamiento	A000.2351	2B+2H	
junta cuña int	A000.XXXX	2B+2H	

para accesorios de maniobra consultar catálogo específico

FORMULAS DE CORTE				
		UDS	FORMULA	FORMA
marco horizontal	AR78.4155	1	B	\ --- /
marco vertical	AR78.4155	2	H	- / \ -
hoja horizontal	AR78.4253	2	B-88	\ --- /
hoja vertical	AR78.4253	2	H-50	\ --- /
perfil hoja bajo puerta	A000.4010	1	B-123	---
perfil umbral bajo puerta	A000.4010	1	B-91	---
junquillo recto horizontal	A000.XXXX	2	B-231	---
junquillo elíptico horizontal	A000.XXXX	2	B-231	\ --- /
junquillo recto vertical	A000.XXXX	2	H-237	---
junquillo elíptico vertical	A000.XXXX	2	H-193	\ --- /
vidrio		1	B-249 x H-213	

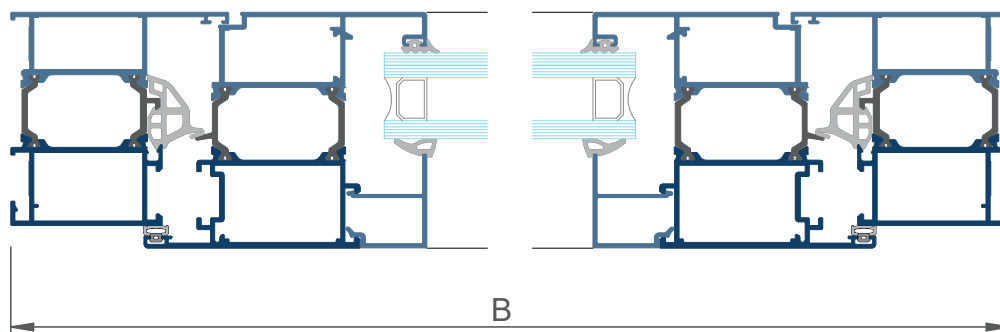
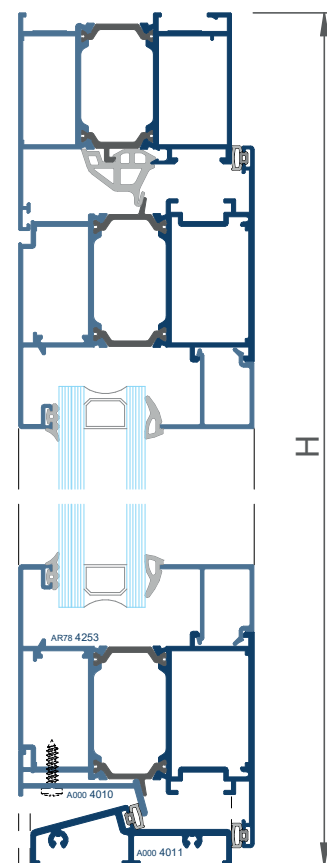

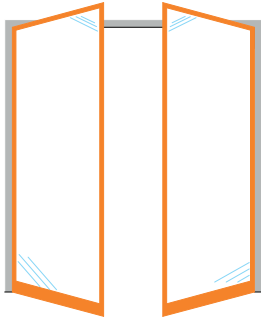

ACCESORIOS		
		UDS
escuadras "13"	A000.2113	12
escuadras "14"	A000.2114	8
escuadra alineación int hoja	A000.2132	8
ángulo esquina junta central	A000.2307	2
junta central	A000.2308	1B+3H
junta int hoja	A000.2320	2B+4H
junta ext acristalamiento	A000.2351	3B+4H
junta cuña int	A000.XXXX	2B+4H
juego tapas estanq central	A000.2340	1
juego tapas estética central	A000.2342	1

para accesorios de maniobra consultar catálogo específico

FORMULAS DE CORTE				
		UDS	FORMULA	FORMA
marco horizontal	AR78.4155	1	B	\ --- /
marco vertical	AR78.4155	2	H	- / \ -
hoja horizontal	AR78.4253	4	(B-93)/2	\ --- /
hoja vertical	AR78.4253	4	H-50	\ --- /
inversor doble hoja	AR78.4246	1	H-118	---
perfil hoja bajo puerta	A000.4010	1	(B-163)/2	---
perfil hoja bajo puerta	A000.4010	1	(B-92)/2	---
perfil umbral bajo puerta	A000.4011	1	B-91	---
junquillo recto horizontal	A000.XXXX	4	(B-379)/2	---
junquillo elíptico horizontal	A000.XXXX	4	(B-379)/2	\ --- /
junquillo recto vertical	A000.XXXX	4	H-237	---
junquillo elíptico vertical	A000.XXXX	4	H-193	\ --- /
	vidrio	2	(B-415)/2 x H-211	

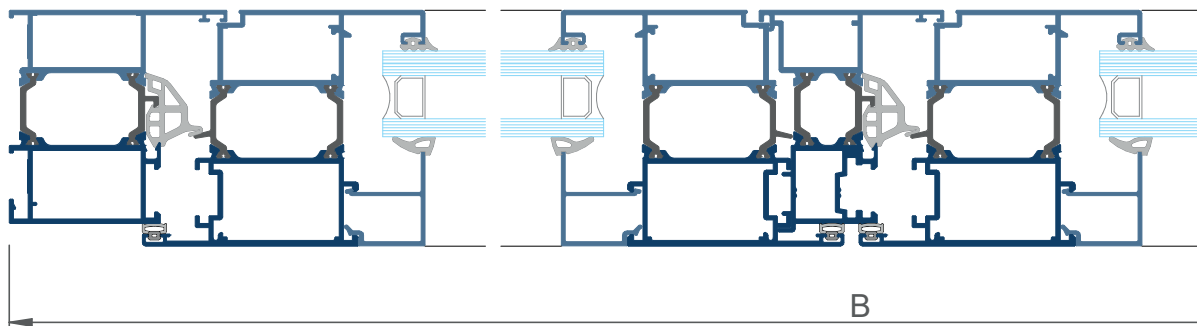
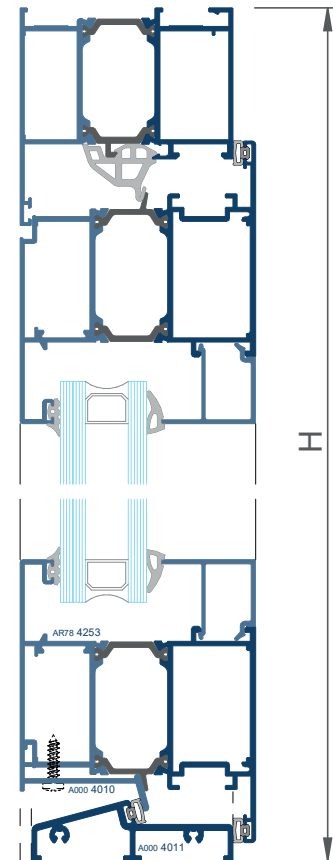

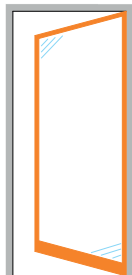

ACCESORIOS			UDS
escuadra marco	A000.2113		4
escuadra ext hoja	A000.2114		4
escuadra int hoja	A000.2110		4
escuadra alineación int hoja	A000.2132		4
ángulo esquina junta central	A000.2307		2
junta central	A000.2308	1B+2H	
junta int hoja	A000.2320	3B+2H	
junta ext acristalamiento	A000.2351	2B+2H	
junta cuña int	A000.XXXX	2B+2H	

para accesorios de maniobra consultar catálogo específico

FORMULAS DE CORTE				
		UDS	FORMULA	FORMA
marco horizontal	AR78.4155	1	B	\---/
marco vertical	AR78.4155	2	H	-/ -
hoja horizontal	AR78.4263	2	B-88	\---/
hoja vertical	AR78.4263	2	H-50	\---/
perfil hoja bajo puerta	A000.4010	1	B-123	---
perfil umbral bajo puerta	A000.4011	1	B-91	---
junquillo recto horizontal	A000.XXXX	2	B-245	---
junquillo elíptico horizontal	A000.XXXX	2	B-245	\---/
junquillo recto vertical	A000.XXXX	2	H-251	---
junquillo elíptico vertical	A000.XXXX	2	H-207	\---/
	vidrio	1	B-262 x H-224	

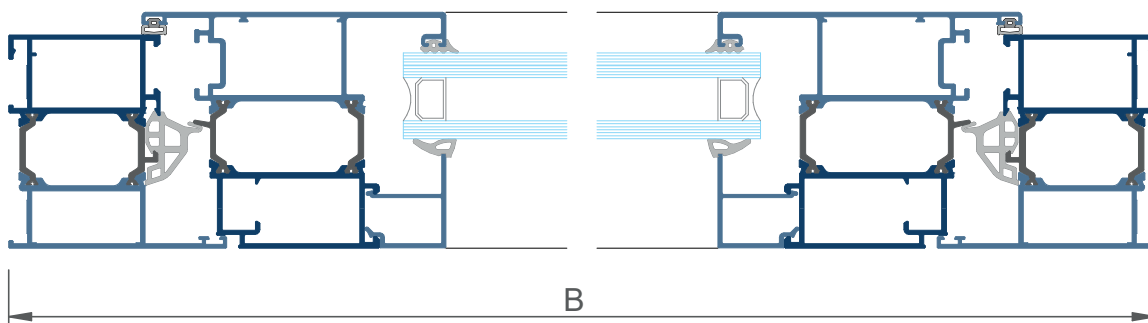
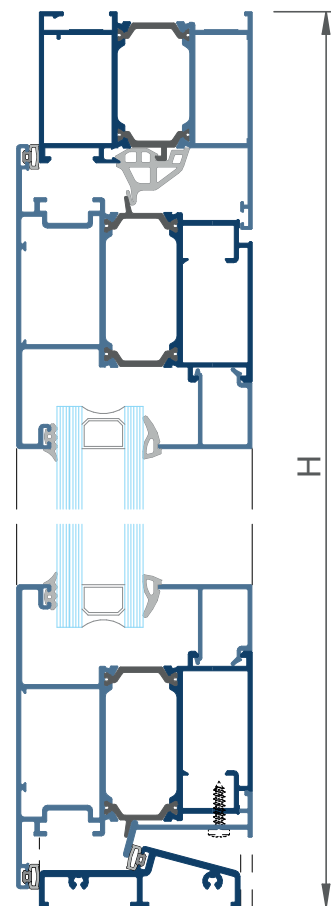

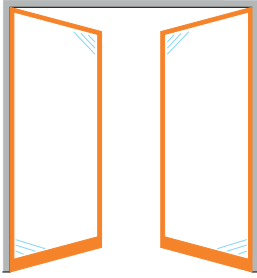

ACCESORIOS			UDS
escuadra marco	A000.2113	4	
escuadra ext hoja	A000.2114	8	
escuadra int hoja	A000.2110	8	
escuadra alineación int hoja	A000.2132	8	
ángulo esquina junta central	A000.2307	2	
junta central	A000.2308	1B+3H	
junta int hoja	A000.2320	3B+4H	
junta ext acristalamiento	A000.2351	2B+4H	
junta cuña int	A000.XXXX	2B+4H	
juego tapas estanq central	A000.2340	1	
juego tapas estética central	A000.2342	1	

para accesorios de maniobra consultar catálogo específico

FORMULAS DE CORTE				
		UDS	FORMULA	FORMA
marco horizontal	AR78.4155	1	B	\ --- /
marco vertical	AR78.4155	2	H	- / \ -
hoja horizontal	AR78.4263	4	(B-93)/2	\ --- /
hoja vertical	AR78.4263	4	H-50	\ --- /
inversor doble hoja	AR78.4246	1	H-118	---
perfil hoja bajo puerta	A000.4010	1	(B-163)/2	---
perfil hoja bajo puerta	A000.4010	1	(B-92)/2	---
perfil umbral bajo puerta	A000.4011	1	B-91	---
junquillo recto horizontal	A000.XXXX	4	(B-407)/2	---
junquillo elíptico horizontal	A000.XXXX	4	(B-407)/2	\ --- /
junquillo recto vertical	A000.XXXX	4	H-251	---
junquillo elíptico vertical	A000.XXXX	4	H-207	\ --- /
	vidrio	2	(B-440)/2 x H-224	

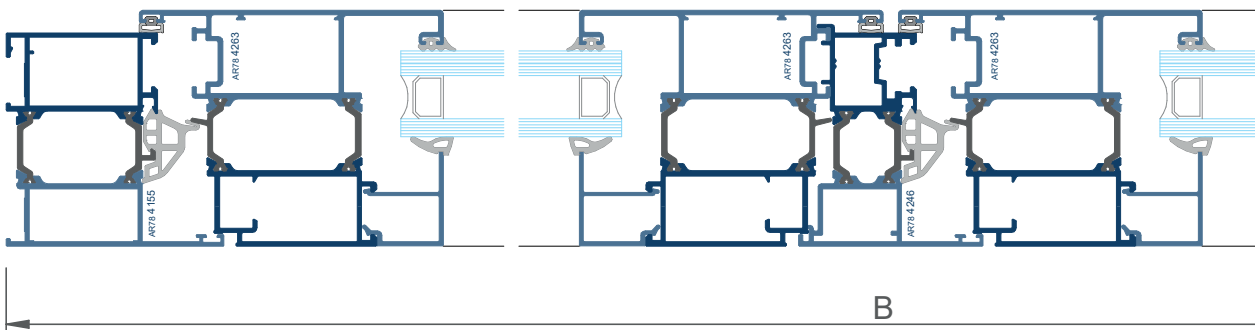
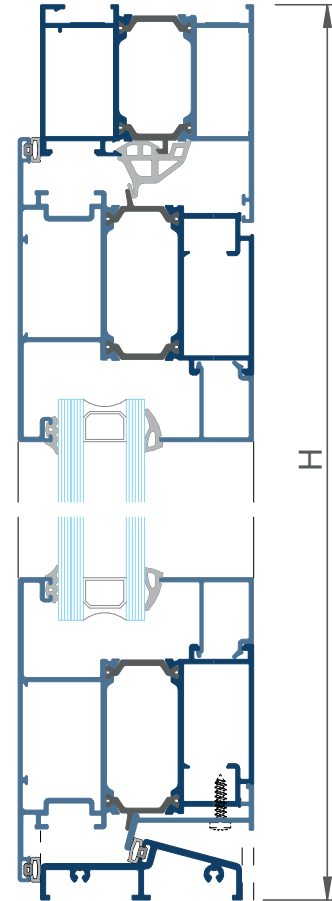

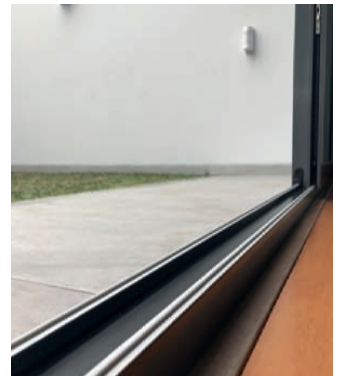
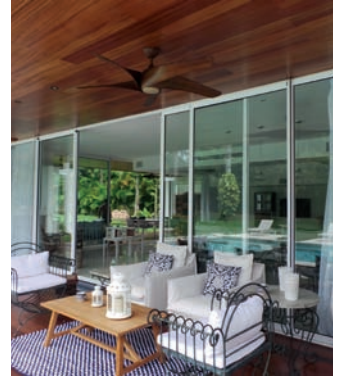
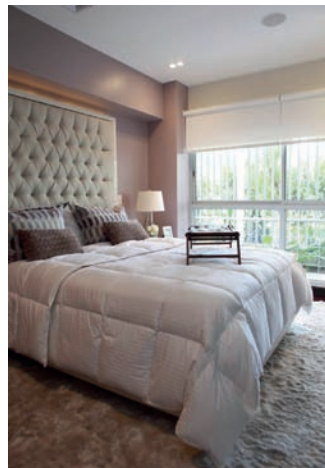
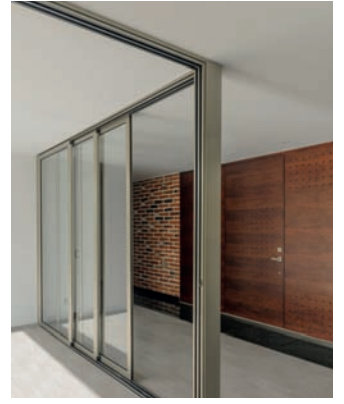
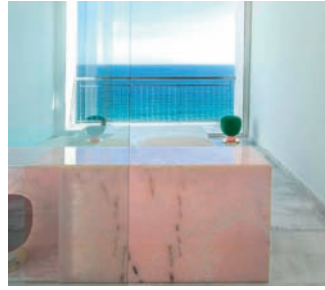
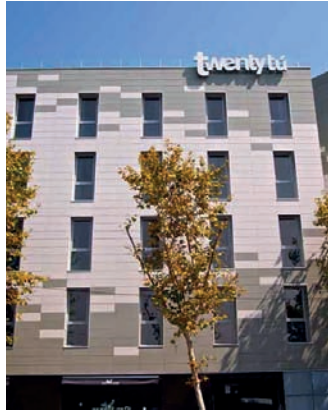

Lined area for notes with horizontal dashed lines.

THERMIA[®]

B A R C E L O N A

Ventanas para vivir mejor

Sede Central en Barcelona

C/ Narcís Monturiol, 34
08192 Sant Quirze del Vallès
Barcelona (España)
Tel. +34 937 121 237
contacto@thermiabarcelona.com
Síguenos en   

Delegación Área Andina

Los Telares, 289
Urbanización Industrial Vulcano
Ate, Lima (Perú)
Tel. +51-1-7197649

Showrooms

Barcelona

Narcís Monturiol, 34
08192 Sant Quirze Valles
Tel. +34 937 121 237

Lima

Paseo de la República, 3583
2o. Piso - San Isidro
Tel. +51-1-7197649

Girona

Carrer Sant Jordi, 2
Local 4 - Sarrià de Ter
Tel. +34 937 121 237

THERMIABARCELONA.COM