



THERMIA® AR52

Aislamiento térmico y acústico para todos.

Ventanas para vivir mejor

PERMEABILIDAD AL AIRE según EN 12207 - Mercado CE según EN 14351-1:2006 (E.1)

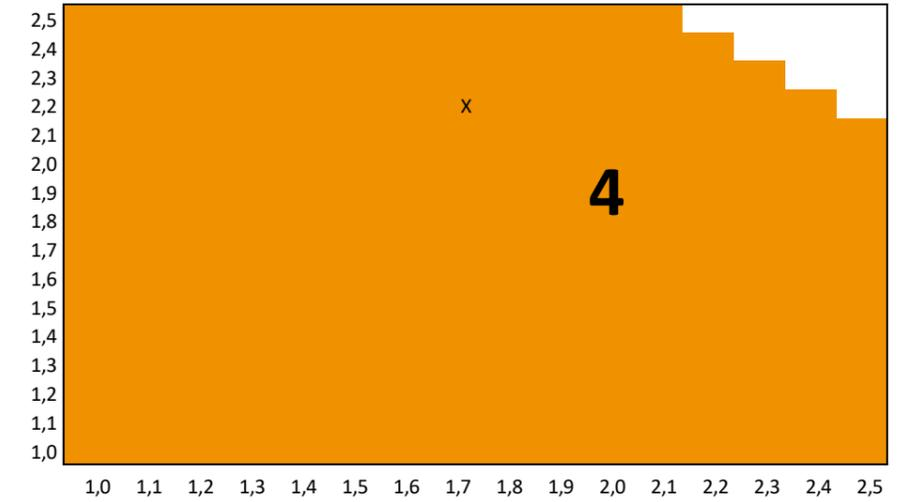

ESTANQUIDAD AL AGUA según EN 12208 - Mercado CE según EN 14351-1:2006 (E.1)

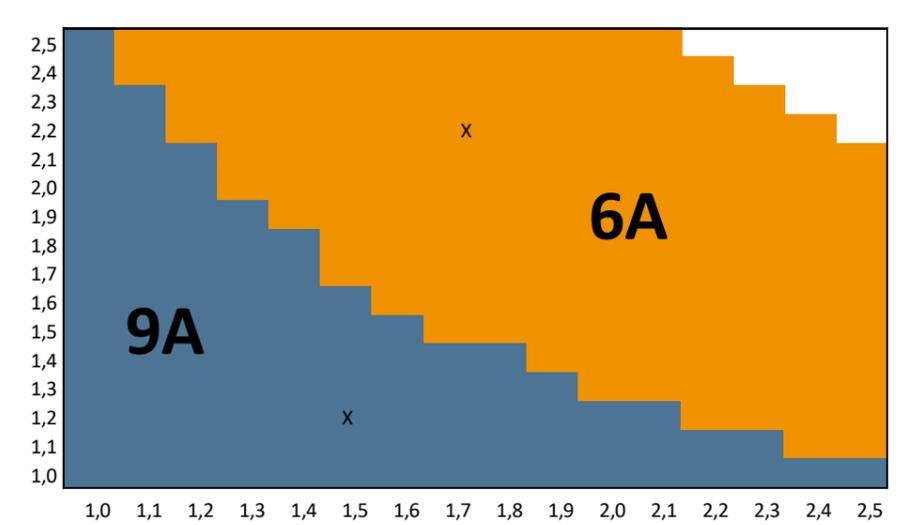

RESISTENCIA AL VIENTO según EN 12210 - Mercado CE según EN 14351-1:2006 (E.1)

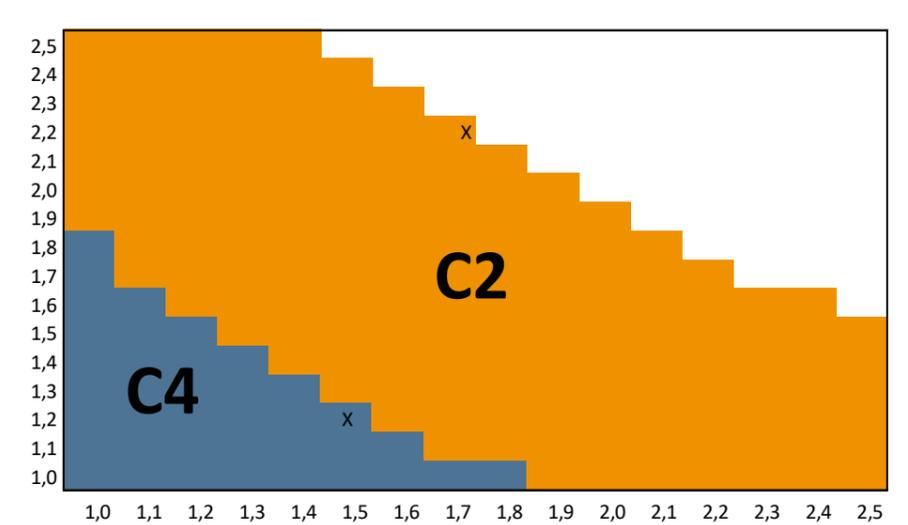

Resultados obtenidos de los informes según ensayos internos, y en base al Anexo E de la norma EN 14351-1:2006.

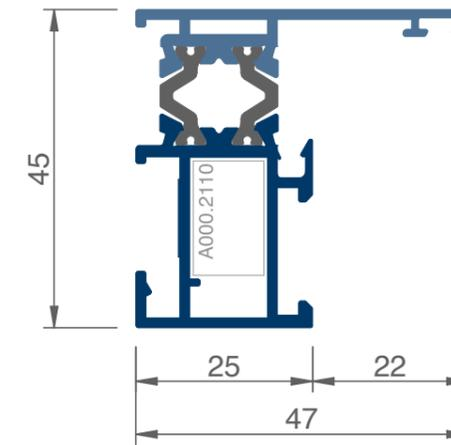
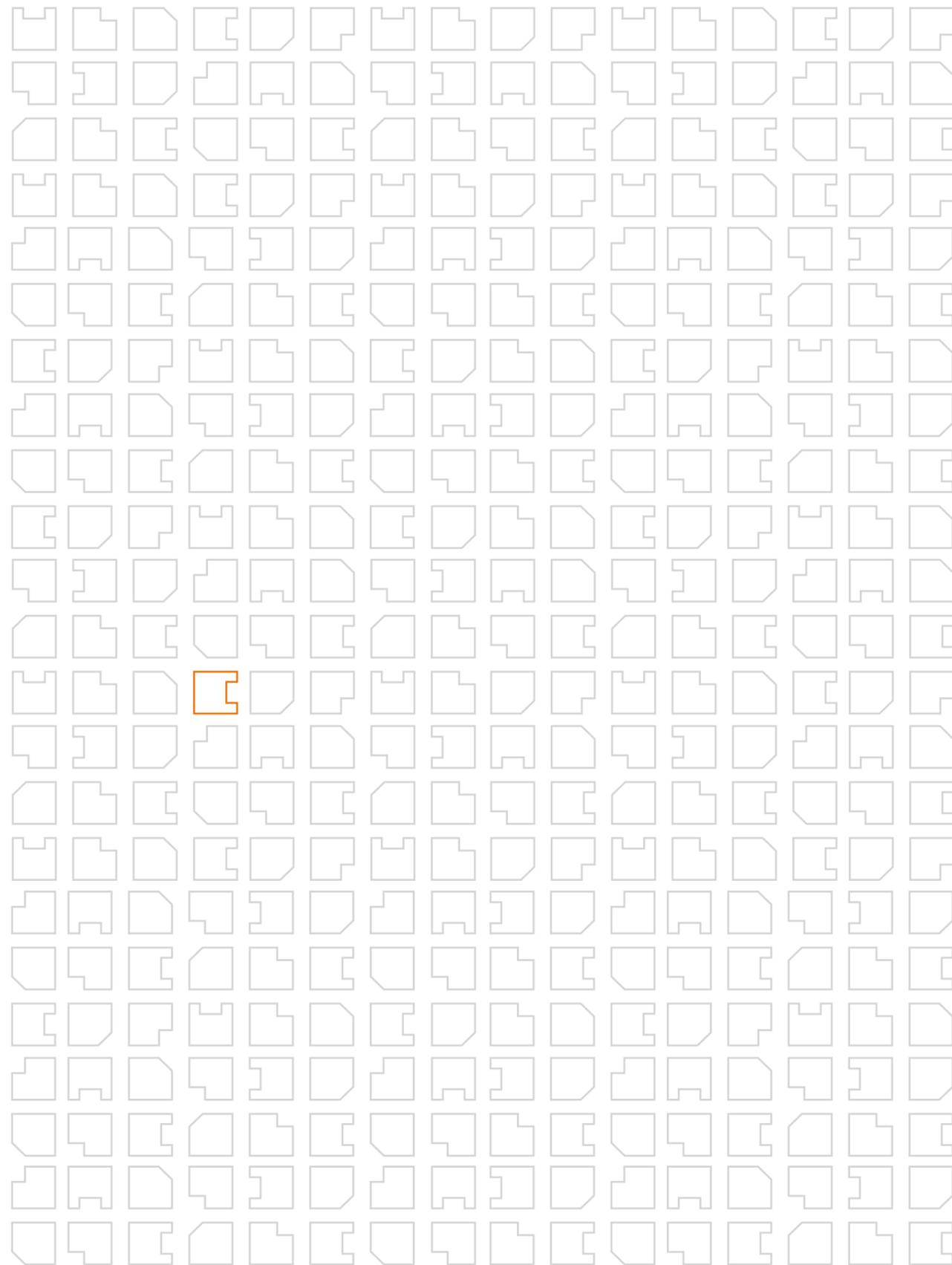

AR52 4110

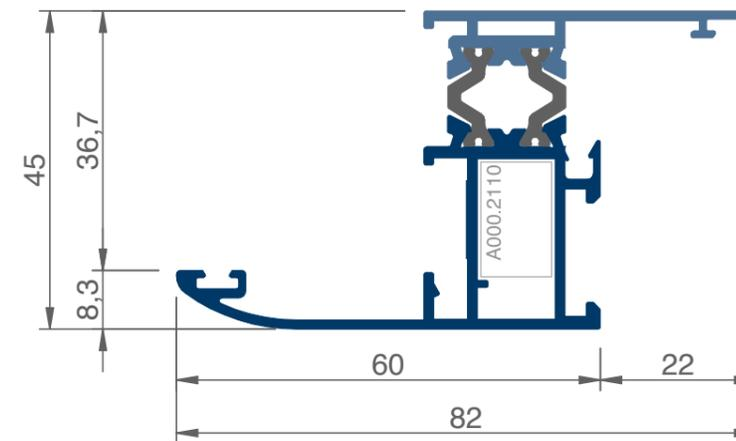

AR52 4112

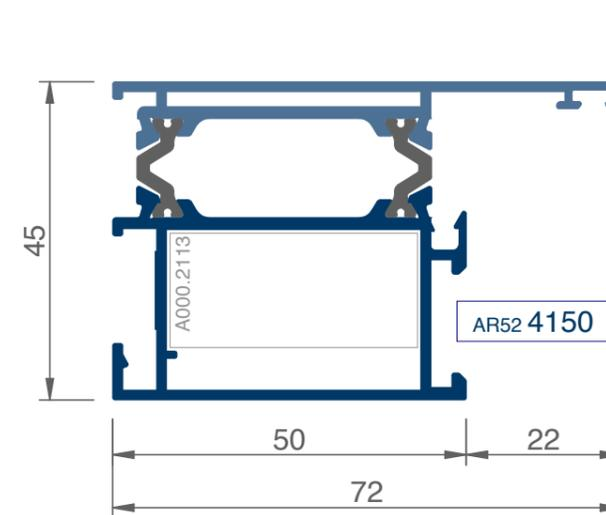

AR52 4150

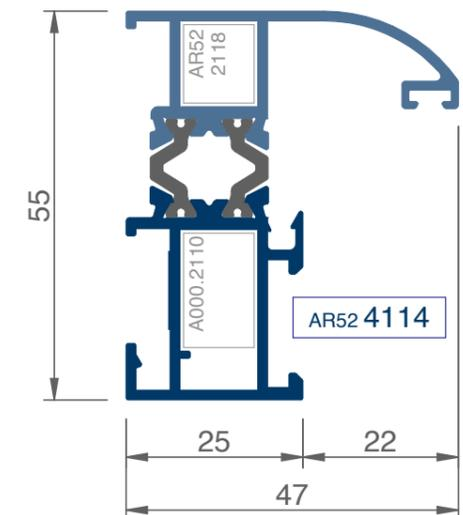

AR52 4114

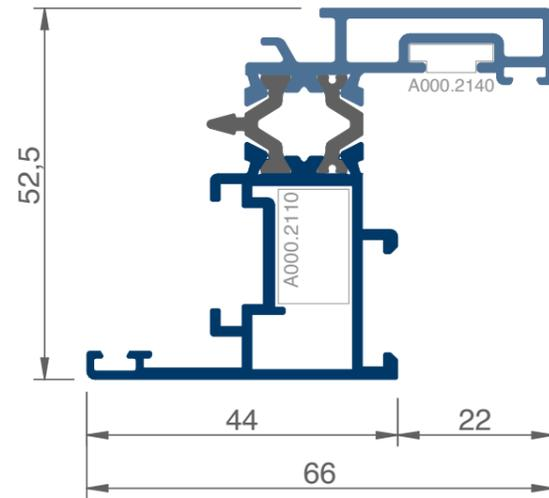

AR52 4223

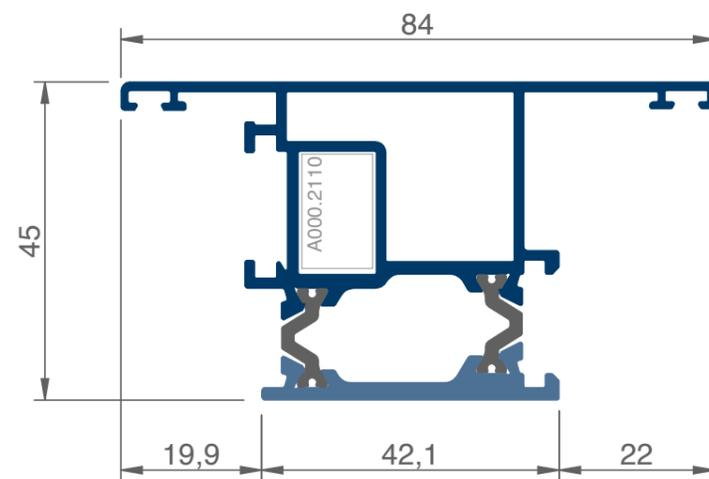

AR52 4270

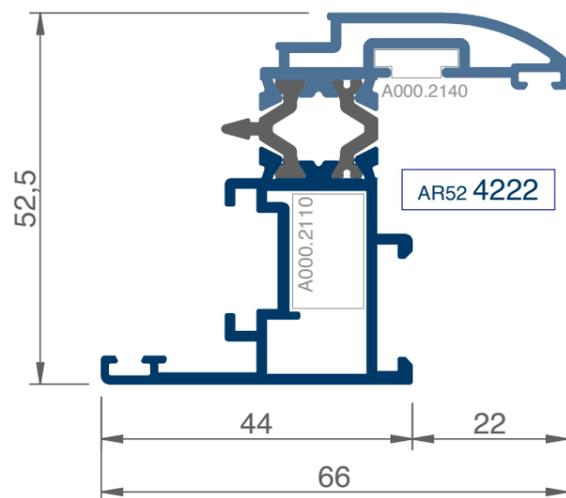

AR52 4222

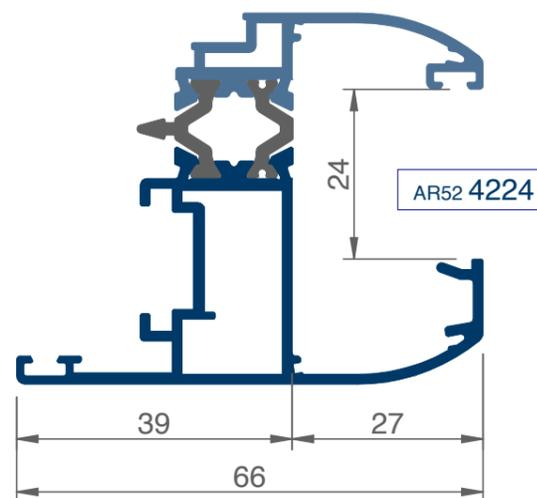

AR52 4224

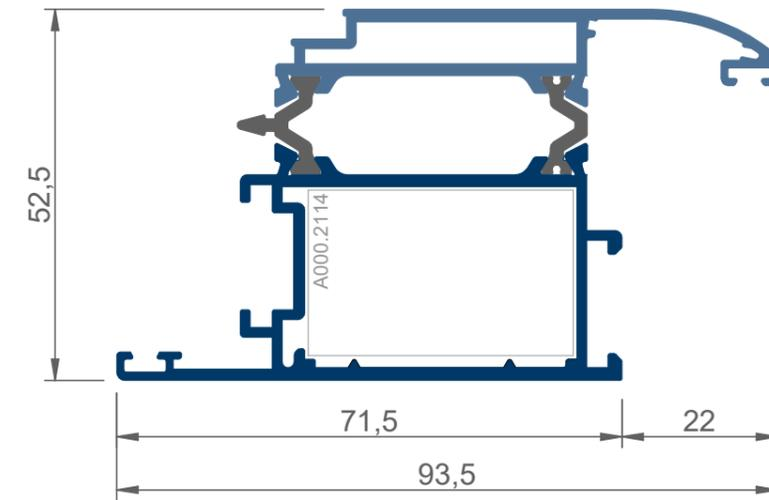

AR52 4250

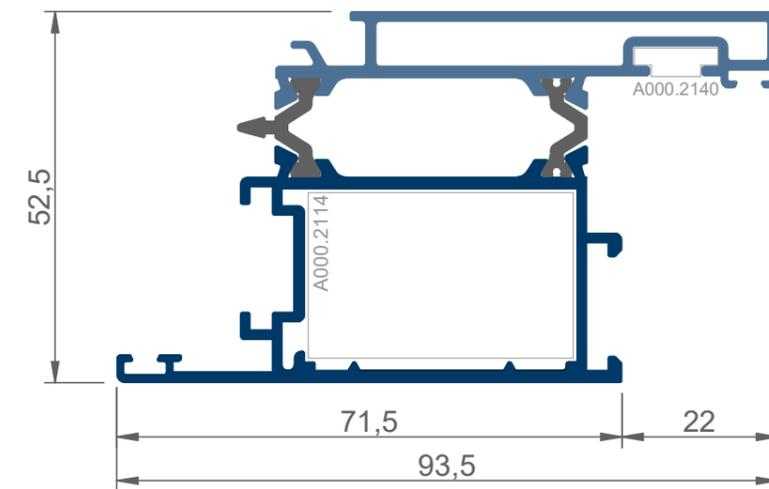

AR52 4253

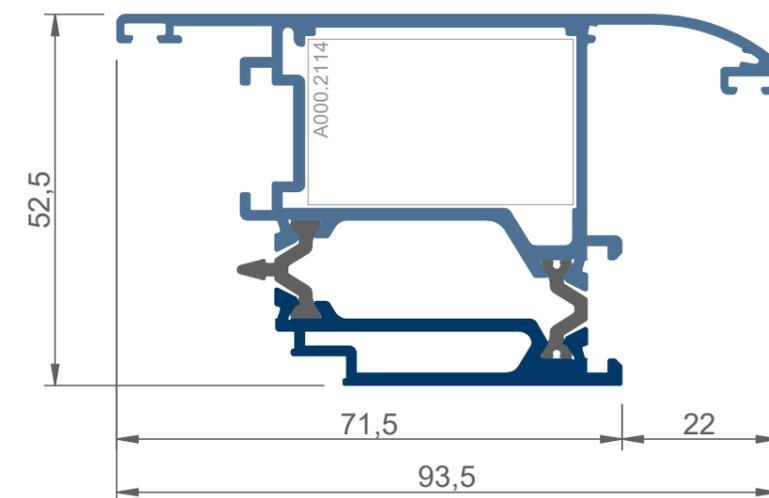

AR52 4260

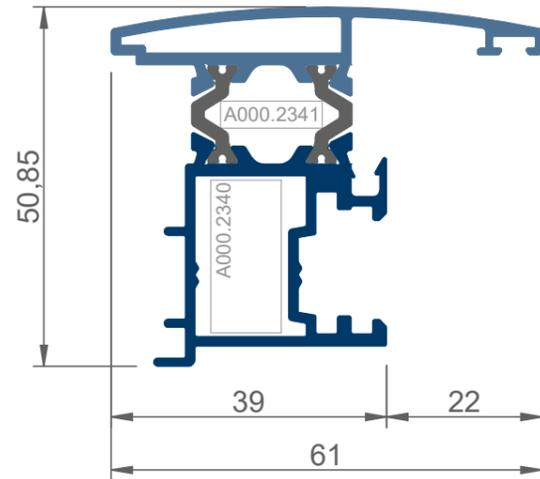

AR52 4240

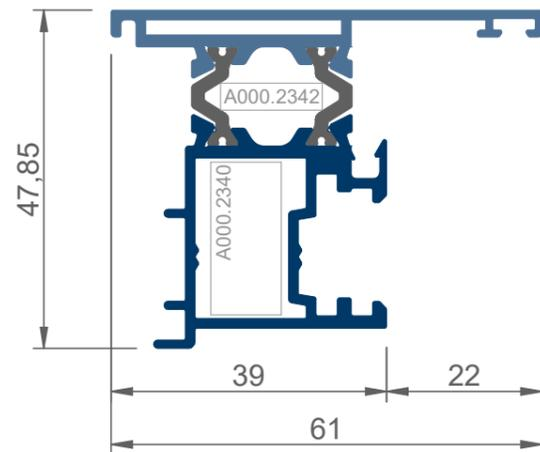

AR52 4241

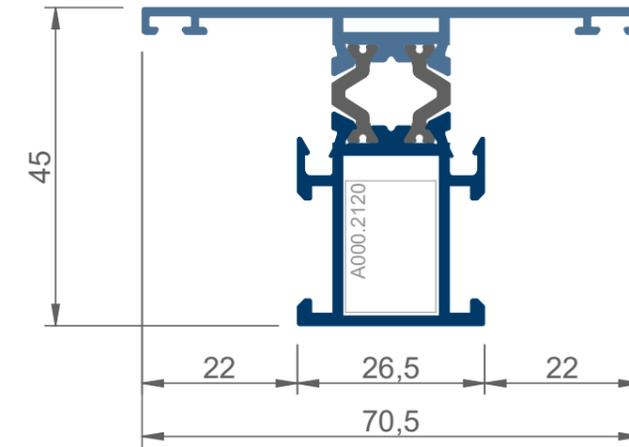

AR52 4310

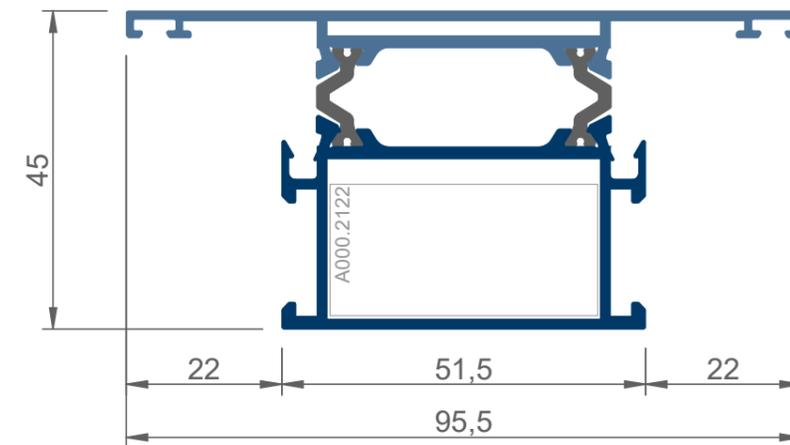

AR52 4320

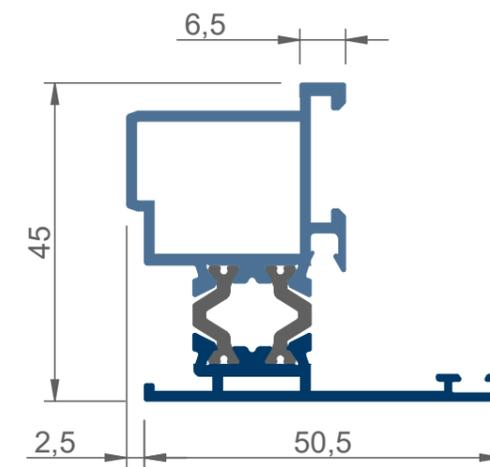

AR52 4278

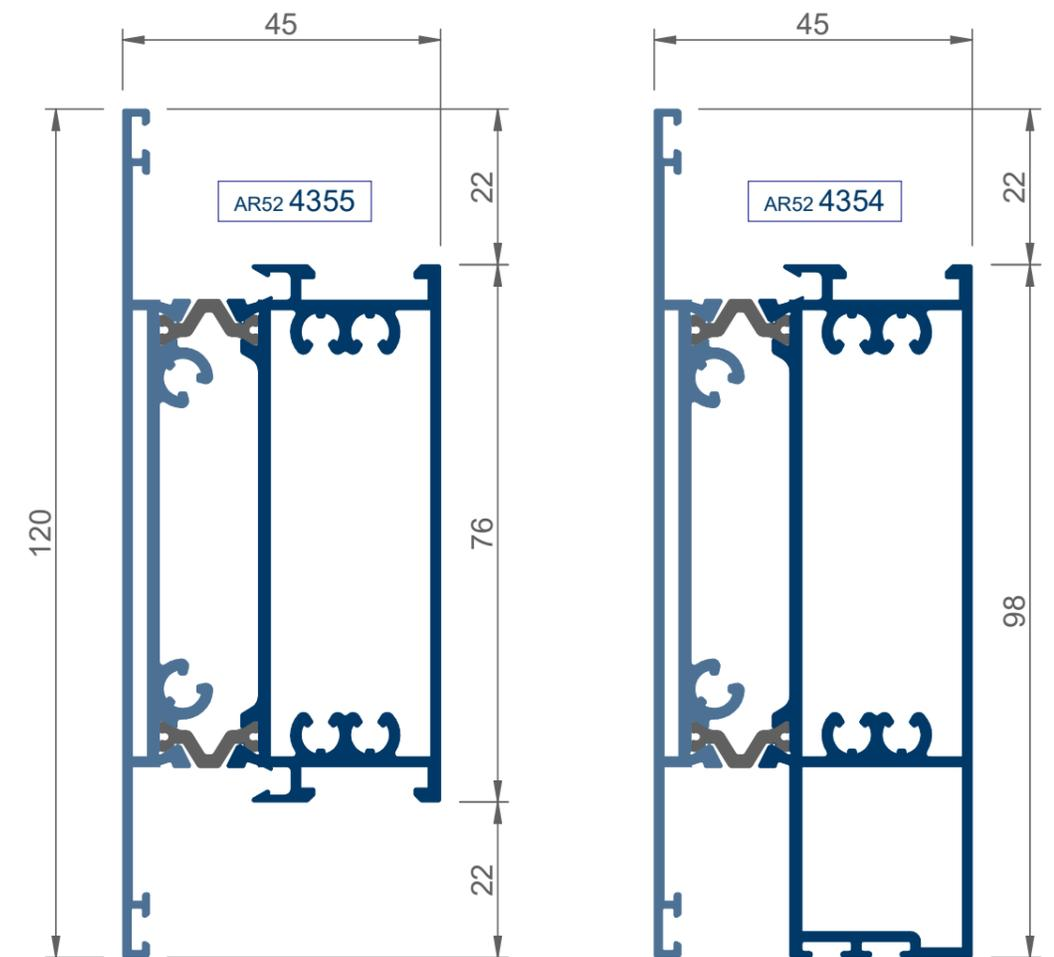
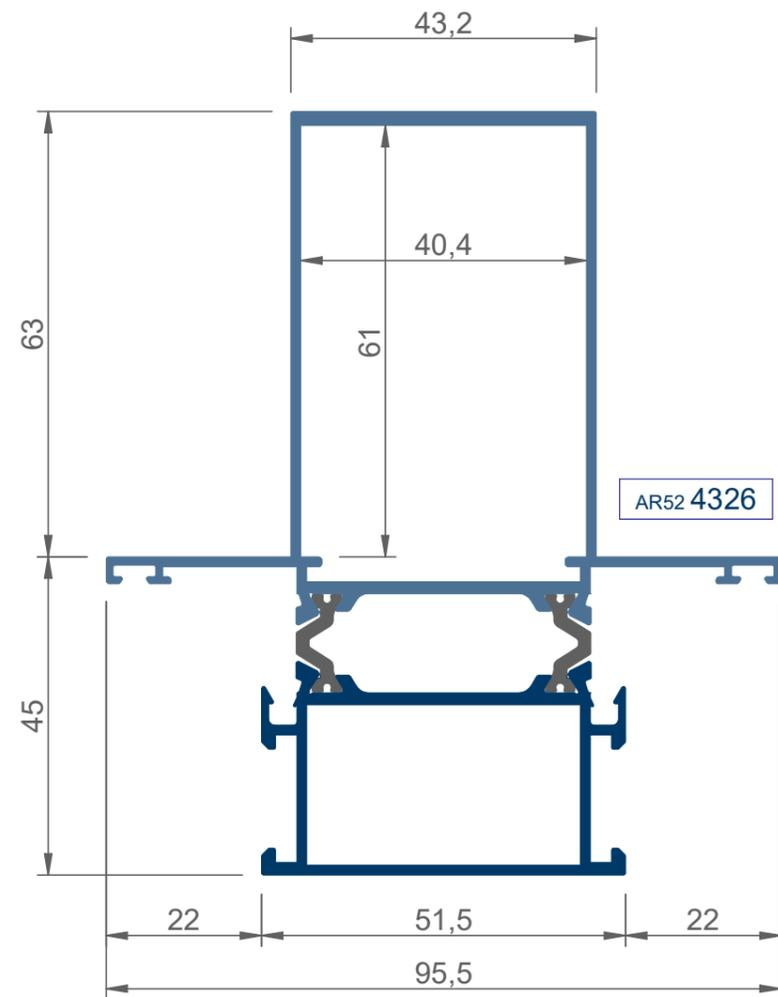

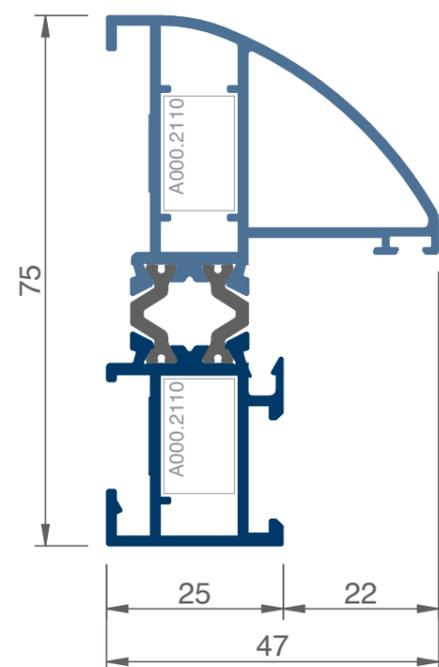

CR31 4952

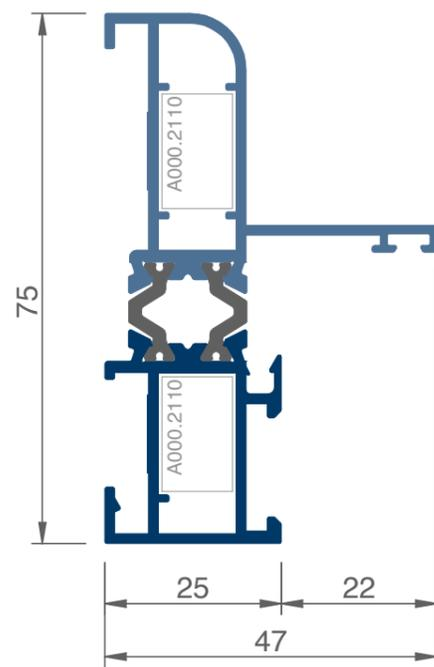

CR31 4958

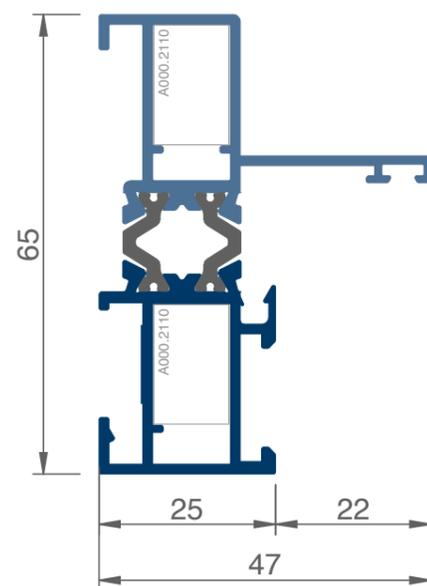

CR40 4165

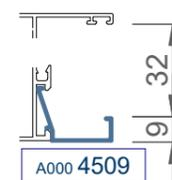

A000 4509

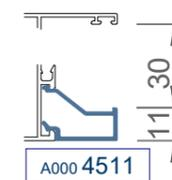

A000 4511

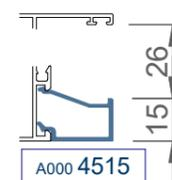

A000 4515

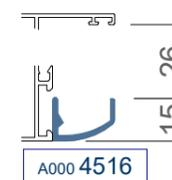

A000 4516

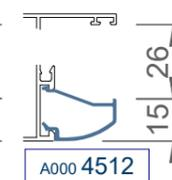

A000 4512

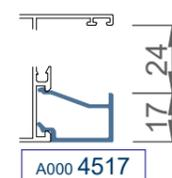

A000 4517

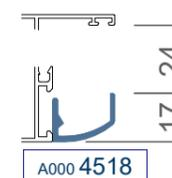

A000 4518

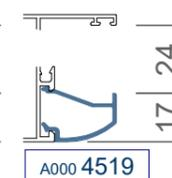

A000 4519

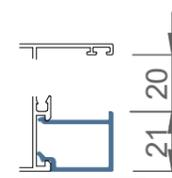

A000 4521

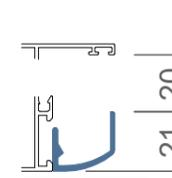

A000 4522

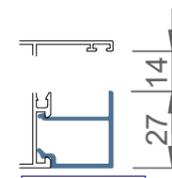

A000 4527

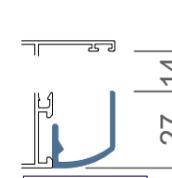

A000 4528

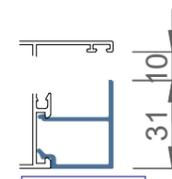

A000 4531

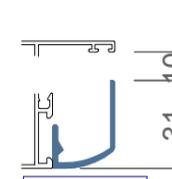

A000 4532

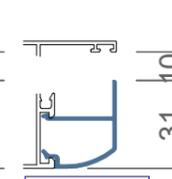

A000 4533



A000 2315

junta exterior (1mm)



A000 2351

junta exterior (2mm)



A000 2353

junta cuña (de 3 a 5mm)



A000 2355

junta cuña (de 5 a 7mm)



A000 2357

junta cuña (de 7 a 9mm)

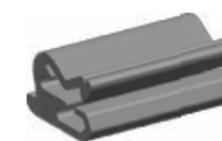

grapa junquillos elípticos

A000 2102

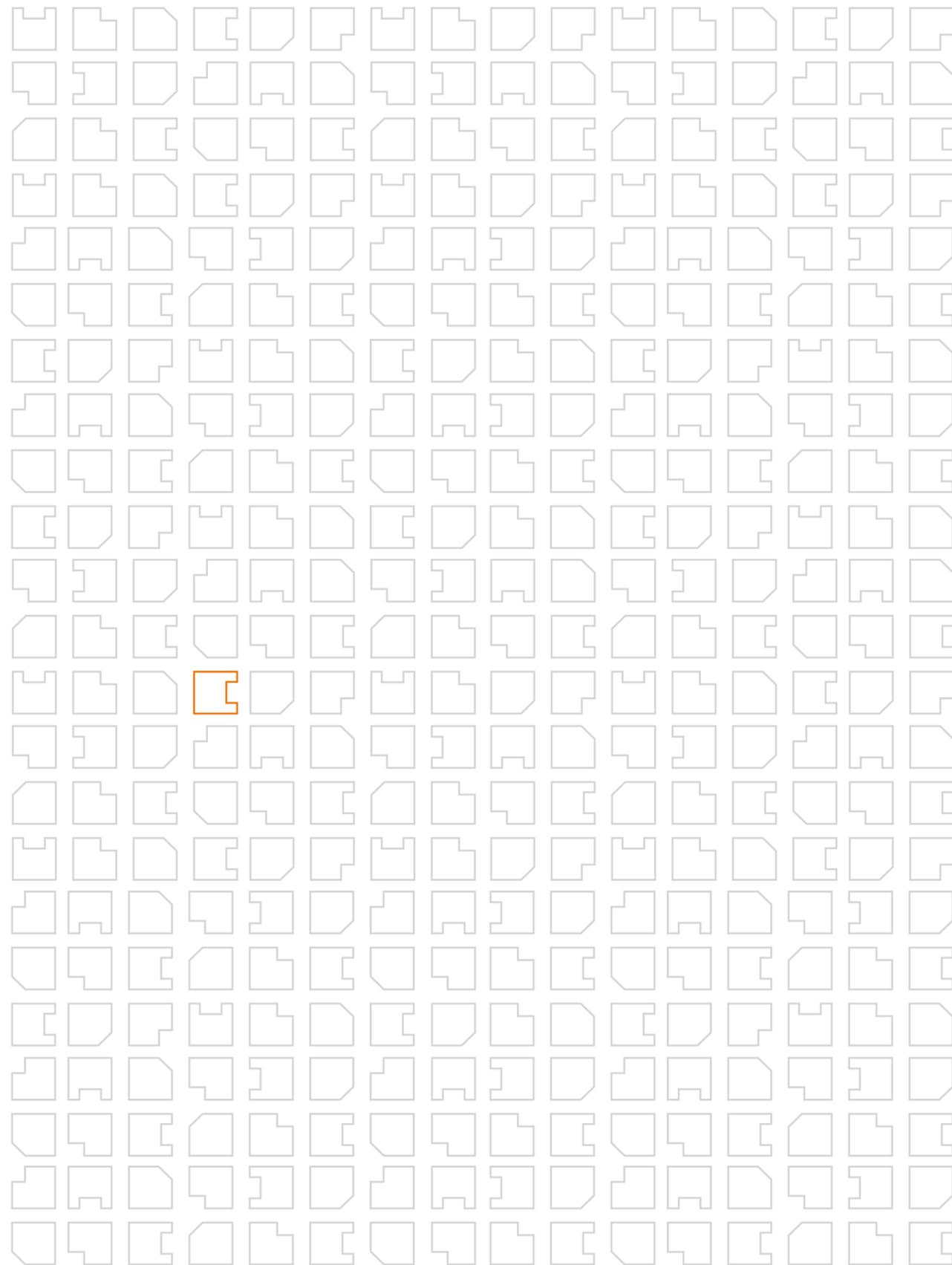

escuadra alineación alas exteriores



A000 2134

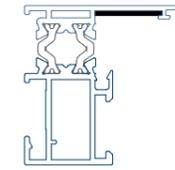

escuadra alineación ala cremona



A000 2132

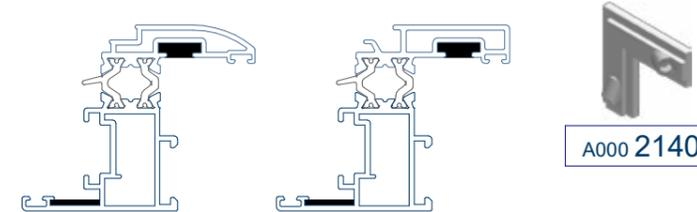

A000 2140

escuadra alineación multiuso



A000 2142

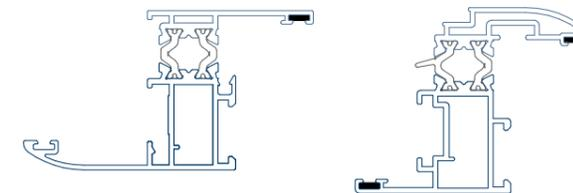

escuadra alineación multiuso
(alojamiento juntas)



A000 2143

colocación posible
con la junta

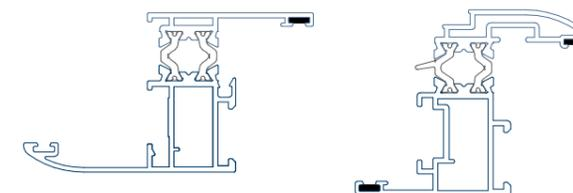

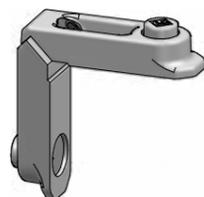

A000 2110
escuadra base

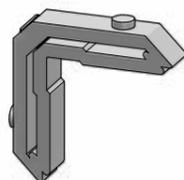

AR52 2118
escuadra exterior

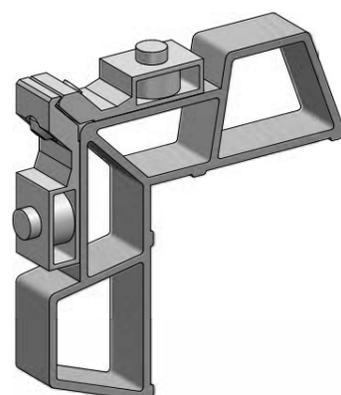

A000 2113
escuadra hoja p.

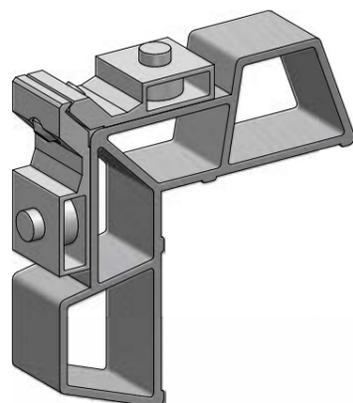

A000 2114
escuadra hoja p.



A000 2120
unión travesaño

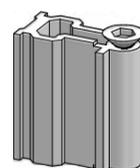

A000 2122
unión montante

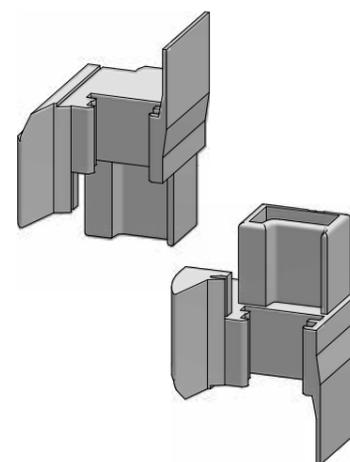

A000 2340
juego base tapas inv CE

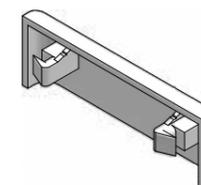

A000 2301
tapón deflector



A000 2310
junta central

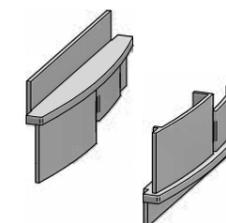

A000 2341
juegos tapas ext inv curvo

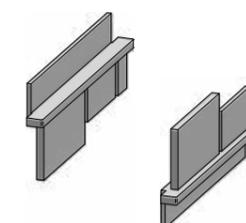

A000 2342
juego tapas ext inv recto



A000 2320
junta int hoja

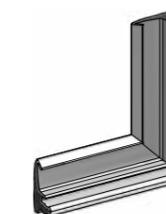

A000 2309
ángulo junta central

Para accesorios de Maniobra consultar catálogo específico

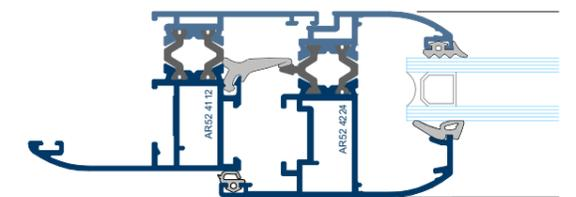
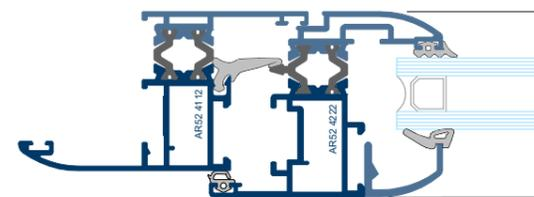
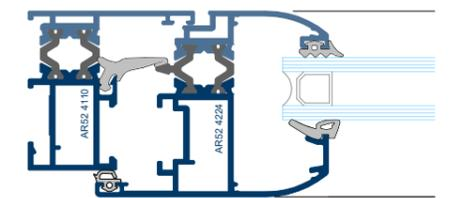
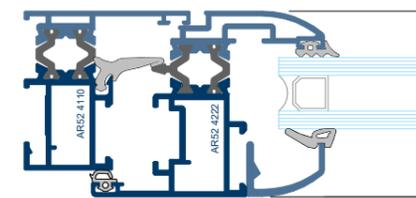
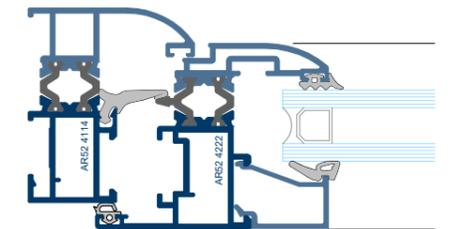
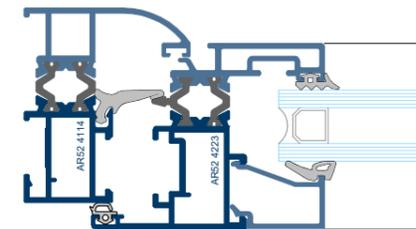
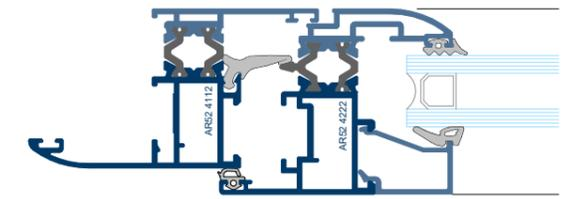
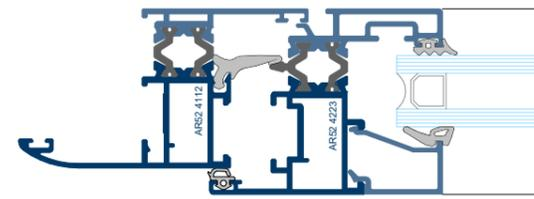
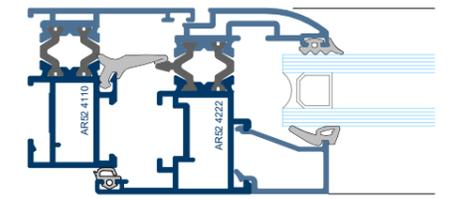
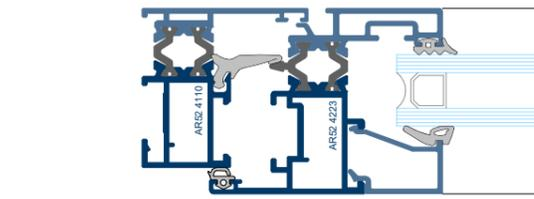
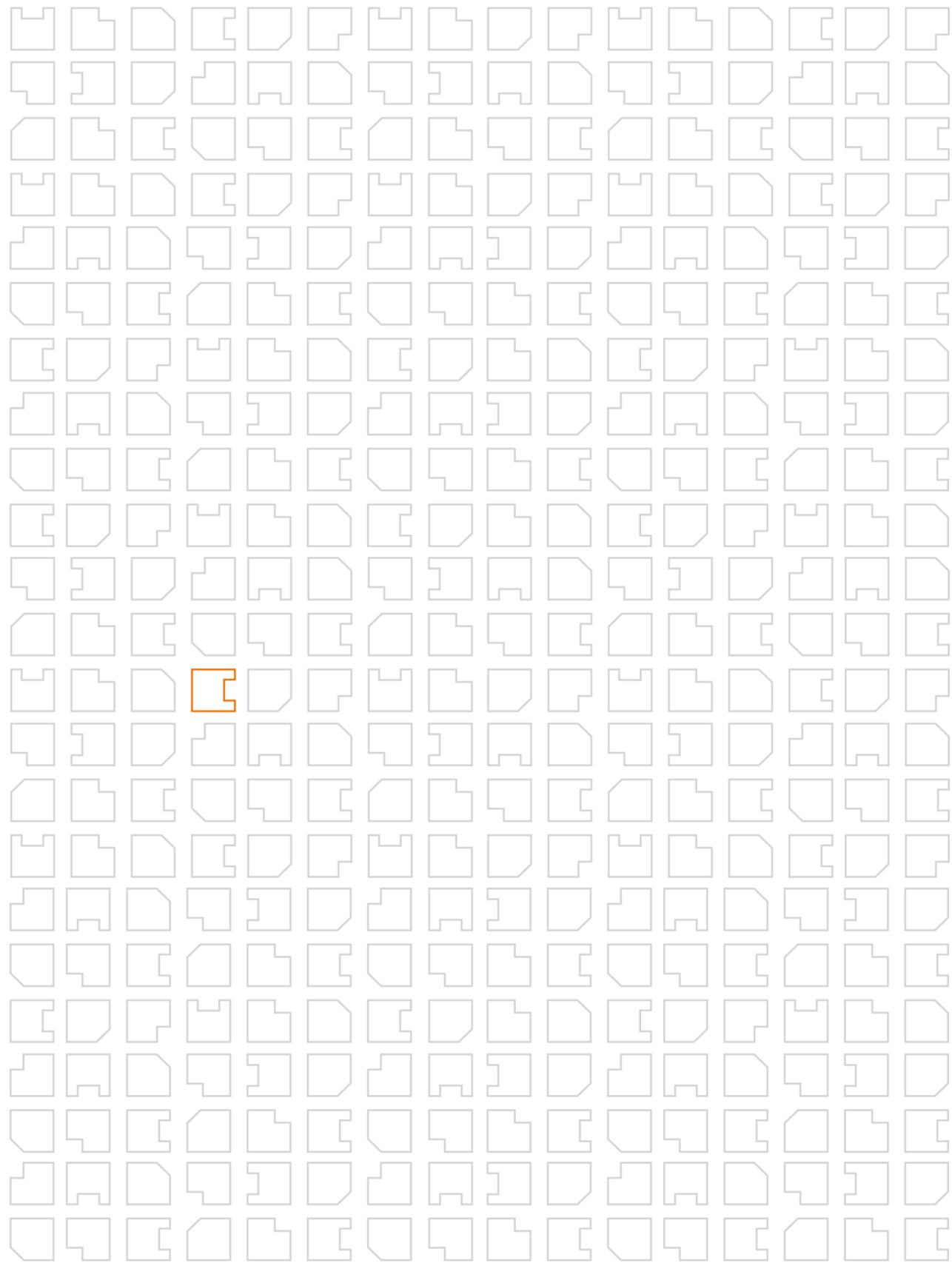

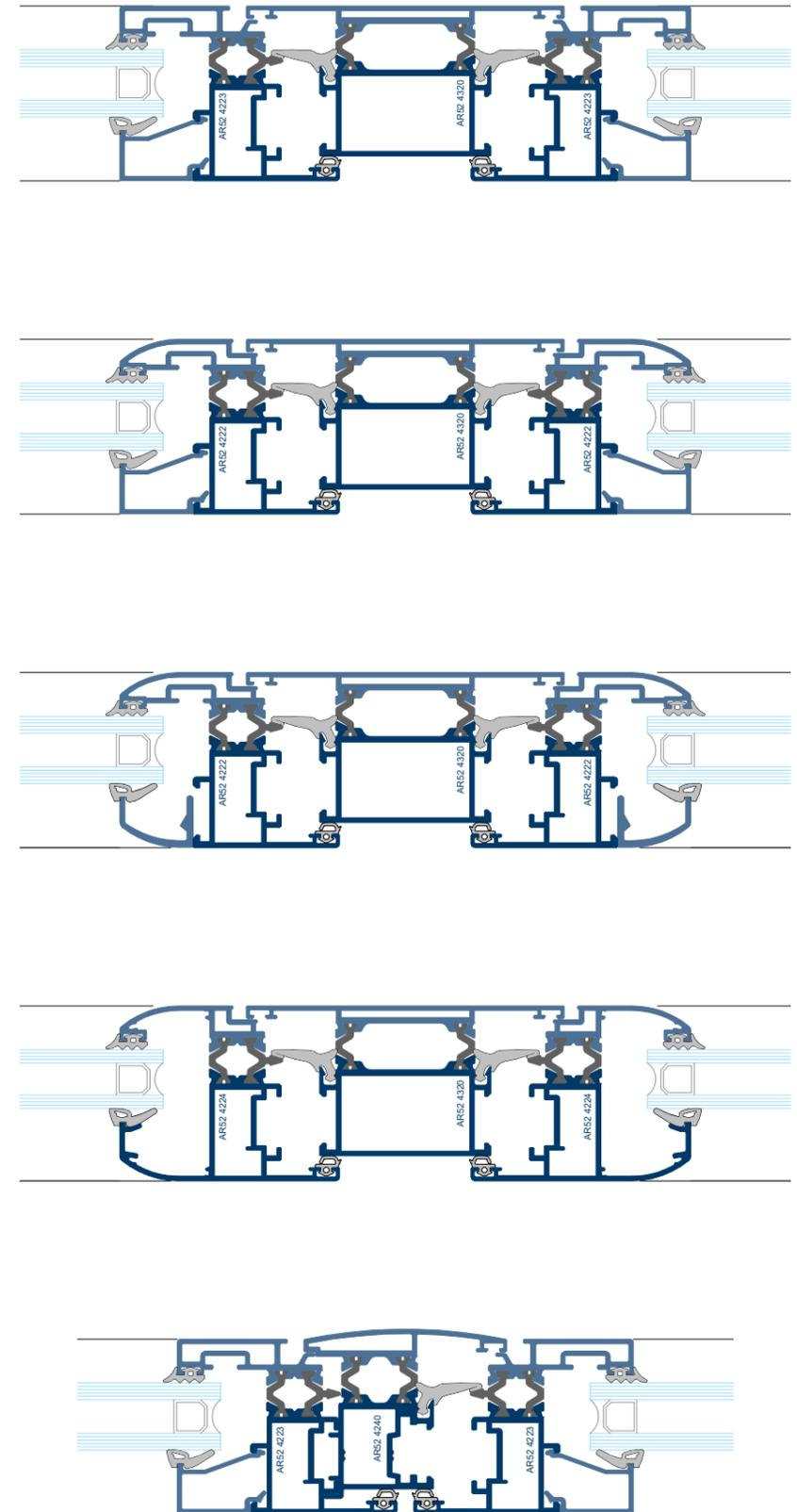
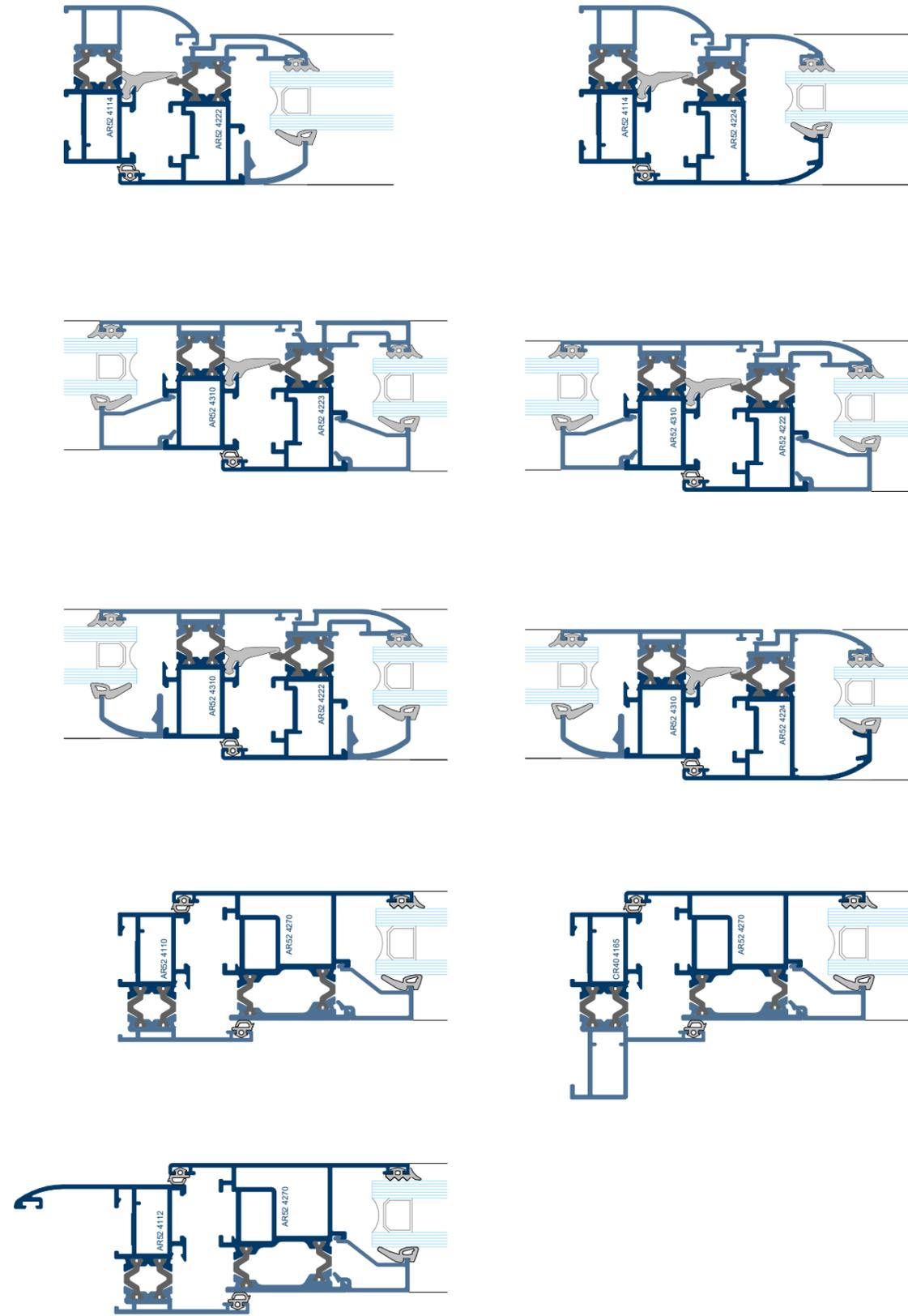

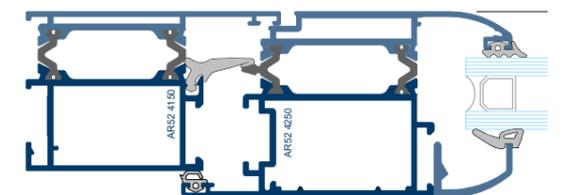
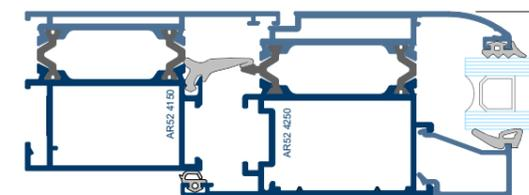
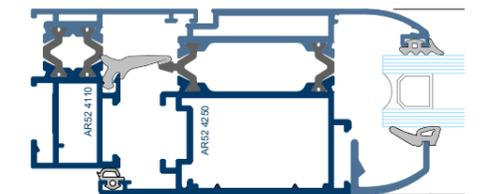
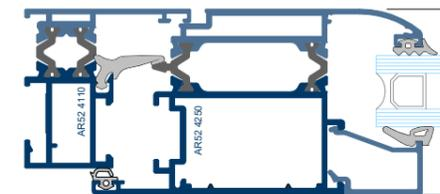
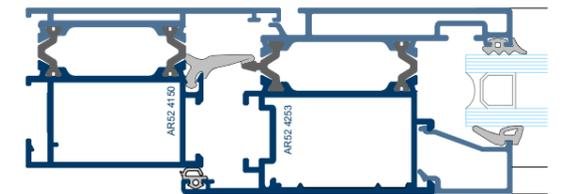
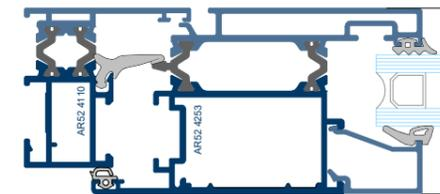
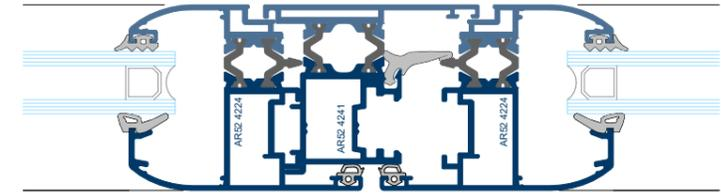
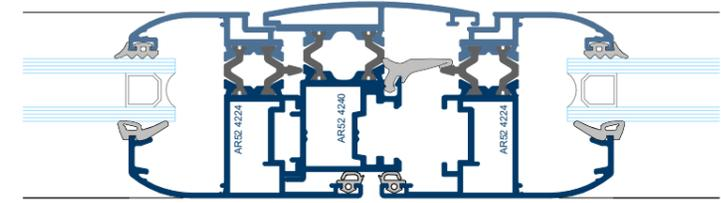
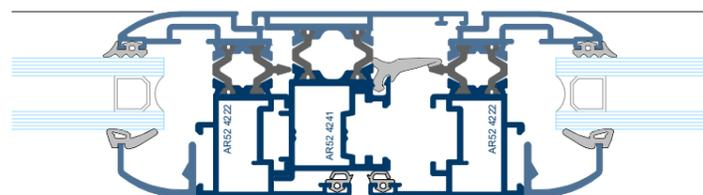
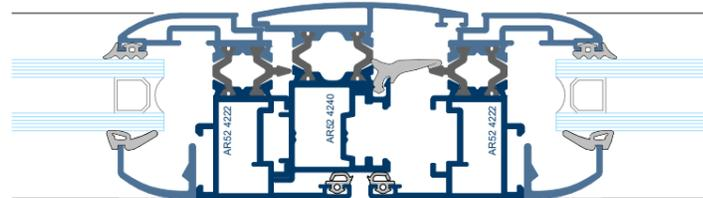
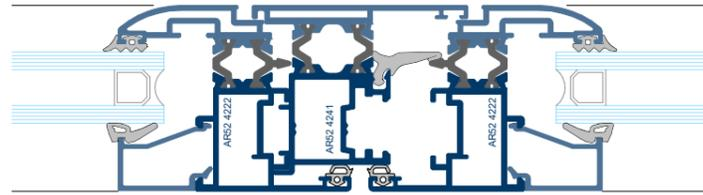
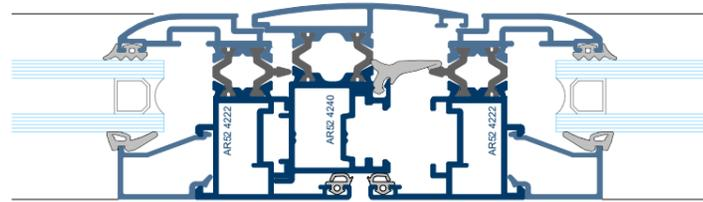
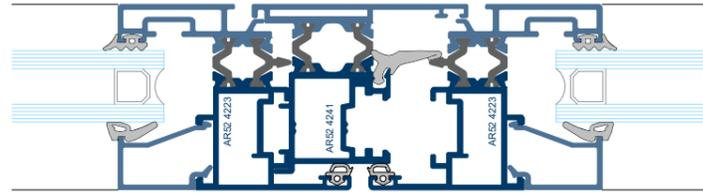

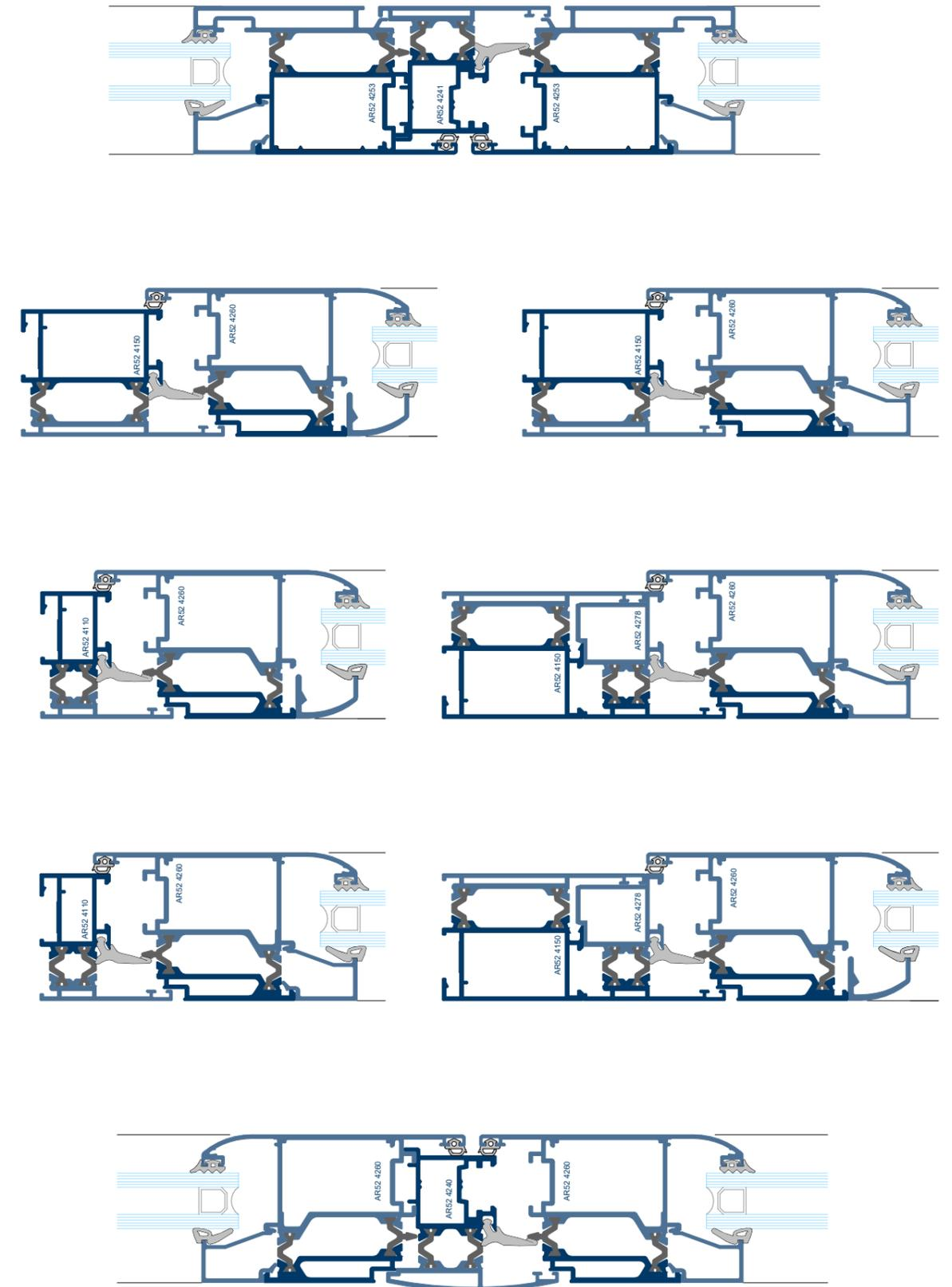
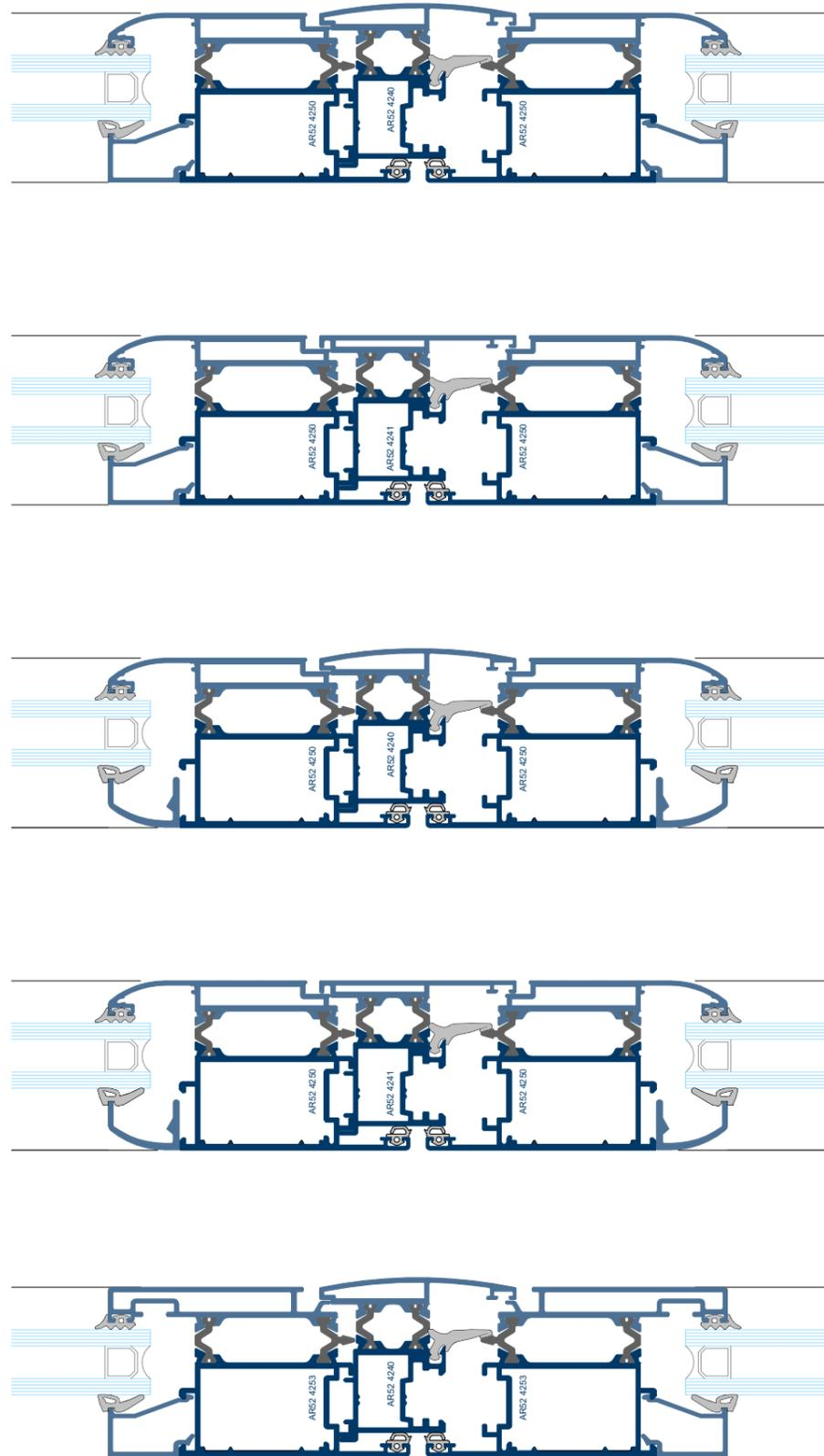

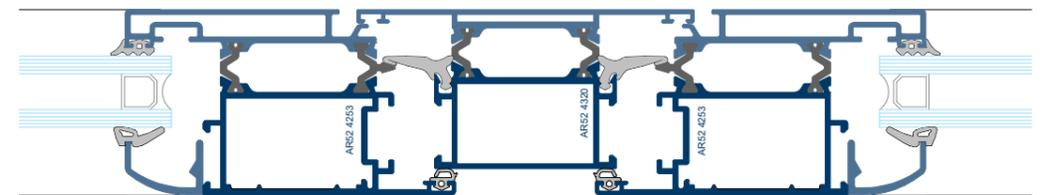
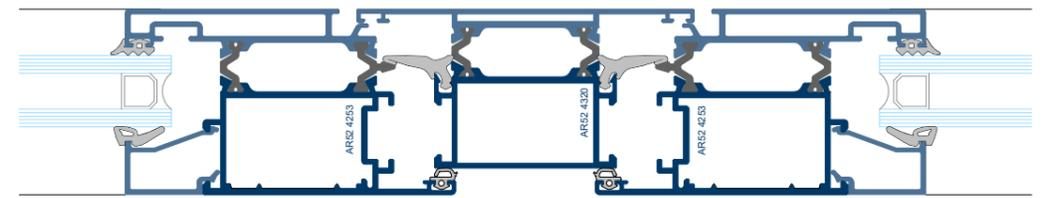
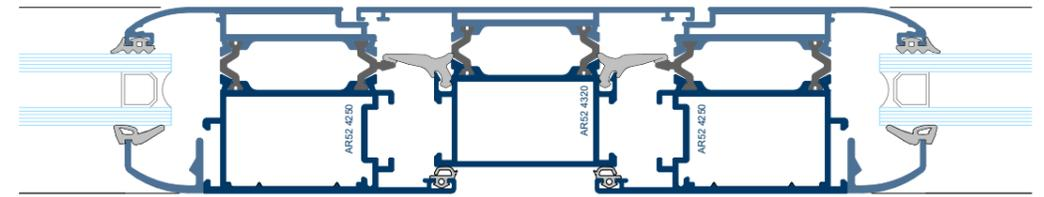
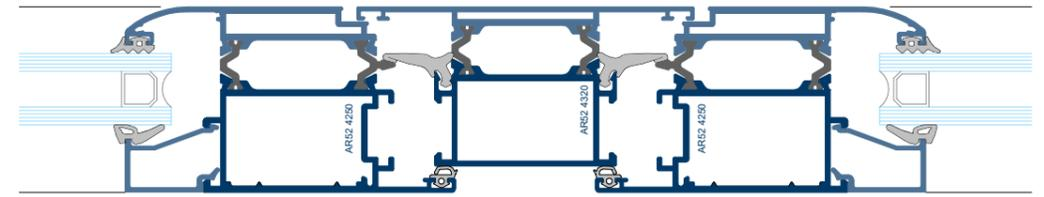
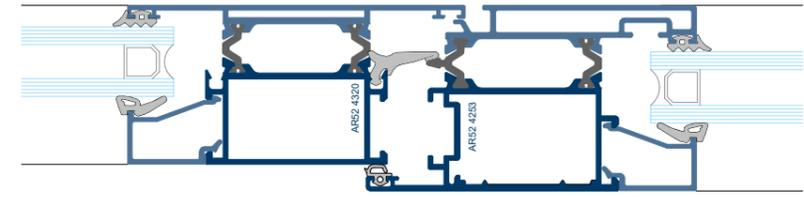
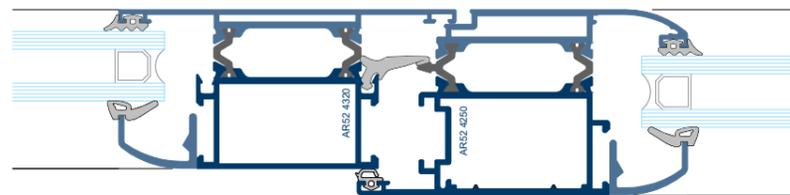
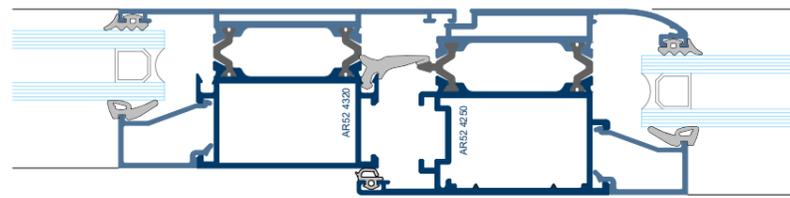
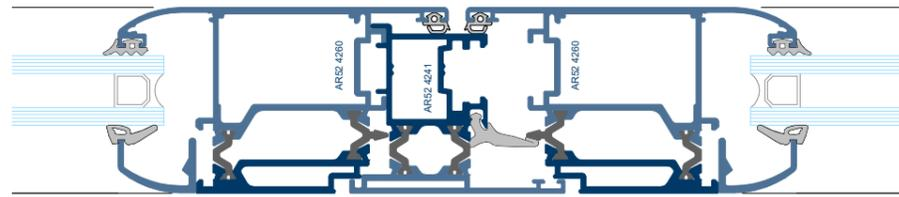
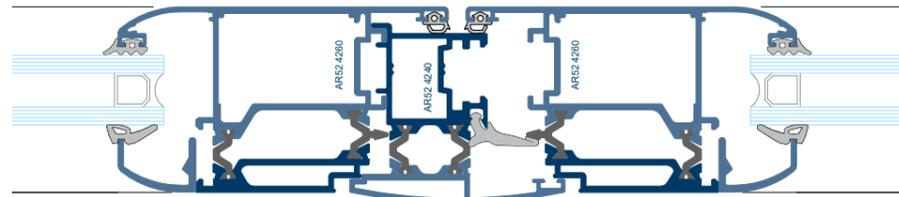
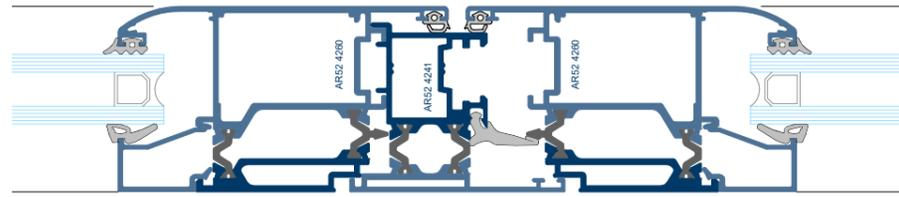

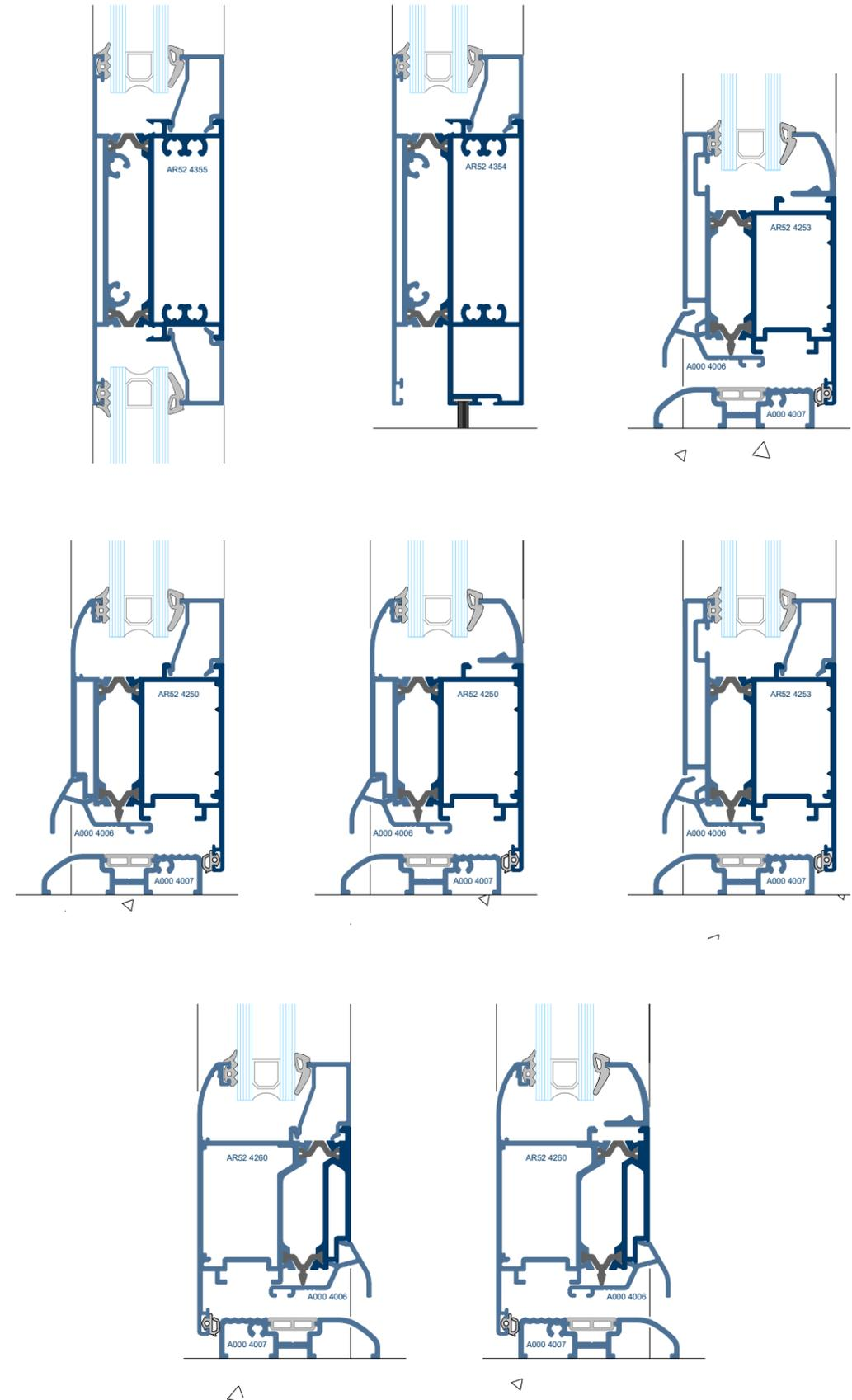
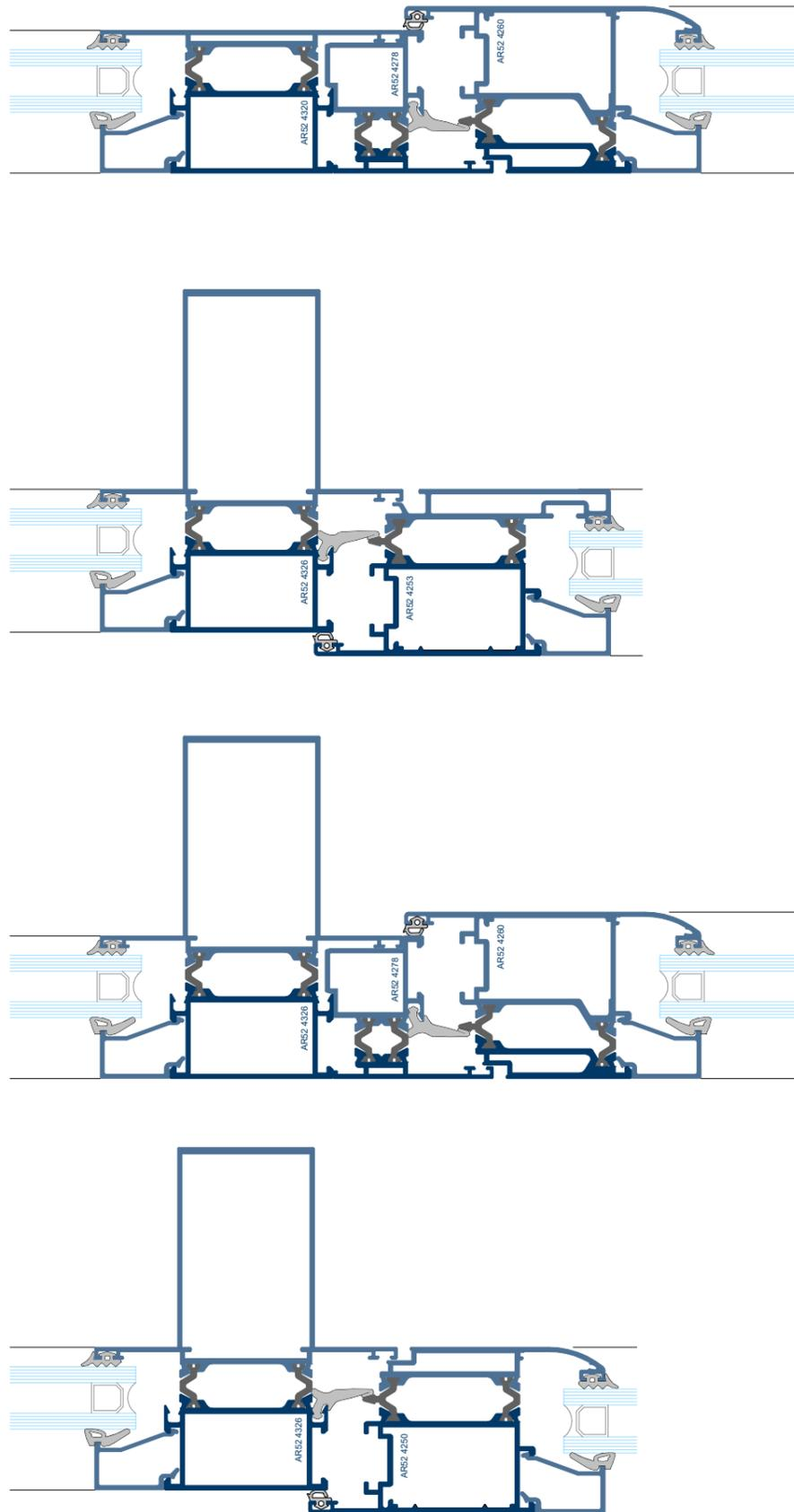

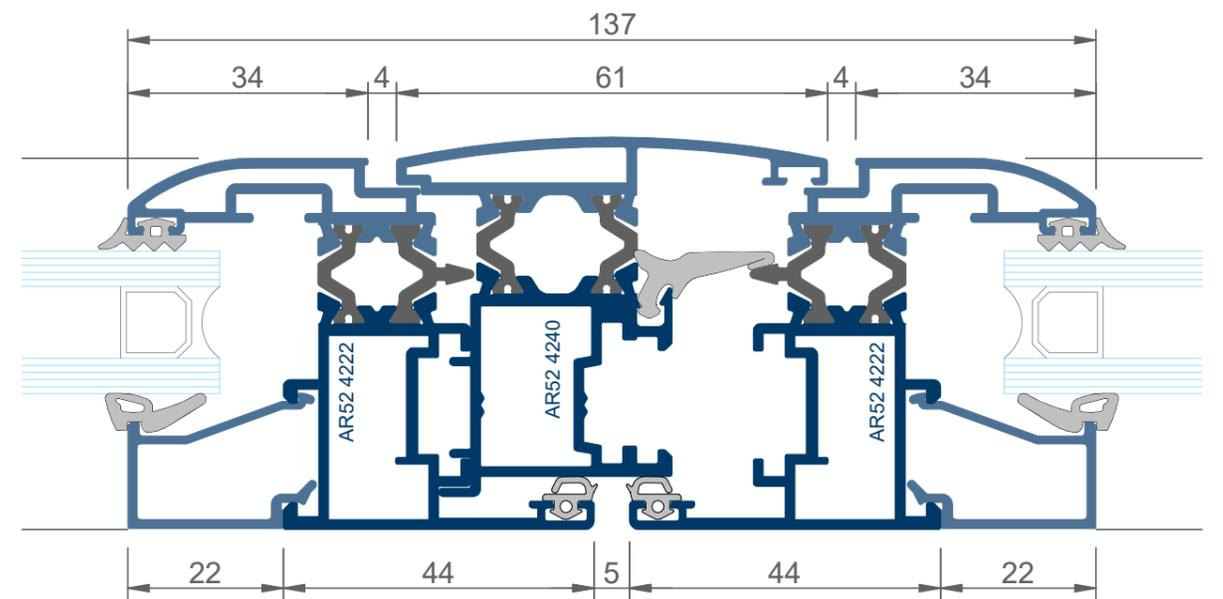
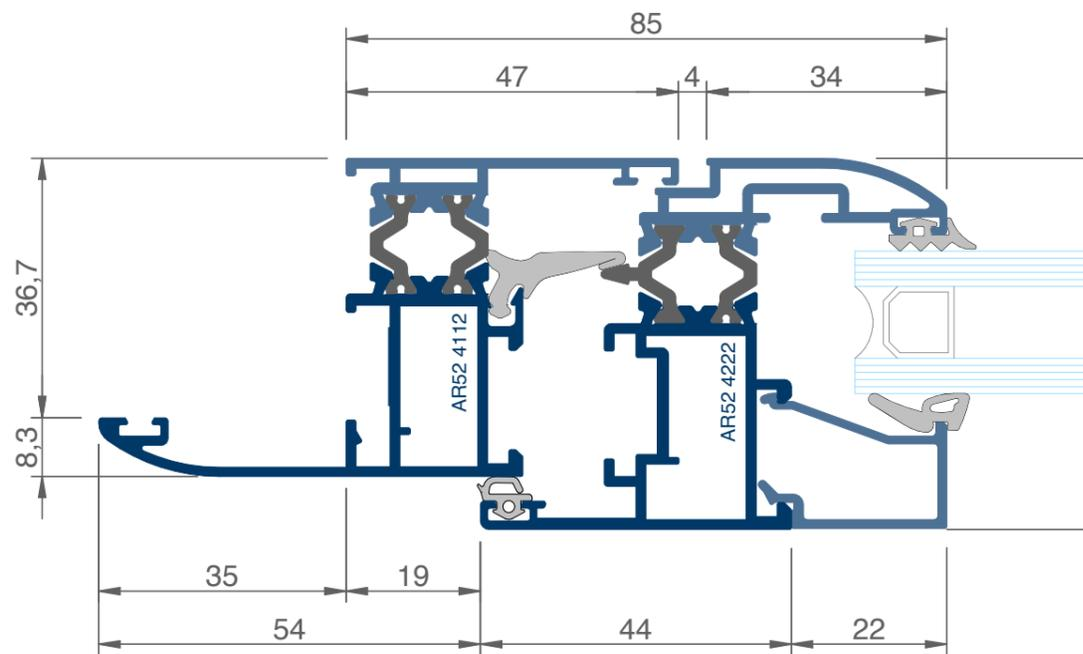
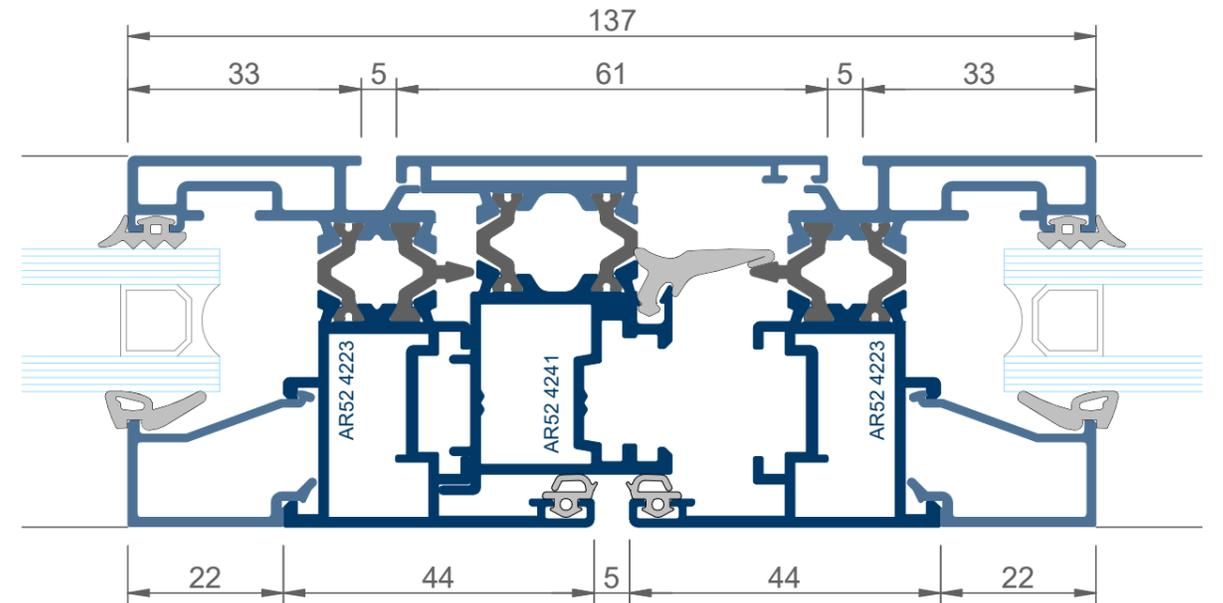
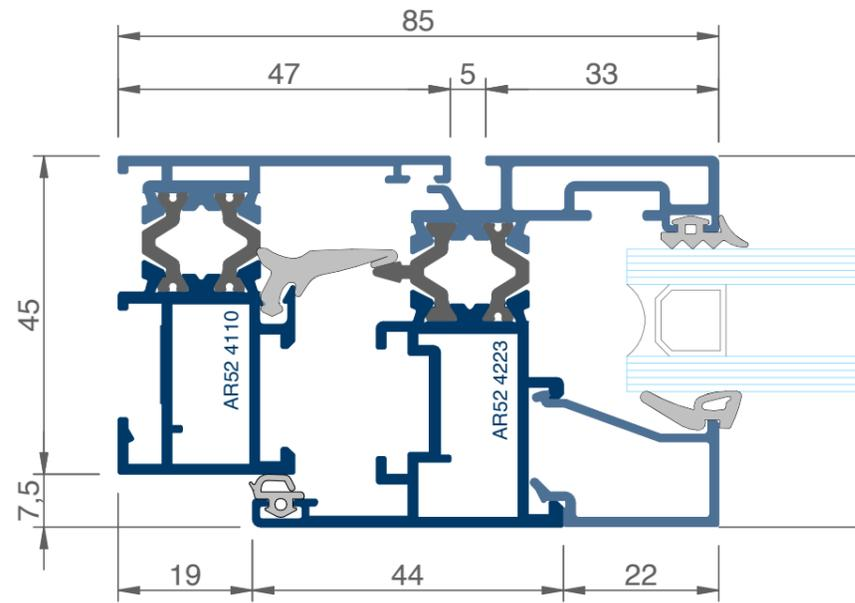

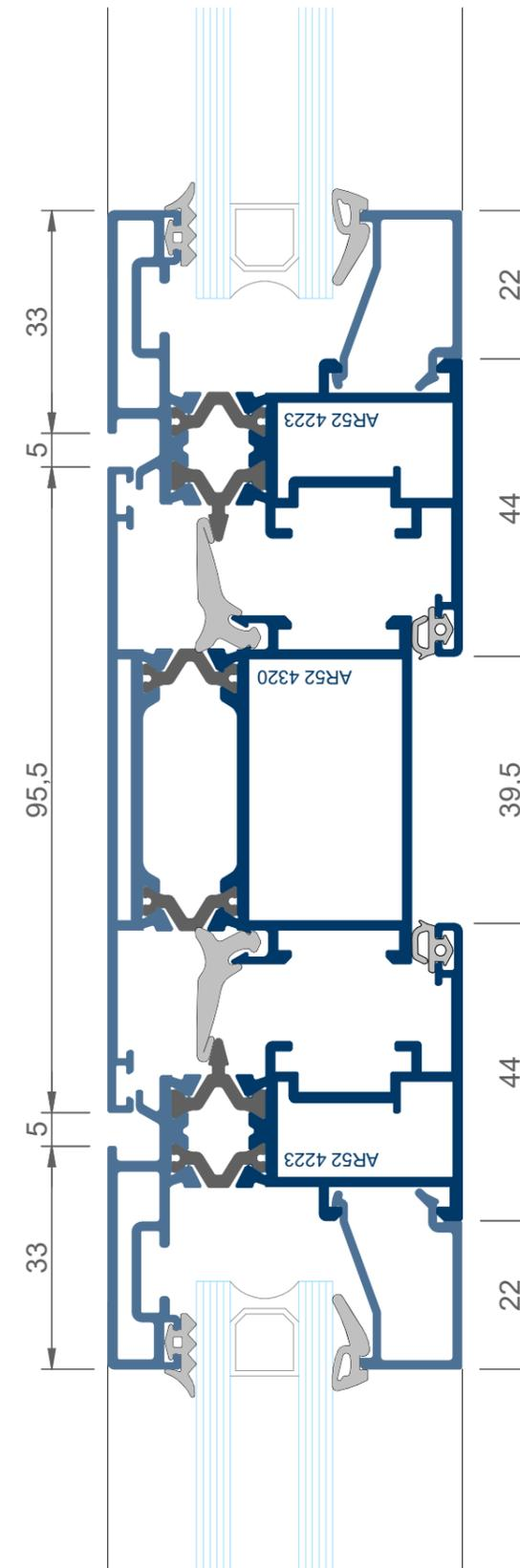
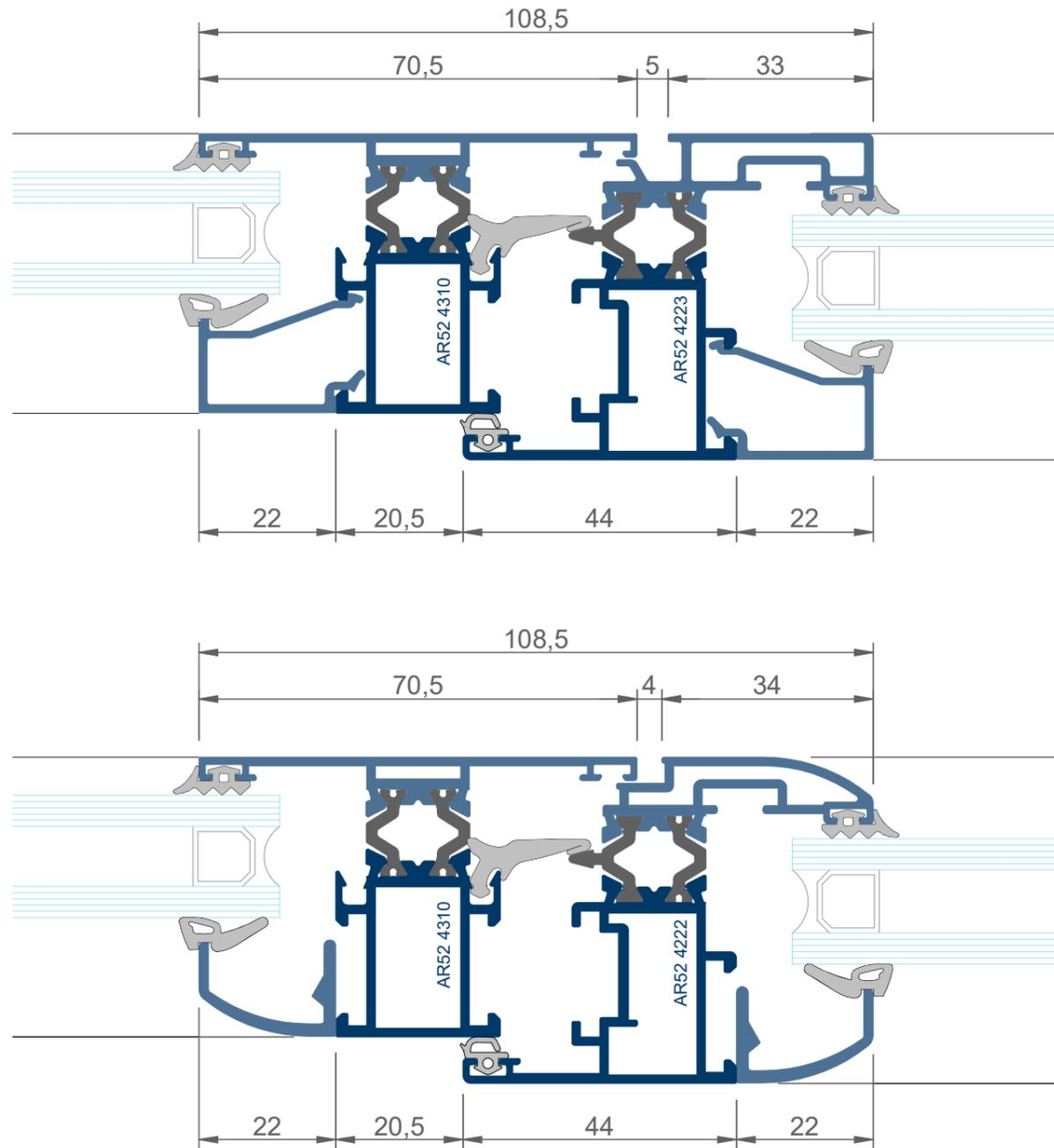

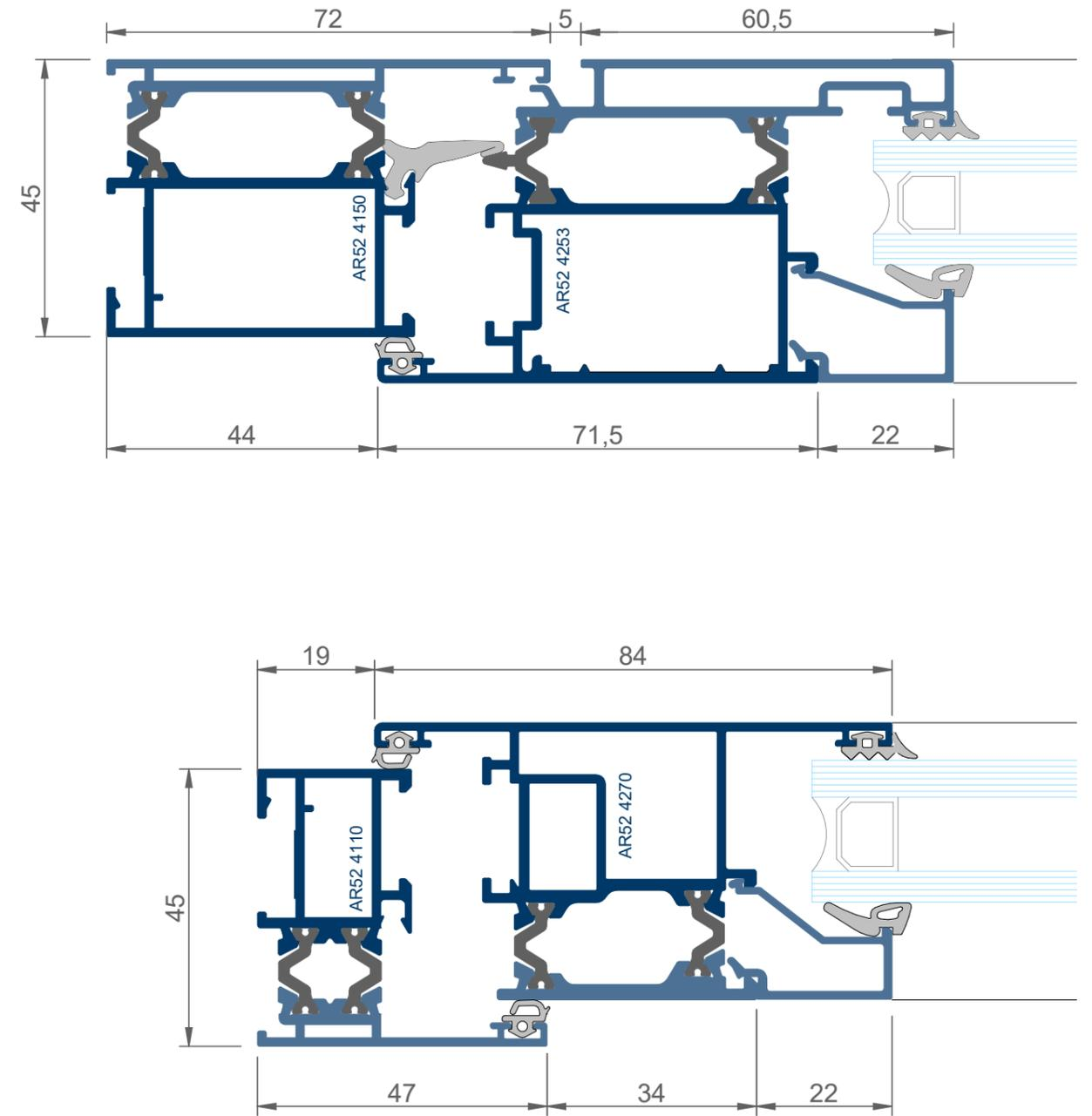
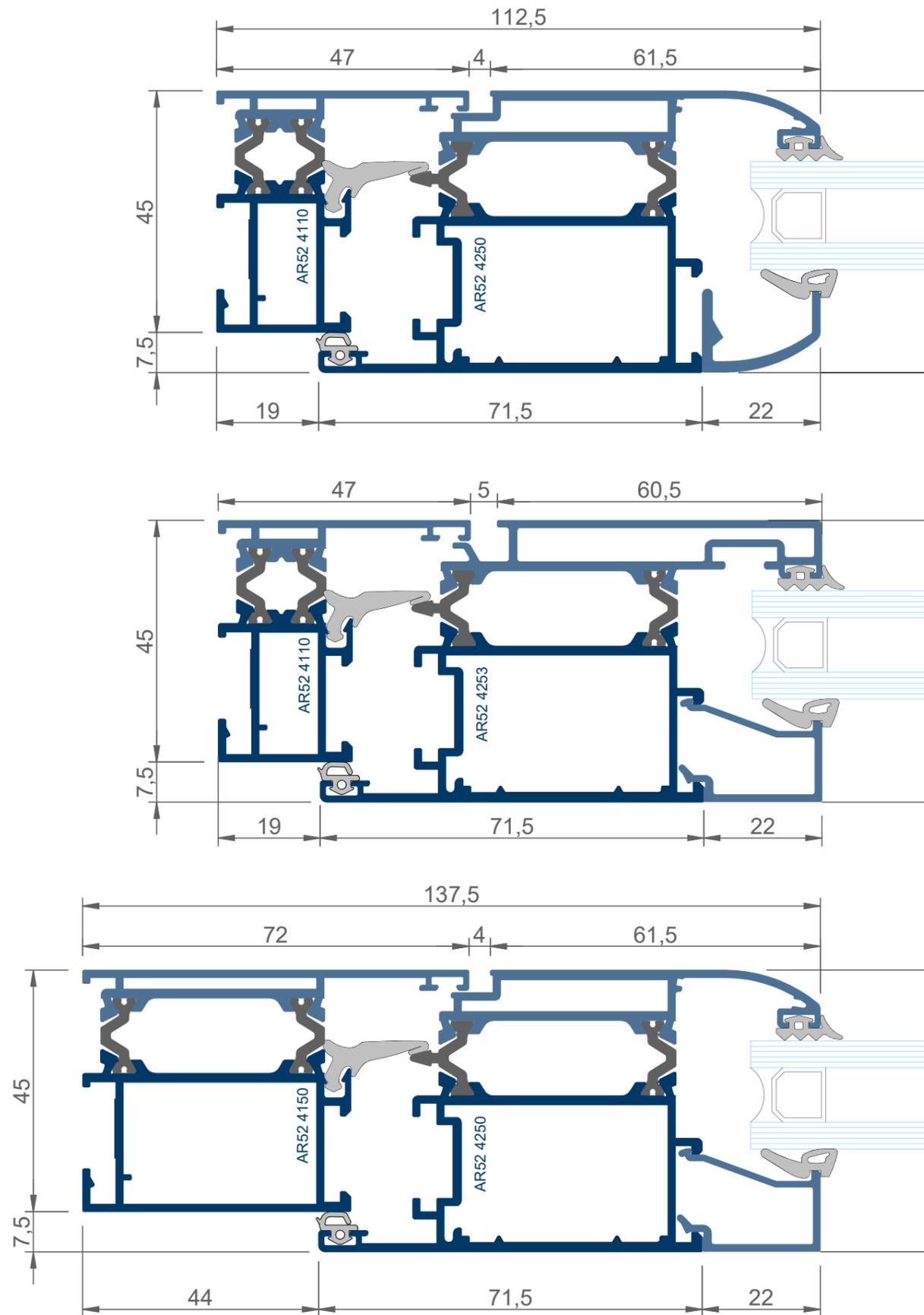

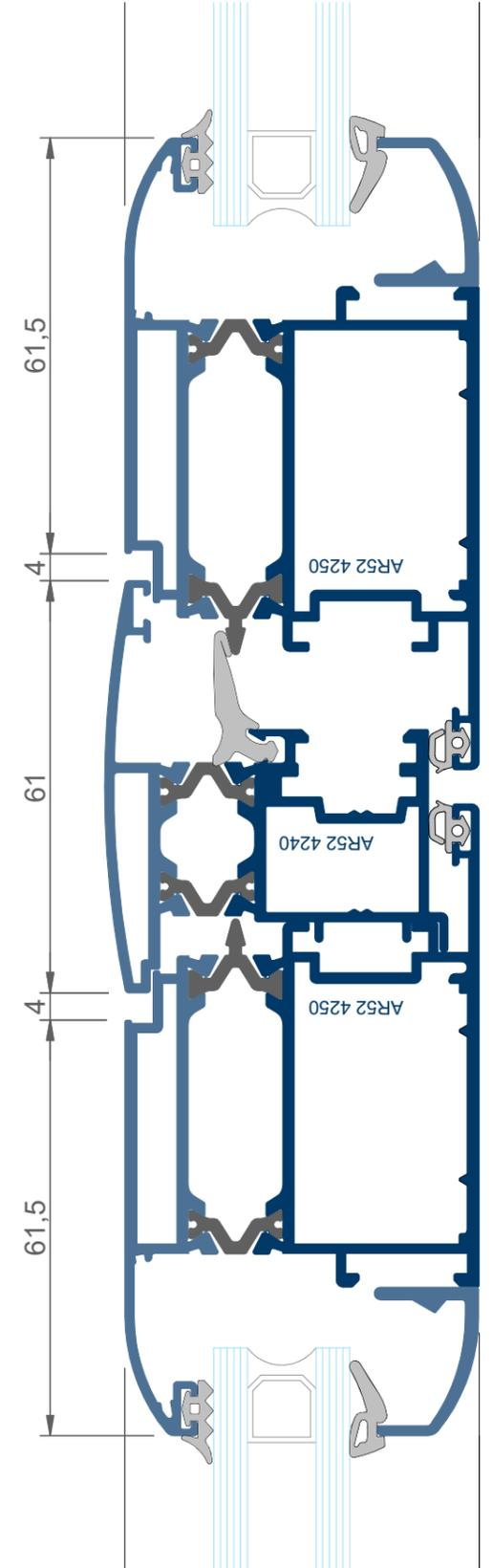
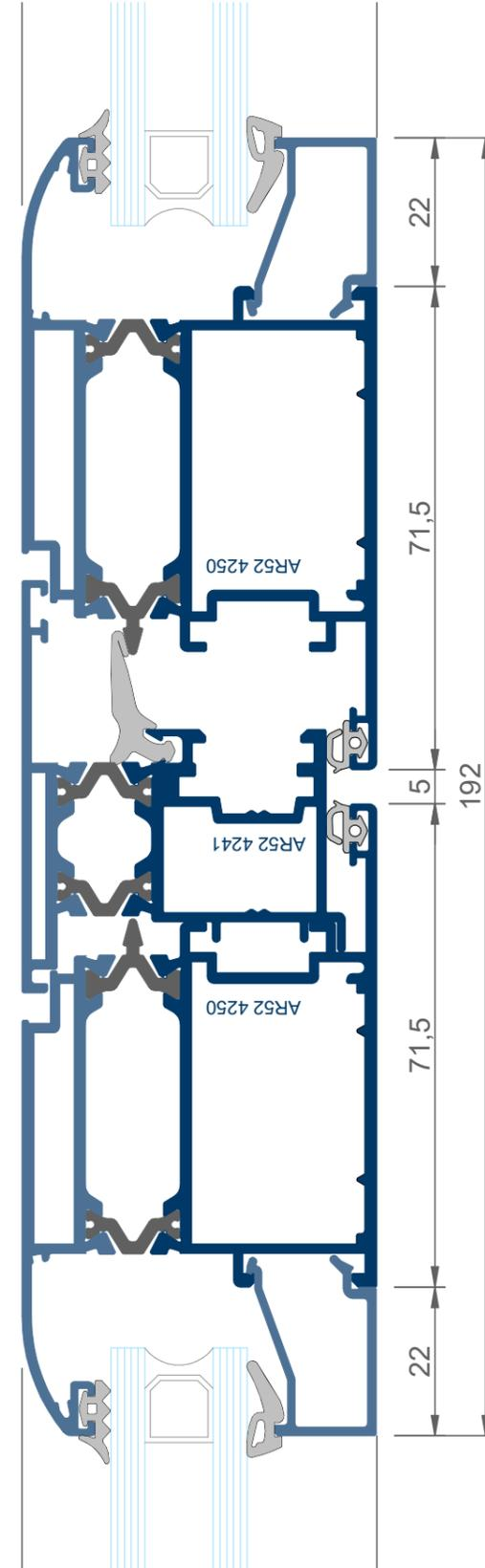
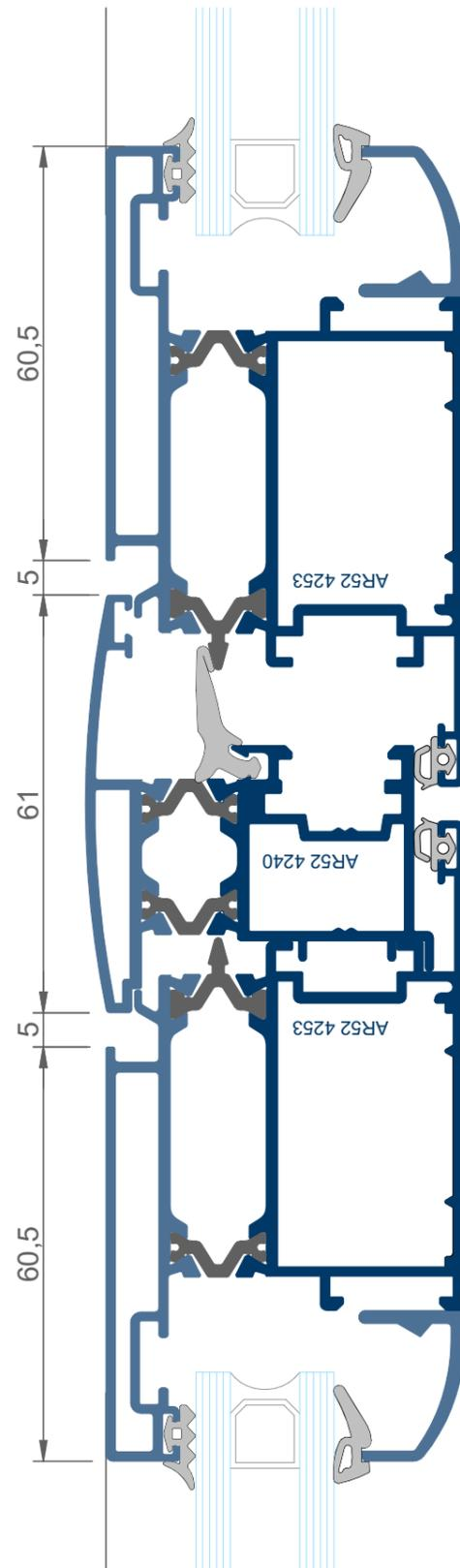
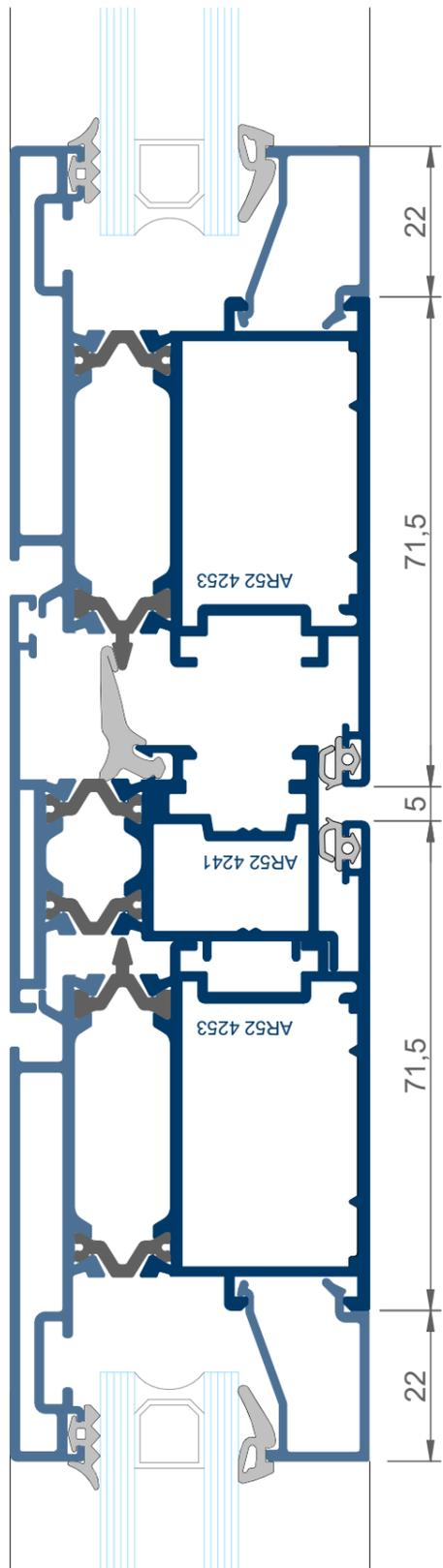

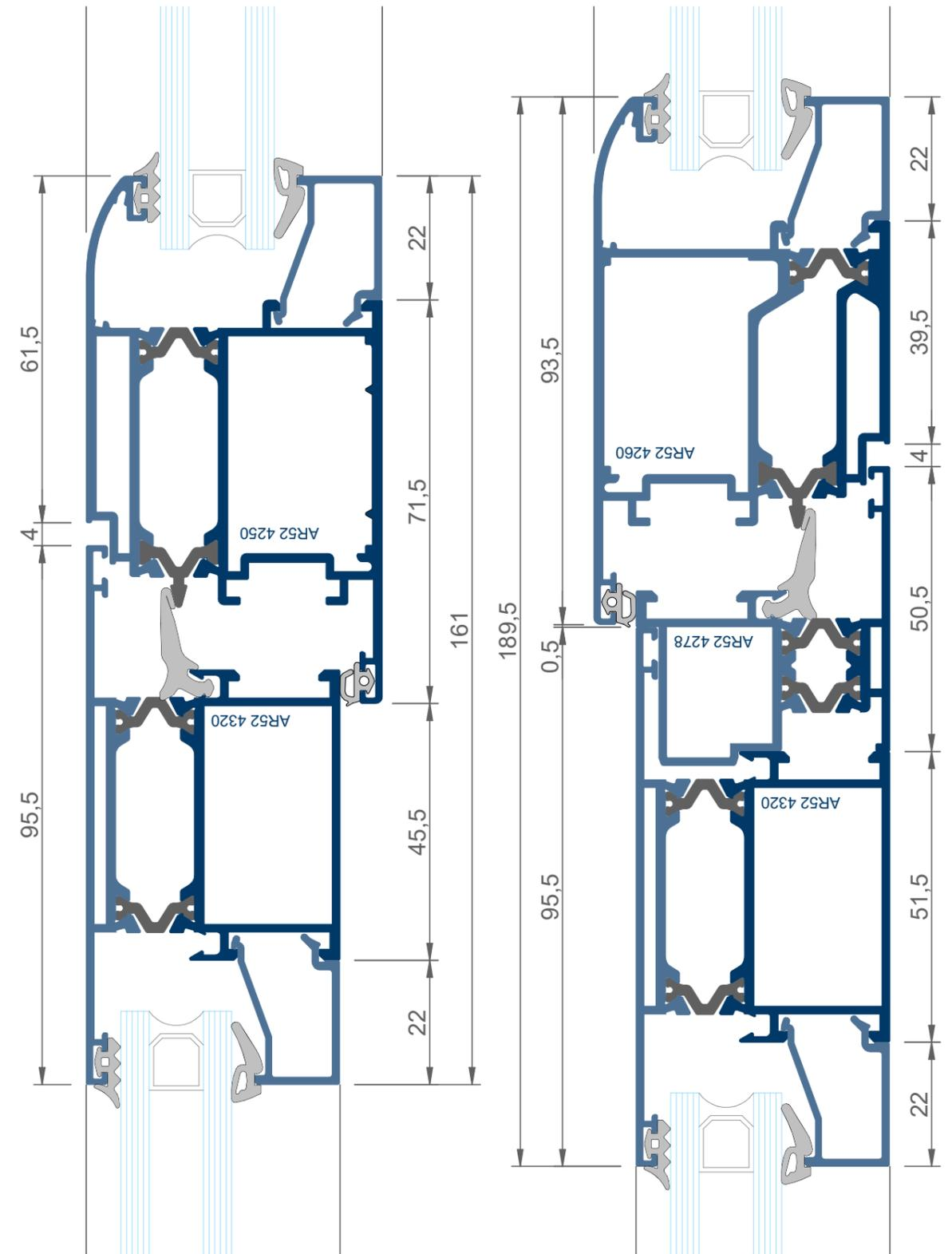
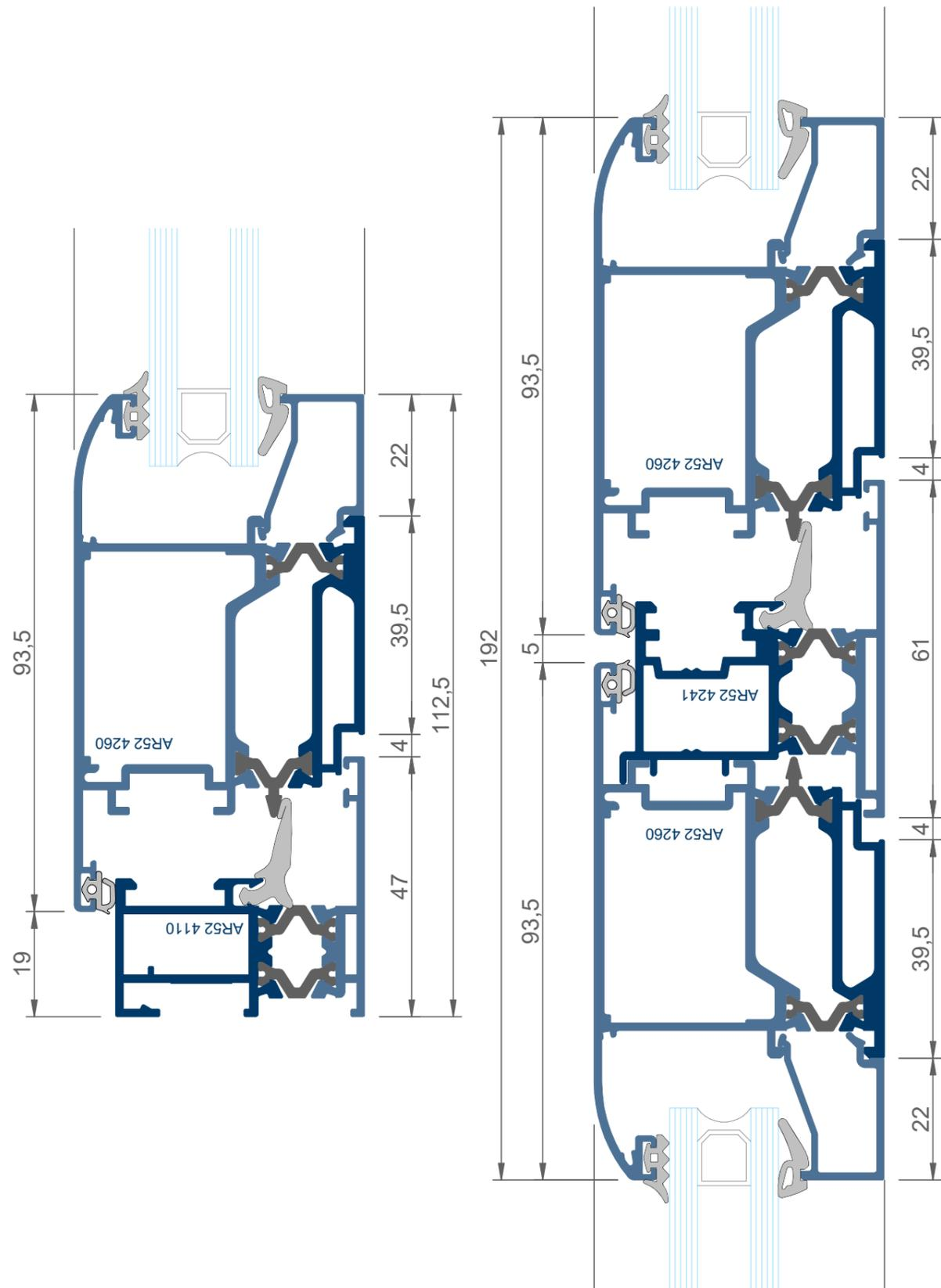

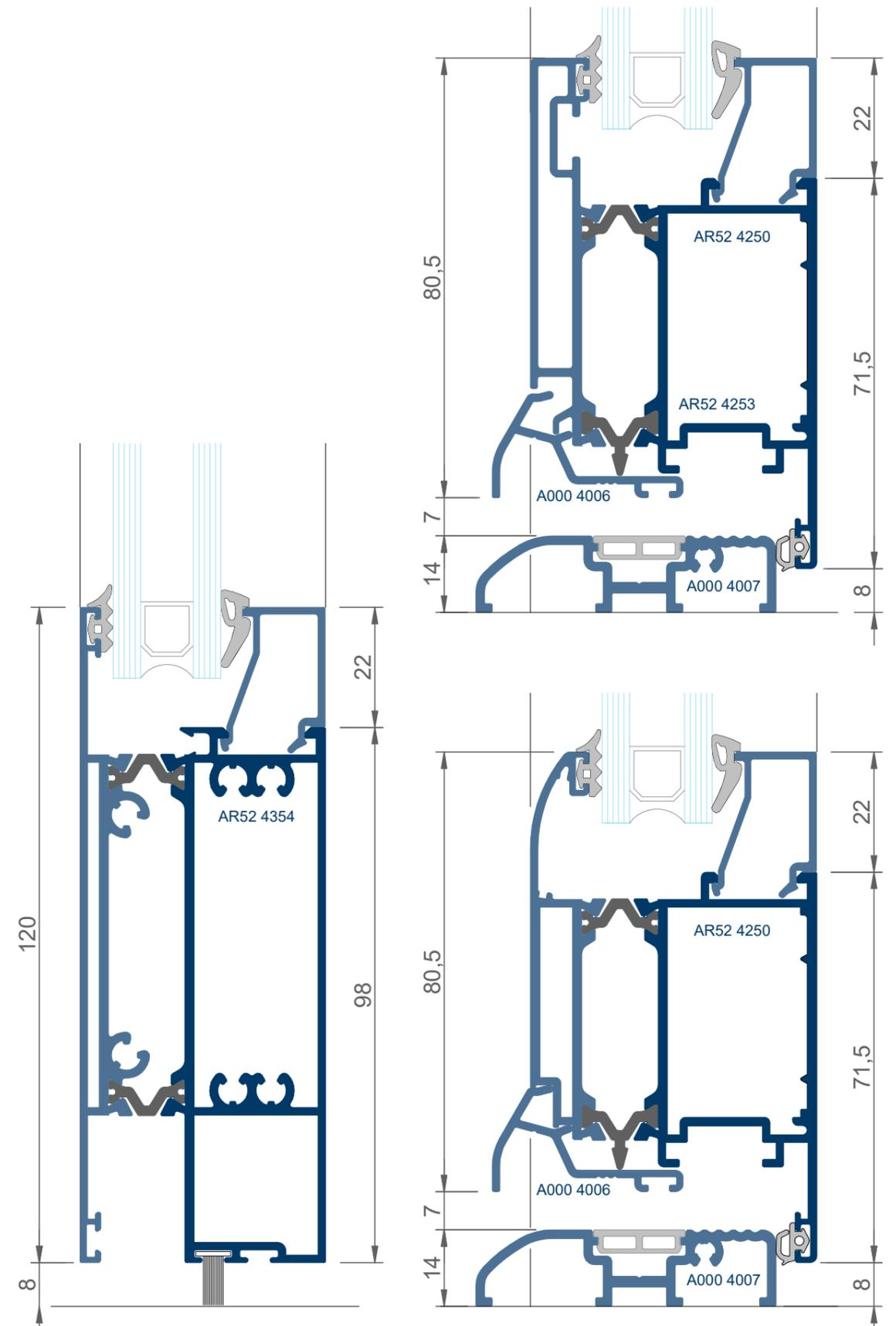
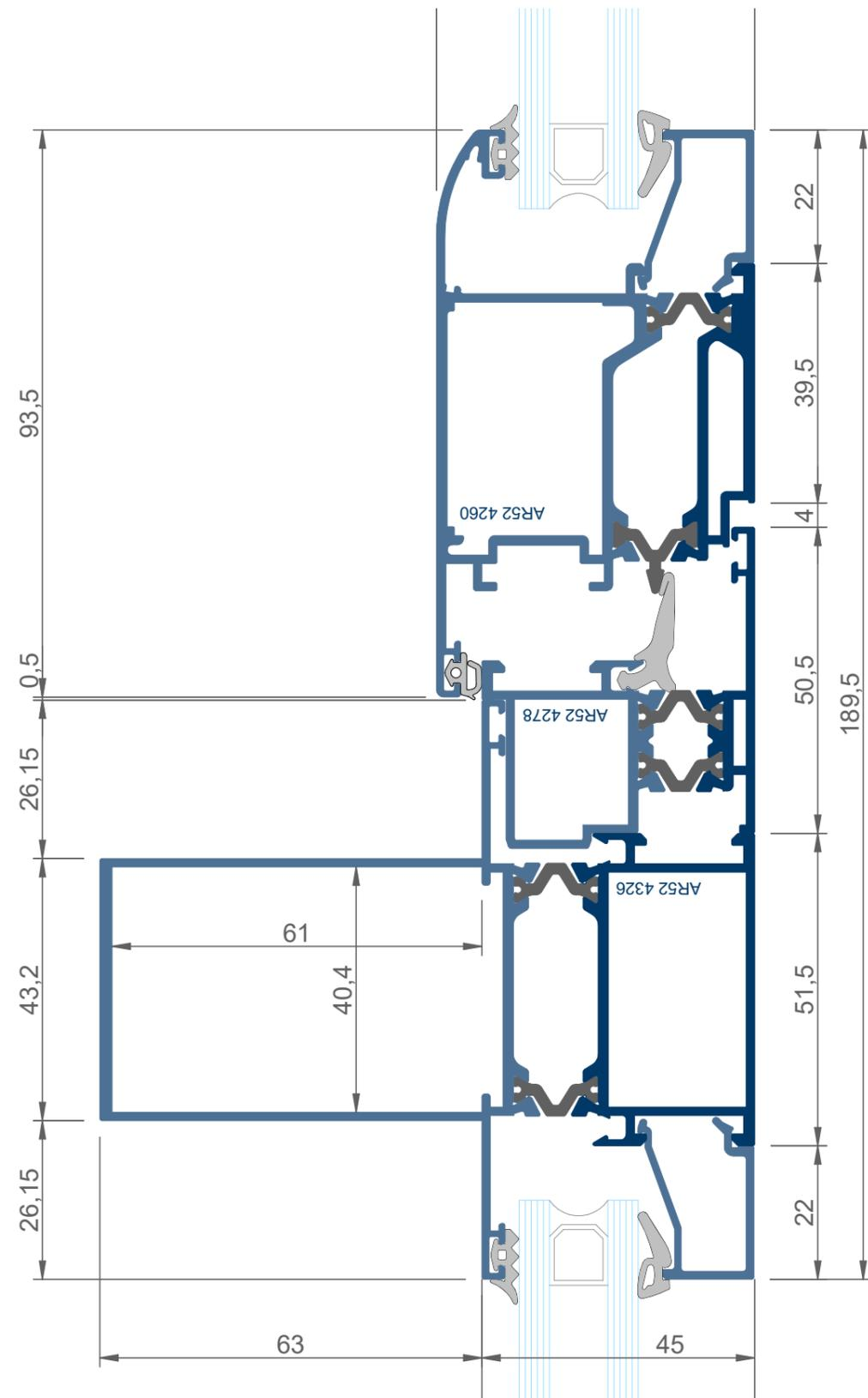

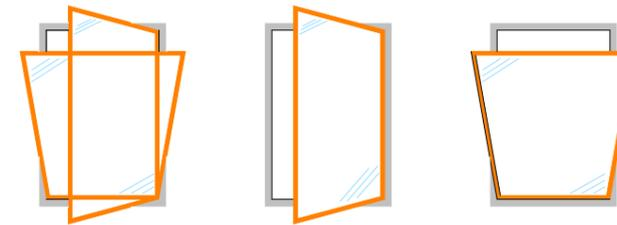
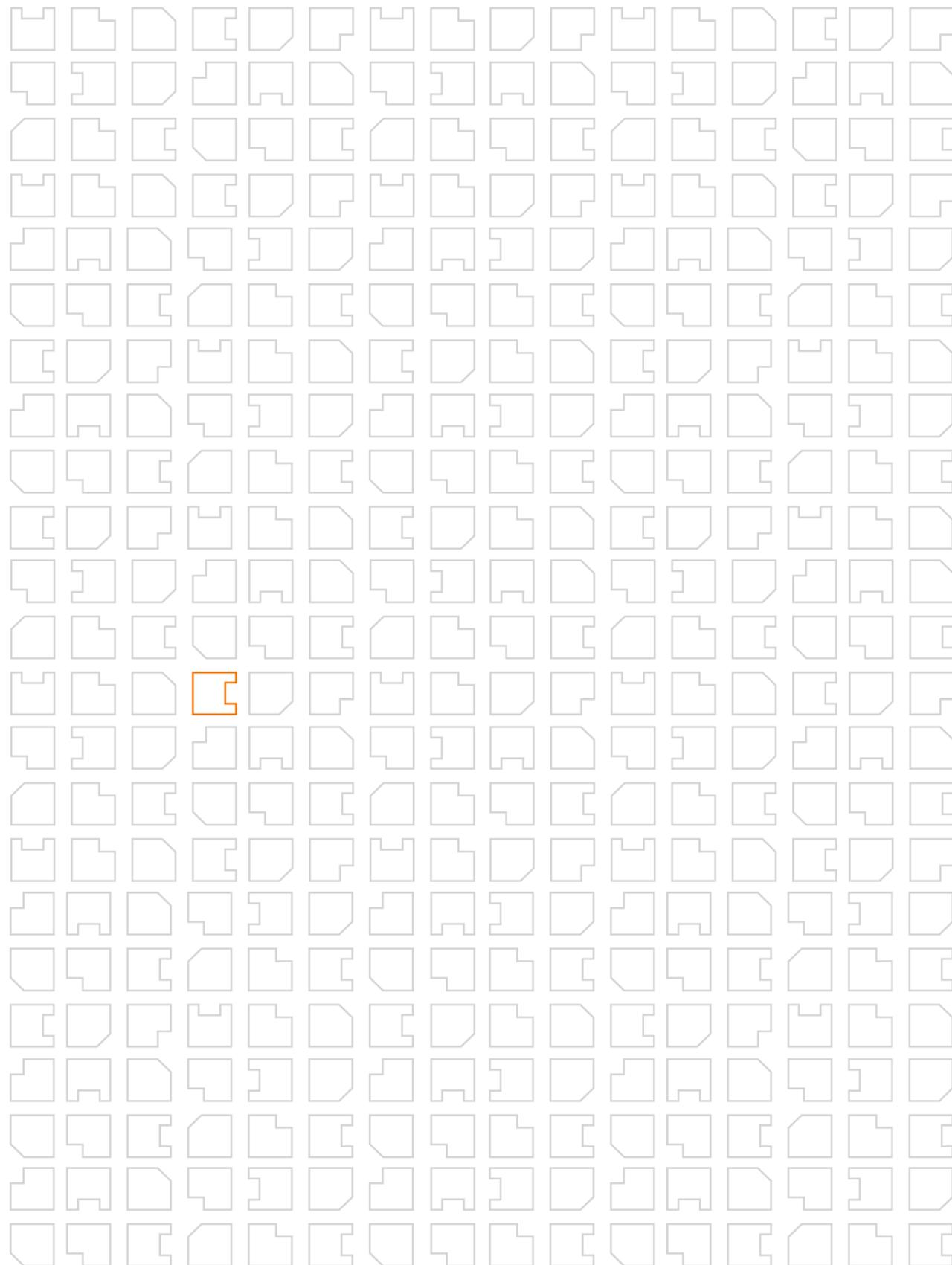

FORMULAS DE CORTE				
		UDS	FORMULA	FORMA
marco horizontal	AR52.4110	2	B	\---/
marco vertical	AR52.4110	2	H	\---/
hoja horizontal	AR52.4223	2	B-39	\---/
hoja vertical	AR52.4223	2	H-39	\---/
junquillo recto horizontal	A000.XXXX	2	B-126	---
junquillo eliptico horizontal	A000.XXXX	2	B-126	\---/
junquillo recto vertical	A000.XXXX	2	H-170	---
junquillo eliptico vertical	A000.XXXX	2	H-126	\---/
vidrio		1	B-146 x H-146	

ACCESORIOS		
		UDS
escuadra	A000.2110	8
escuadra alineacion int hoja	A000.2132	4
deflector desagüe	A000.2301	2
junta central	A000.2310	2B+2H
junta int hoja	A000.2320	2B+2H
junta ext acristalamiento	A000.2351	2B+2H
junta cuña int	A000.XXXX	2B+2H

accesorios de maniobra no indicados (ver catalogo de maniobra)

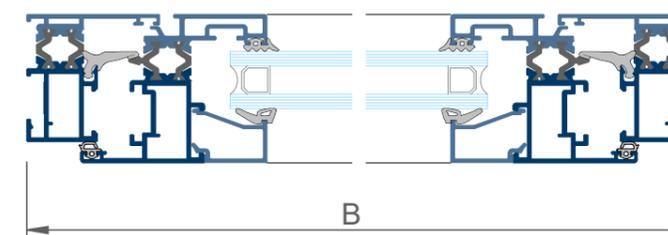
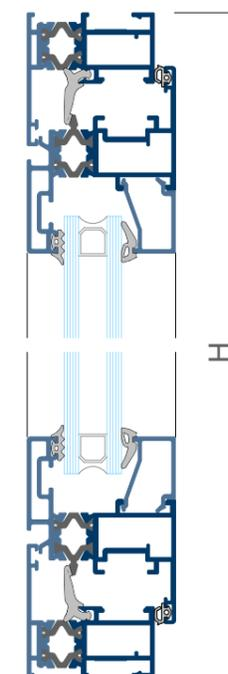

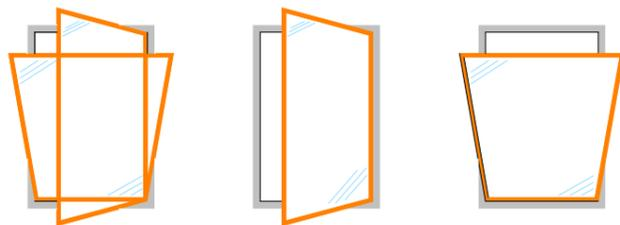

FORMULAS DE CORTE			
	UDS	FORMULA	FORMA
marco horizontal	AR52.4112	2	B+70 \---/
marco vertical	AR52.4112	2	H+70 \---/
hoja horizontal	AR52.4223	2	B-39 \---/
hoja vertical	AR52.4223	2	H-39 \---/
junquillo recto horizontal	A000.XXXX	2	B-126 ---
junquillo eliptico horizontal	A000.XXXX	2	B-126 \---/
junquillo recto vertical	A000.XXXX	2	H-170 ---
junquillo eliptico vertical	A000.XXXX	2	H-126 \---/
vidrio	1	B-146 x H-146	

ACCESORIOS		
	UDS	
escuadra	A000.2110	8
escuadra alineacion int hoja	A000.2132	4
deflector desagüe	A000.2301	2
junta central	A000.2310	2B+2H
junta int hoja	A000.2320	2B+2H
junta ext acristalamiento	A000.2351	2B+2H
junta cuña int	A000.XXXX	2B+2H

accesorios de maniobra no indicados (ver catalogo de maniobra)

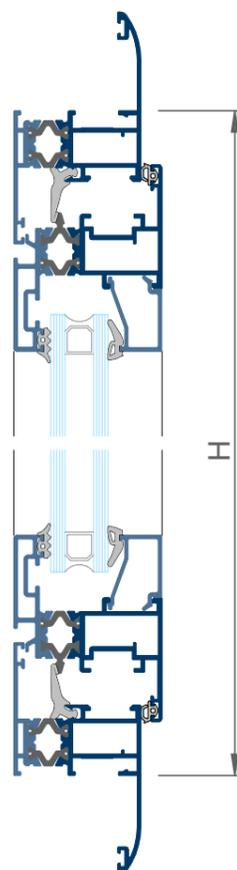

FORMULAS DE CORTE			
	UDS	FORMULA	FORMA
marco horizontal	AR52.4110	2	B \---/
marco vertical	AR52.4110	2	H \---/
hoja horizontal	AR52.4223	4	(B-44)/2 \---/
hoja vertical	AR52.4223	4	H-39 \---/
inversor doble hoja	AR52.4241	1	H-107 ---
junquillo recto horizontal	A000.XXXX	4	(B-220)/2 ---
junquillo eliptico horizontal	A000.XXXX	4	(B-220)/2 \---/
junquillo recto vertical	A000.XXXX	4	H-170 ---
junquillo eliptico vertical	A000.XXXX	4	H-126 \---/
vidrio	2	(B-259)/2 x H-146	

ACCESORIOS		
	UDS	
escuadra	A000.2110	12
escuadra alineacion int hoja	A000.2132	8
deflector desagüe	A000.2301	3
junta central	A000.2310	2B+3H
junta int hoja	A000.2320	2B+3H
junta ext acristalamiento	A000.2351	2B+4H
junta cuña int	A000.XXXX	2B+4H
juego tapas estanq central	A000.2340	1
juego tapas estética central	A000.2342	1

accesorios de maniobra no indicados (ver catalogo de maniobra)

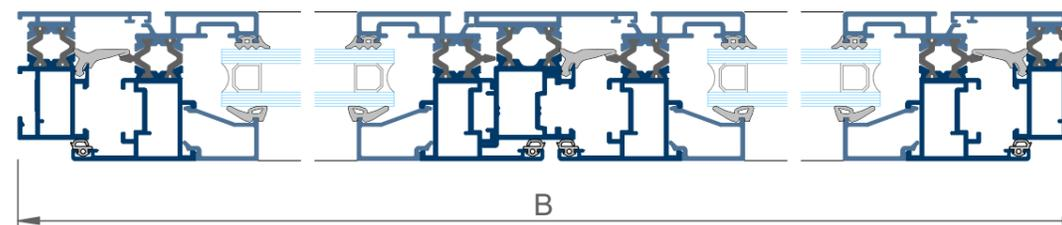
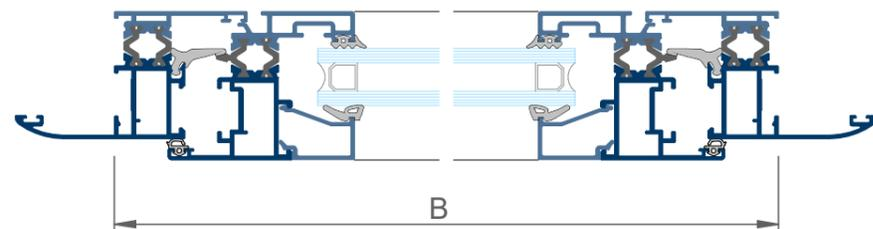
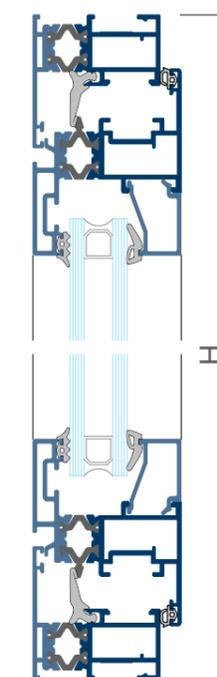

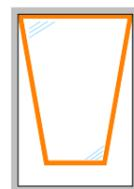

FORMULAS DE CORTE				
	UDS	FORMULA	FORMA	
marco horizontal	AR52.4110	2	B	\---/
marco vertical	AR52.4110	2	H	---
hoja horizontal	AR52.4270	2	B-39	\---/
hoja vertical	AR52.4270	2	H-39	---
junquillo recto horizontal	A000.XXXX	2	B-162	---
junquillo eliptico horizontal	A000.XXXX	2	B-162	\---/
junquillo recto vertical	A000.XXXX	2	H-206	---
junquillo eliptico vertical	A000.XXXX	2	H-162	\---/
vidrio 1 B-176 x H-176				

ACCESORIOS		
	UDS	UDS
escuadra marco	A000.2110	4
escuadra hoja	A000.2110	4
escuadra alineacion int hoja	A000.2132	4
junta int hoja	A000.2320	2B+2H
junta ext acristalamiento	A000.2351	2B+2H
junta cuña int	A000.XXXX	2B+2H

accesorios de maniobra no indicados (ver catalogo de maniobra)

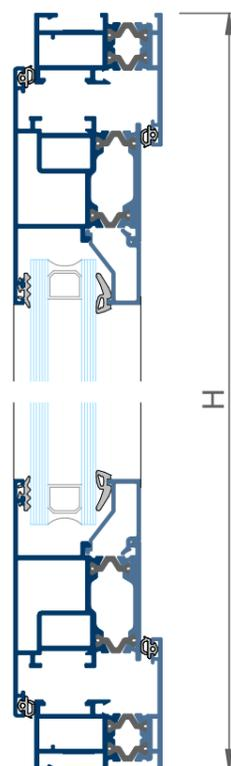
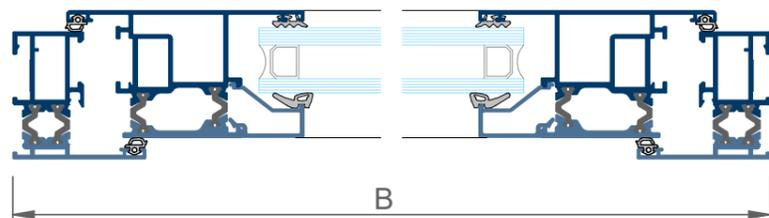

FORMULAS DE CORTE				
	UDS	FORMULA	FORMA	
marco horizontal	AR52.4150	1	B	\---/
marco vertical	AR52.4150	2	H	---
hoja horizontal	AR52.4250	2	B-88	\---/
hoja vertical	AR52.4250	2	H-52	---
perfil hoja bajo puerta	A000.4006	1	B-123	---
perfil umbral bajo puerta	A000.4007	1	B-91	---
junquillo recto horizontal	A000.XXXX	2	B-231	---
junquillo eliptico horizontal	A000.XXXX	2	B-231	\---/
junquillo recto vertical	A000.XXXX	2	H-239	---
junquillo eliptico vertical	A000.XXXX	2	H-195	\---/
vidrio 1 B-249 x H-213				

ACCESORIOS		
	UDS	UDS
escuadra marco	A000.2113	2
escuadra hoja	A000.2114	4
escuadra alineacion int hoja	A000.2132	4
junta central	A000.2310	1B+2H
junta int hoja	A000.2320	2B+2H
junta ext acristalamiento	A000.2351	2B+2H
junta cuña int	A000.XXXX	2B+2H
junta bajo puerta	CF31.2352	1B

accesorios de maniobra no indicados (ver catalogo de maniobra)

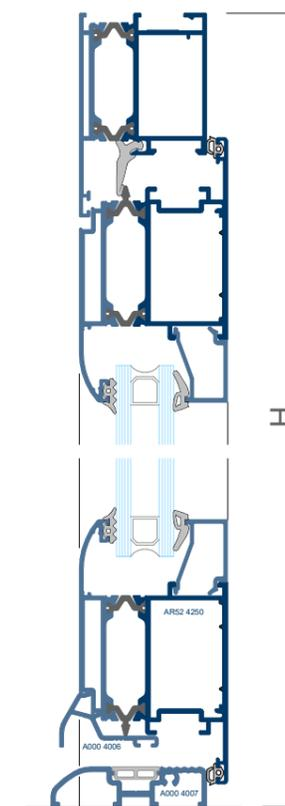
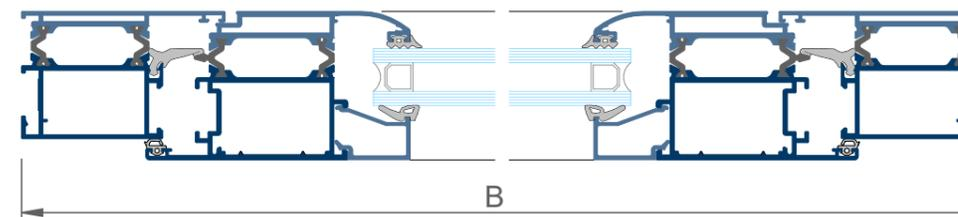

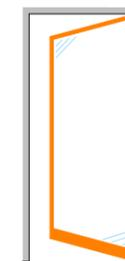
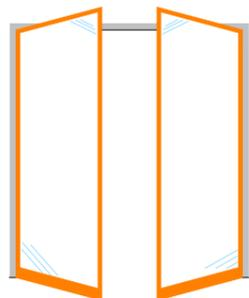

FORMULAS DE CORTE				
	UDS	FORMULA	FORMA	
marco horizontal	AR52.4150	1	B	\---/
marco vertical	AR52.4150	2	H	---/ \---
hoja horizontal	AR52.4250	4	(B-93)/2	\---/
hoja vertical	AR52.4250	4	H-52	\---/
inversor doble hoja	AR52.4241	1	H-120	---
perfil hoja bajo puerta	A000.4006	1	(B-163)/2	---
perfil hoja bajo puerta	A000.4006	1	(B-92)/2	---
perfil umbral bajo puerta	A000.4007	1	B-91	---
junquillo recto horizontal	A000.XXXX	4	(B-379)/2	---
junquillo eliptico horizontal	A000.XXXX	4	(B-379)/2	\---/
junquillo recto vertical	A000.XXXX	4	H-239	---
junquillo eliptico vertical	A000.XXXX	4	H-195	\---/
vidrio	2	(B-415)/2 x H-213		

ACCESORIOS		
	UDS	
escuadra marco	A000.2113	2
escuadra hoja	A000.2114	8
escuadra alineacion int hoja	A000.2132	8
juego tapas estanquidad central	A000.2340	1
juego tapas estética central	A000.2342	1
junta central	A000.2310	1B+3H
junta int hoja	A000.2320	2B+4H
junta ext acristalamiento	A000.2351	2B+4H
junta cuña int	A000.XXXX	2B+4H
junta bajo puerta	CF31.2352	1B

accesorios de maniobra no indicados (ver catalogo de maniobra)

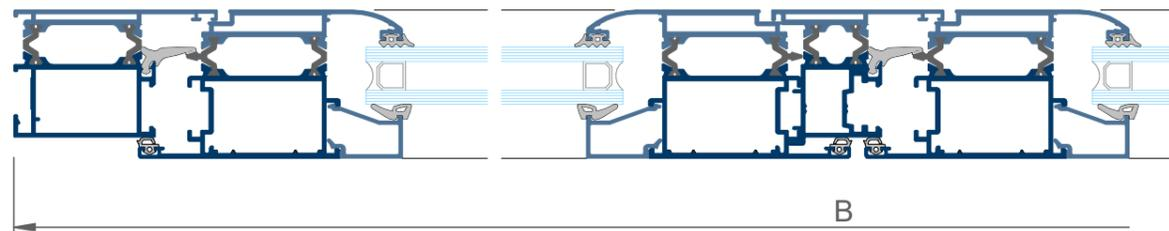
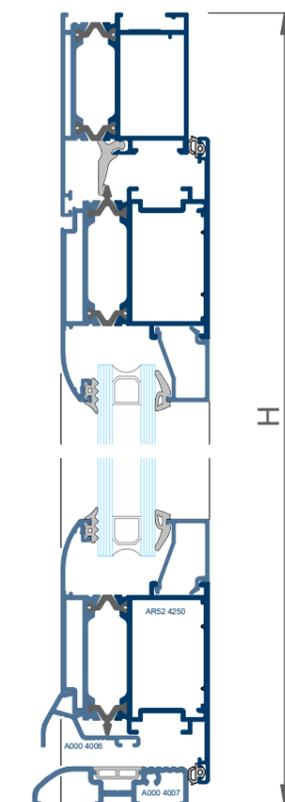

FORMULAS DE CORTE				
	UDS	FORMULA	FORMA	
marco horizontal	AR52.4150	1	B	\---/
marco vertical	AR52.4150	2	H	---/ \---
hoja horizontal	AR52.4260	2	B-88	\---/
hoja vertical	AR52.4260	2	H-52	\---/
perfil hoja bajo puerta	A000.4006	1	B-123	---
perfil umbral bajo puerta	A000.4007	1	B-91	---
junquillo recto horizontal	A000.XXXX	2	B-231	---
junquillo eliptico horizontal	A000.XXXX	2	B-231	\---/
junquillo recto vertical	A000.XXXX	2	H-239	---
junquillo eliptico vertical	A000.XXXX	2	H-195	\---/
vidrio	1	B-249 x H-213		

ACCESORIOS		
	UDS	
escuadra marco	A000.2113	2
escuadra hoja	A000.2114	4
escuadra alineacion int hoja	A000.2132	4
junta central	A000.2310	1B+2H
junta int hoja	A000.2320	2B+2H
junta ext acristalamiento	A000.2351	2B+2H
junta cuña int	A000.XXXX	2B+2H
junta bajo puerta	CF31.2352	1B

accesorios de maniobra no indicados (ver catalogo de maniobra)

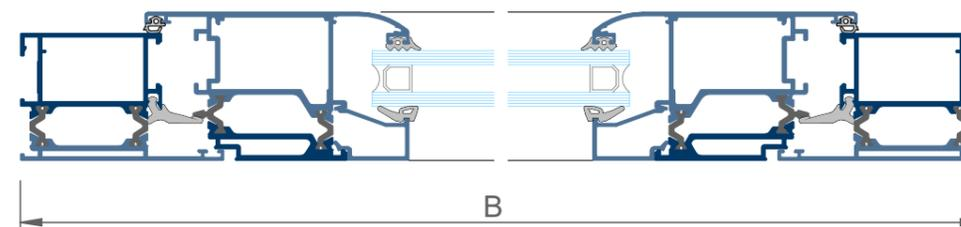
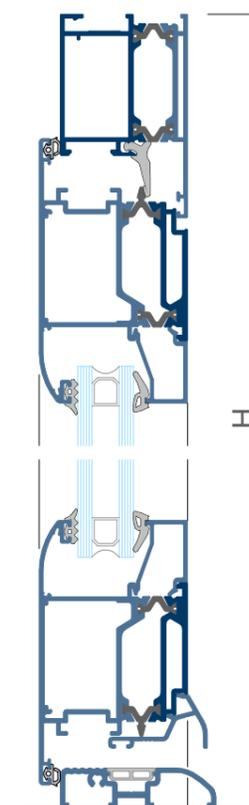

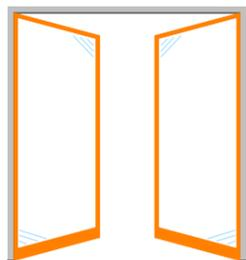

FORMULAS DE CORTE			
	UDS	FORMULA	FORMA
marco horizontal	AR52.4150	1 B	\---/
marco vertical	AR52.4150	2 H	---/ \---
hoja horizontal	AR52.4260	4 (B-93)/2	\---/
hoja vertical	AR52.4260	4 H-52	\---/
inversor doble hoja	AR52.4241	1 H-61,5	---
perfil hoja bajo puerta	A000.4006	1 B-122	---
perfil umbral bajo puerta	A000.4007	1 B-90	---
junquillo recto horizontal	A000.XXXX	4 (B-379)/2	---
junquillo elíptico horizontal	A000.XXXX	4 (B-379)/2	\---/
junquillo recto vertical	A000.XXXX	4 H-239	---
junquillo elíptico vertical	A000.XXXX	4 H-195	\---/
vidrio	2	(B-415)/2 x H-215	

ACCESORIOS		
		UDS
escuadra marco	A000.2113	2
escuadra hoja	A000.2114	8
escuadra alineacion int hoja	A000.2132	8
juego tapas estanquidad central	A000.2340	1
juego tapas estética central	A000.2342	1
junta central	A000.2310	1B+3H
junta int hoja	A000.2320	2B+4H
junta ext acristalamiento	A000.2351	2B+4H
junta cuña int	A000.XXXX	2B+4H
junta bajo puerta	CF31.2352	1B

accesorios de maniobra no indicados (ver catalogo de maniobra)

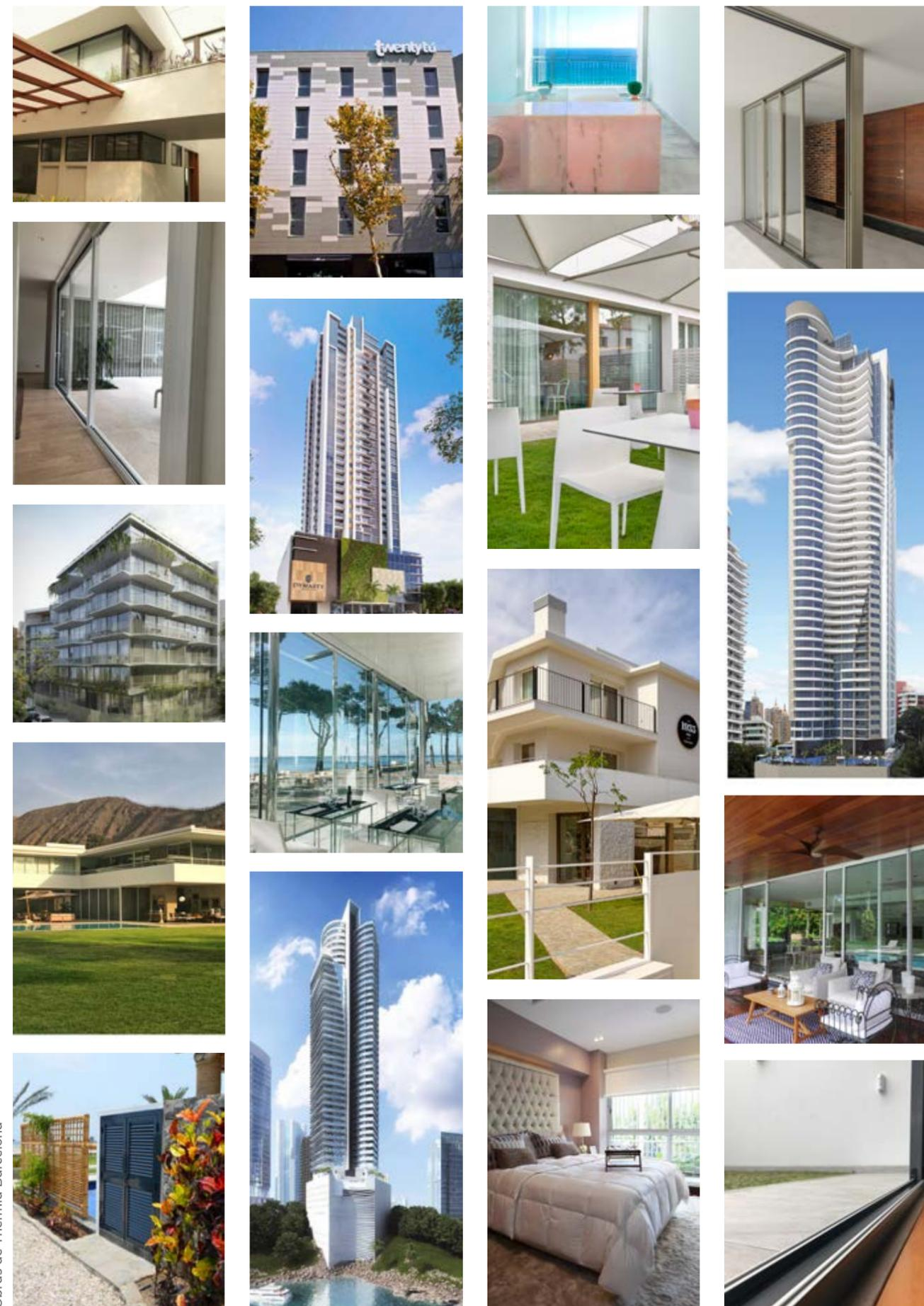
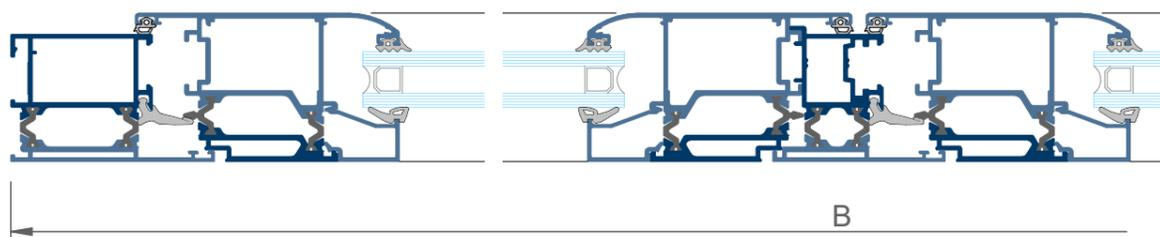
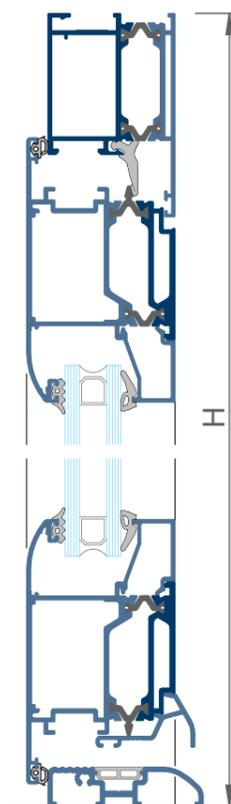

Obras de Thermia Barcelona

THERMIA®

B A R C E L O N A

Ventanas para vivir mejor

Sede Central en Barcelona

C/ Narcís Monturiol, 34
08192 Sant Quirze del Vallès
Barcelona (España)
Tel. +34 937 121 237
contacto@thermiabarcelona.com
Síguenos en   

Delegación Área Andina

Los Telares, 289
Urbanización Industrial Vulcano
Ate, Lima (Perú)
Tel. +51-1-7197649

Showrooms

Barcelona
Narcís Monturiol, 34
08192 Sant Quirze Valles
Tel. +34 937 121 237

Lima
Paseo de la República, 3583
2o. Piso - San Isidro
Tel. +51-1-7197649

Girona
Carrer Sant Jordi, 2
Local 4 - Sarrià de Ter
Tel. +34 937 121 237

THERMIABARCELONA.COM