

SISTEMA PRACTICABLE



SISTEMA PRACTICABLE / THERMIA® AF52

THERMIA® AF52
El silencio que estaba buscando.

THERMIA®
BARCELONA

Ventanas para vivir mejor

PERMEABILIDAD AL AIRE según EN 12207 - Mercado CE según EN 14351-1:2006 (E.1)

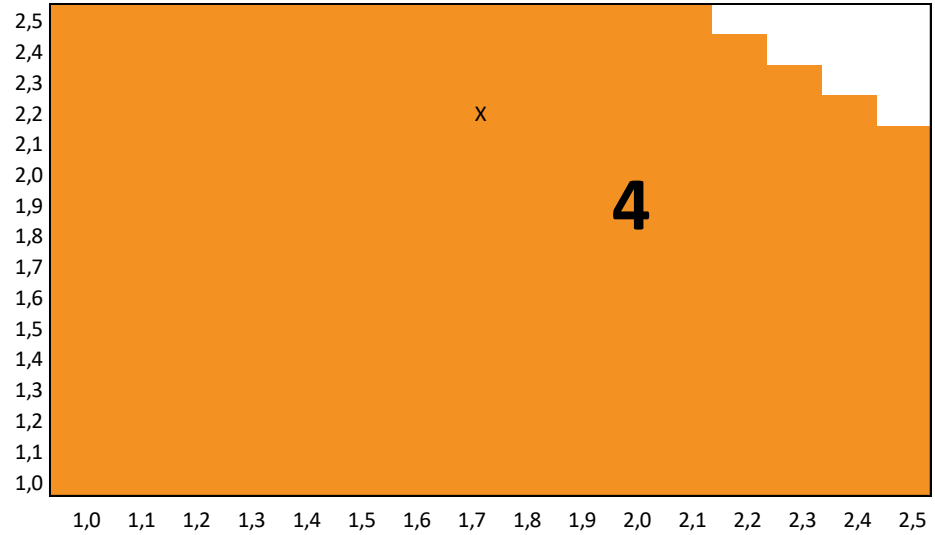

ESTANQUIDAD AL AGUA según EN 12208 - Mercado CE según EN 14351-1:2006 (E.1)

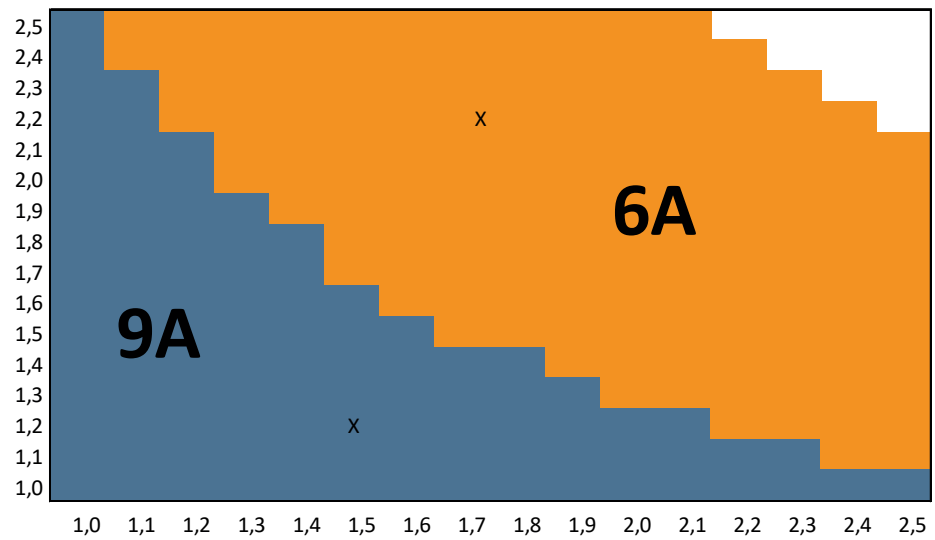

RESISTENCIA AL VIENTO según EN 12210 - Mercado CE según EN 14351-1:2006 (E.1)

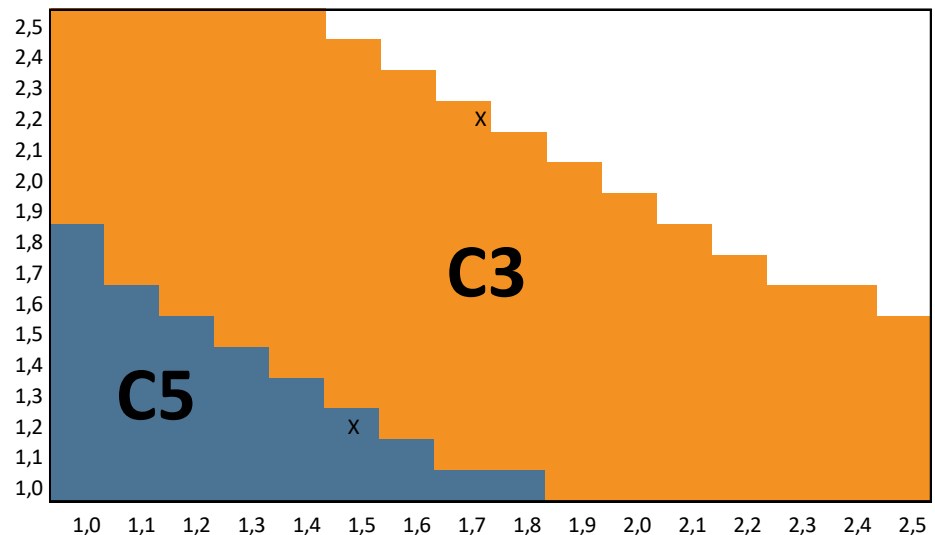

Resultados obtenidos de los informes según ensayos internos, y en base al Anexo E de la norma EN 14351-1:2006.

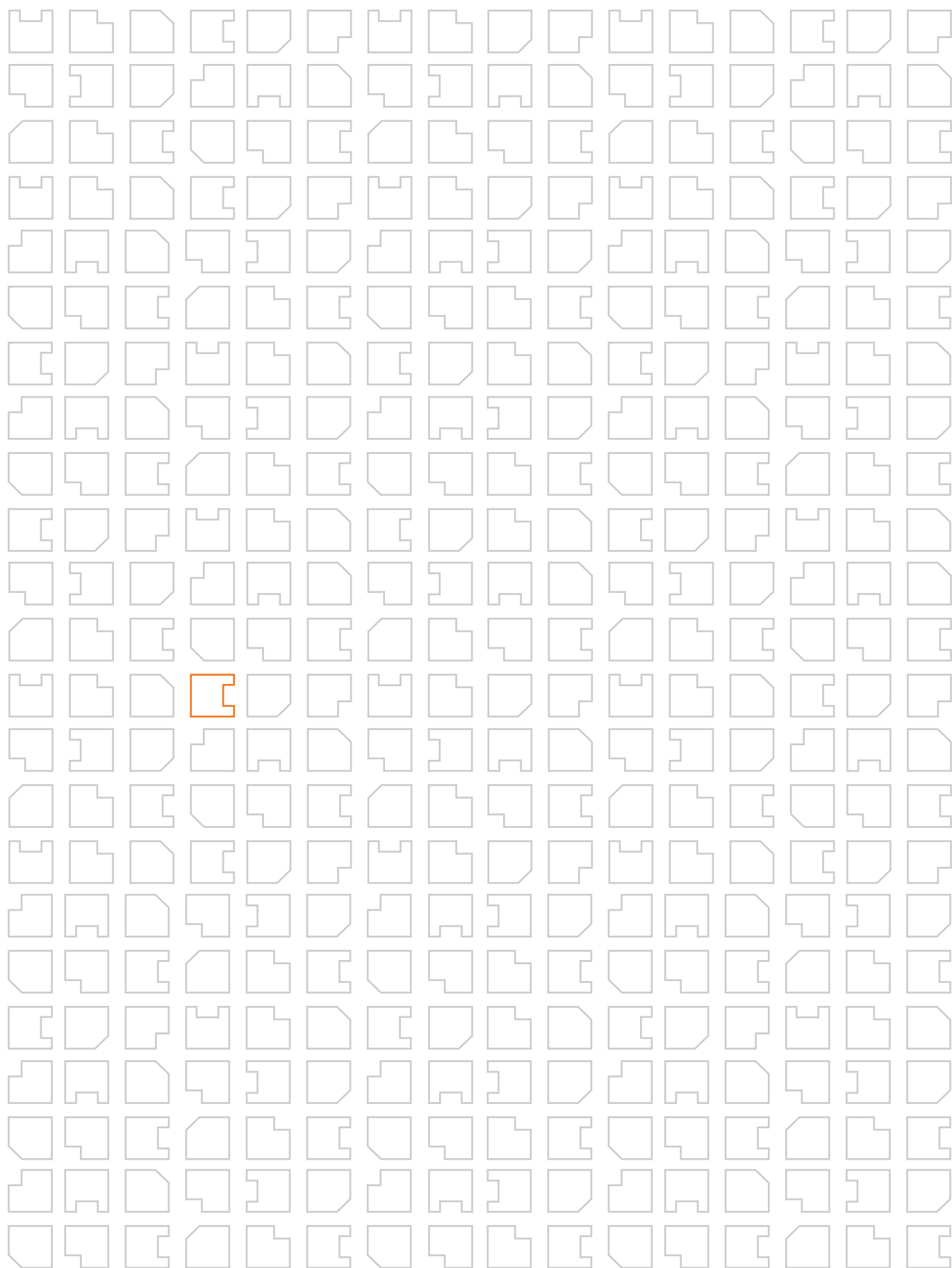

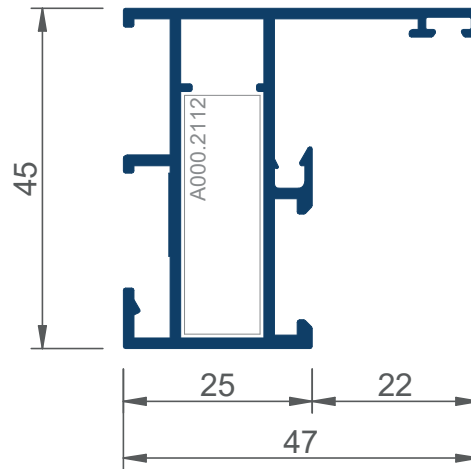

AF52 4110

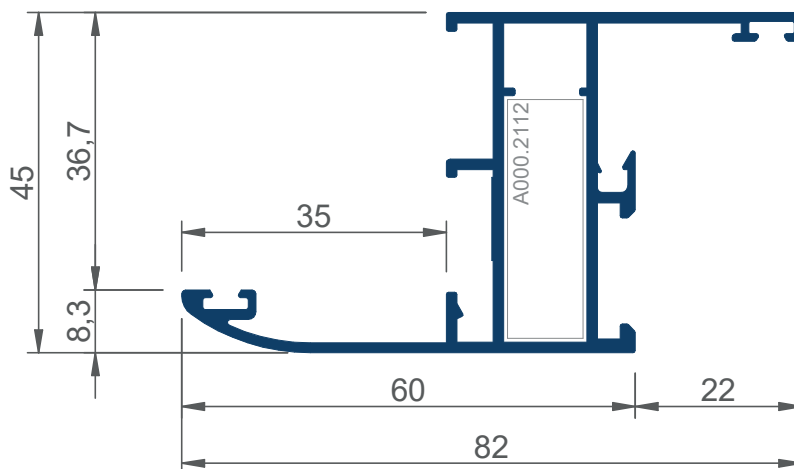

AF52 4112

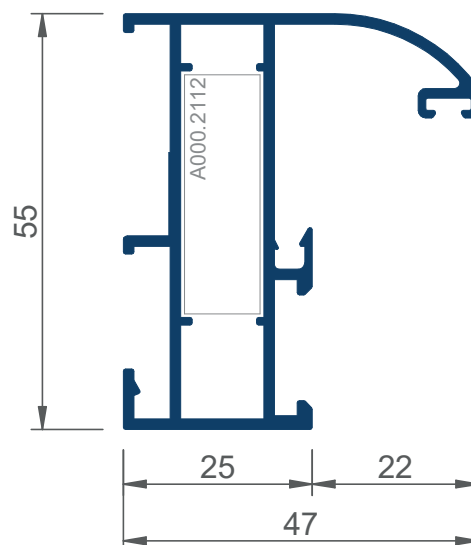

AF52 4114

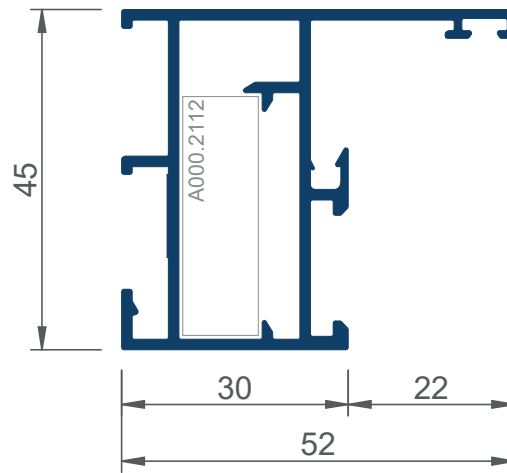

AF52 4111

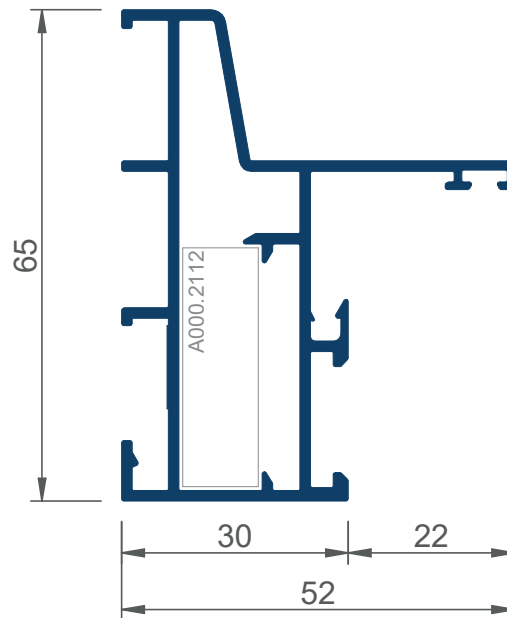

AF52 4113

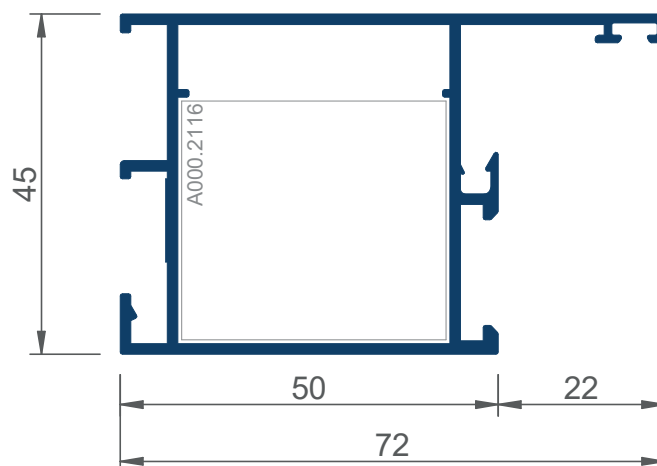

AF52 4150

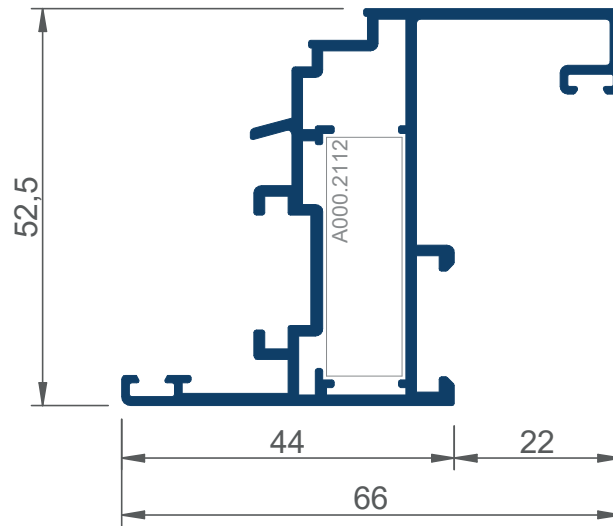

AF52 4223

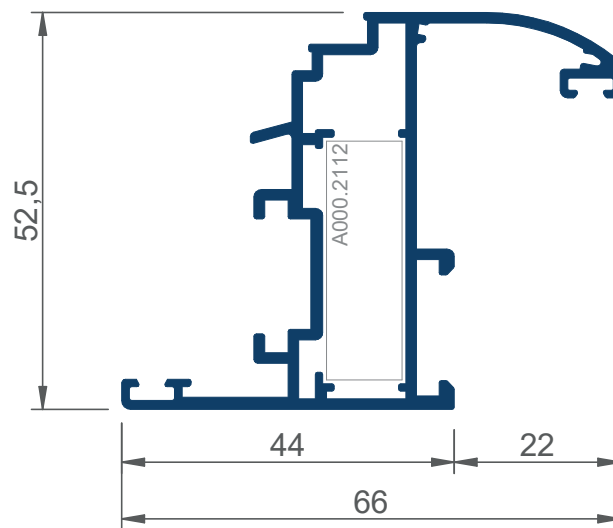

AF52 4220

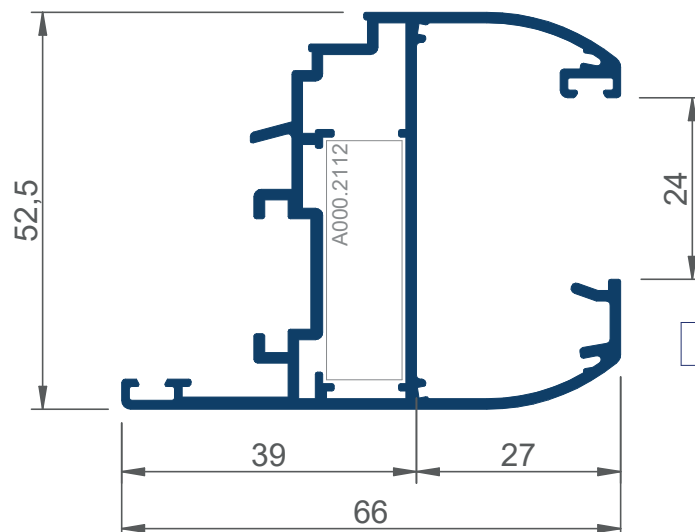

AF52 4224

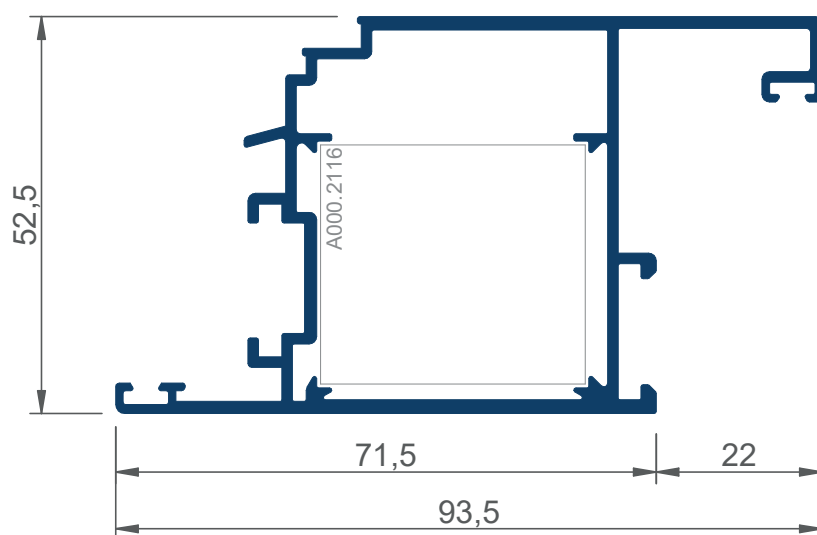

AF52 4253

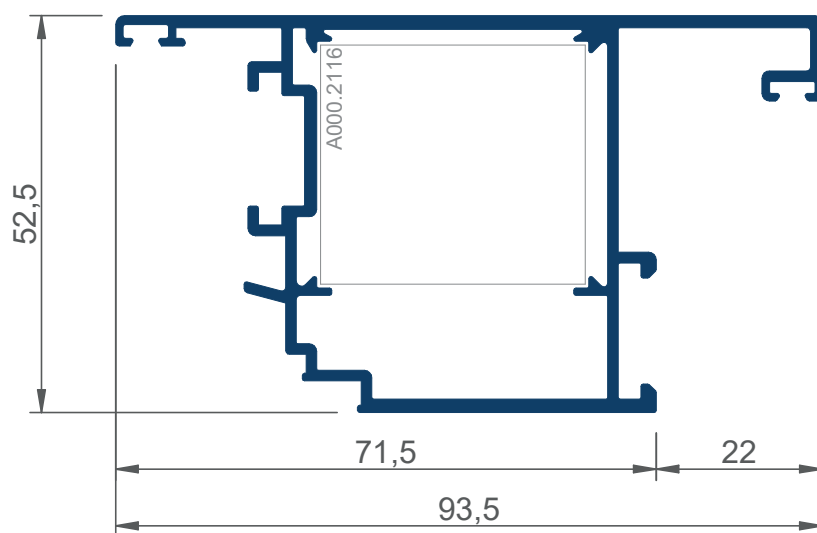

AF52 4263

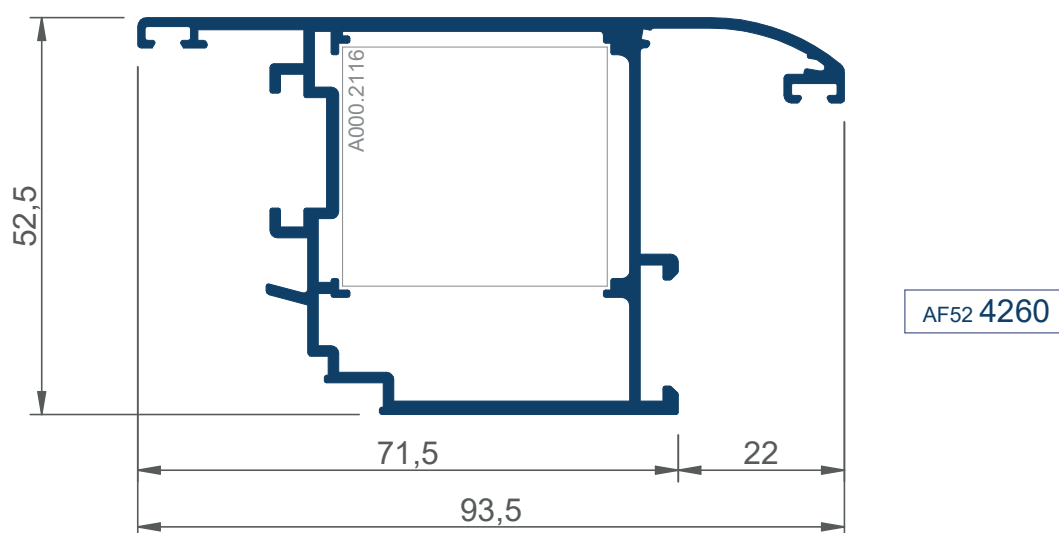
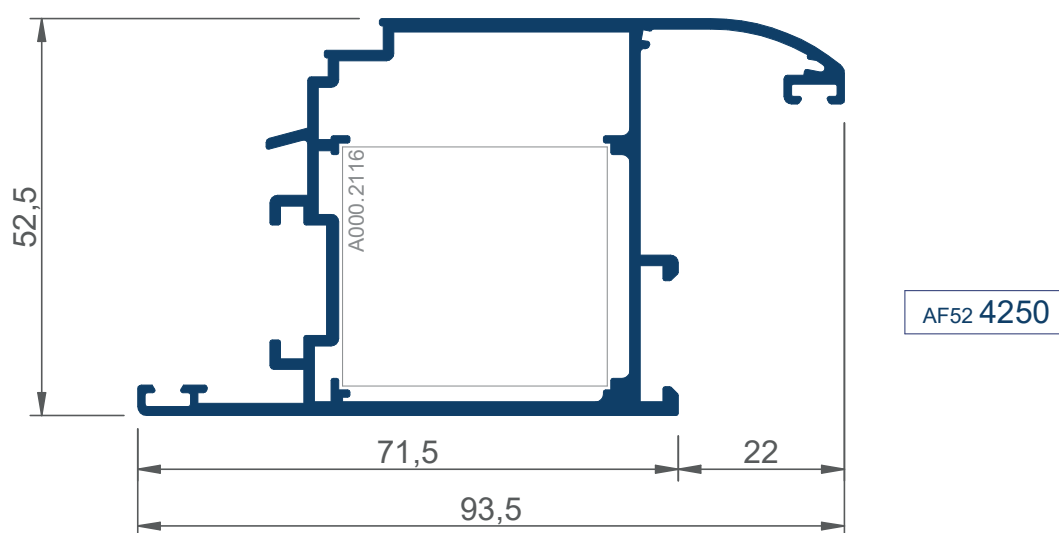

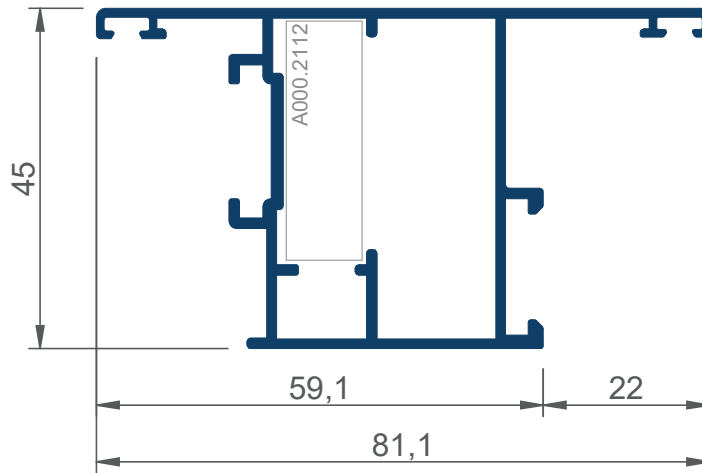

AF52 4270

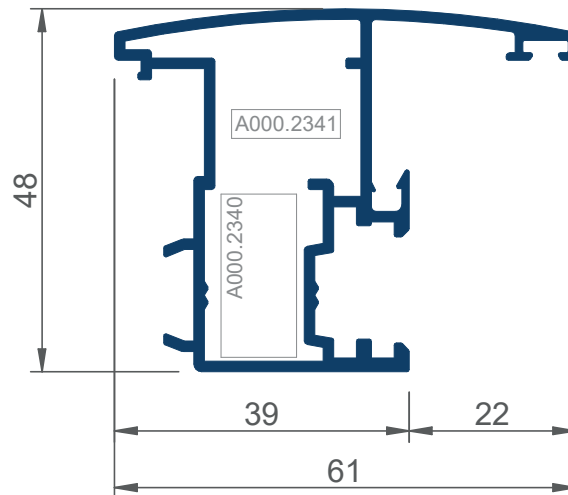

AF52 4240

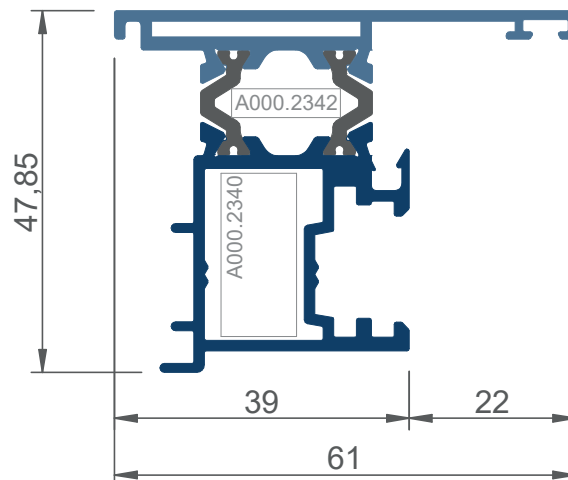

AR52 4241

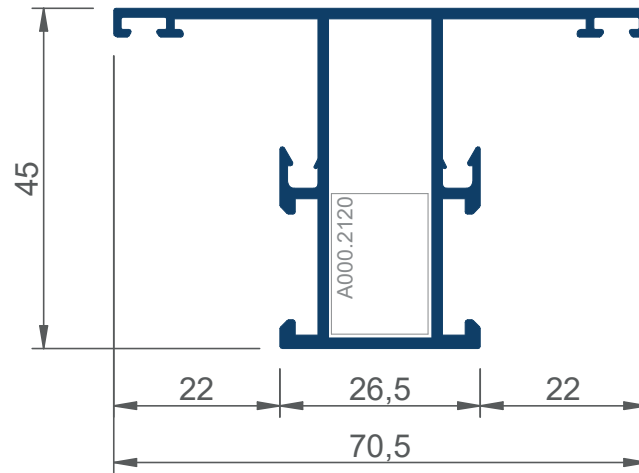

AF52 4310

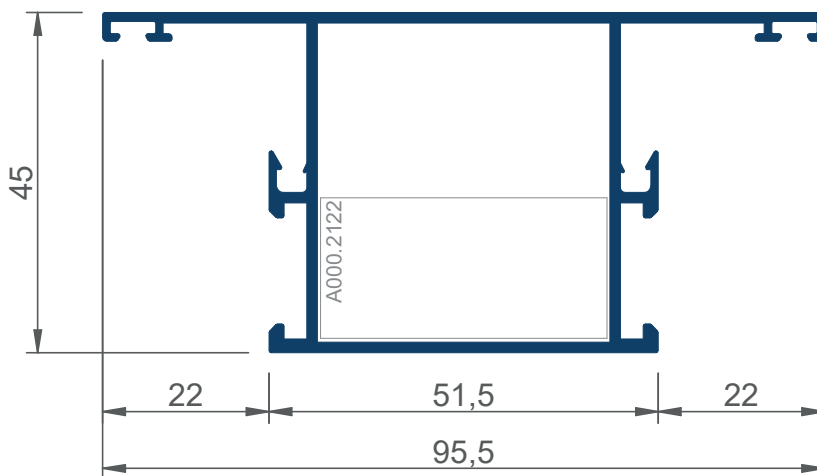

AF52 4320

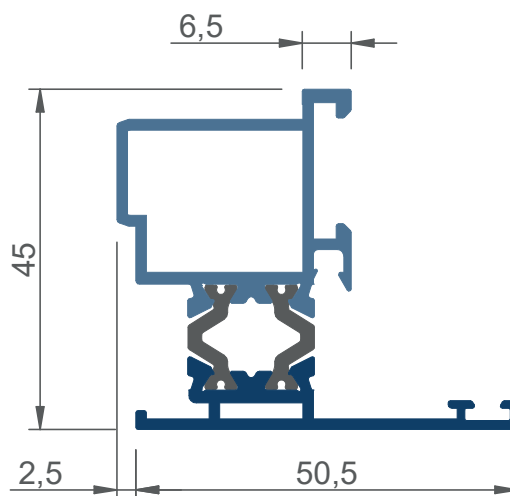

AR52 4278

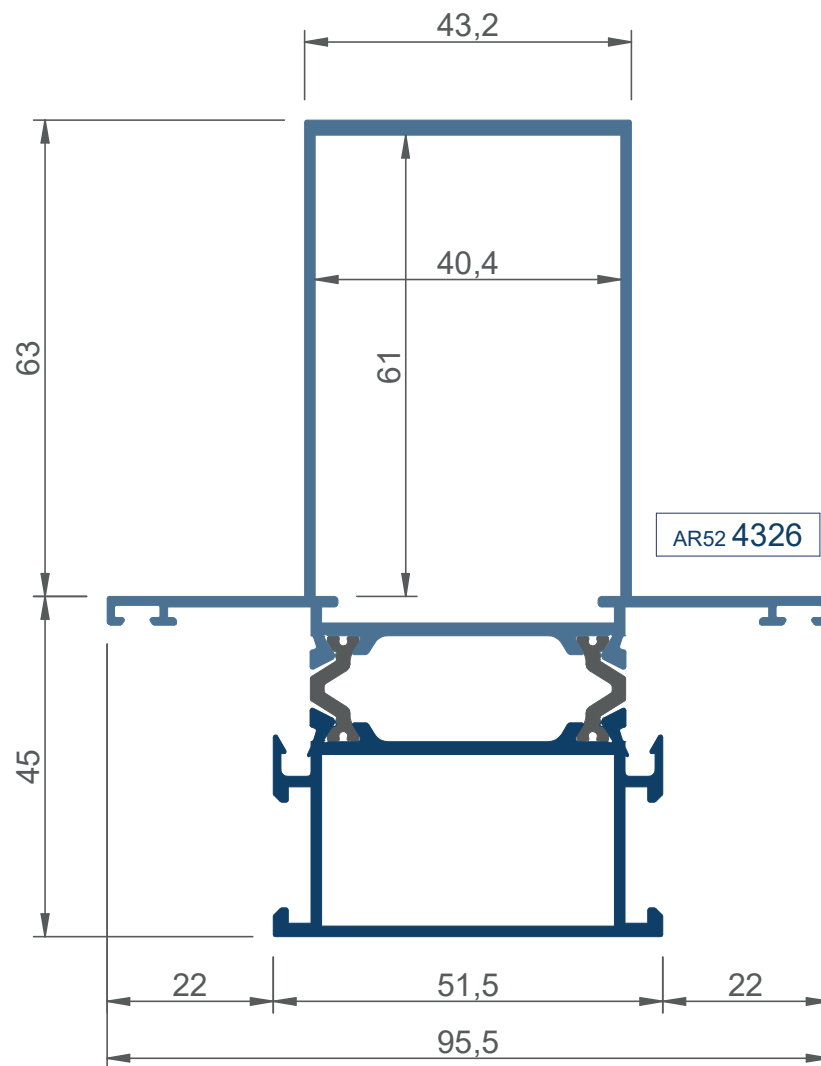

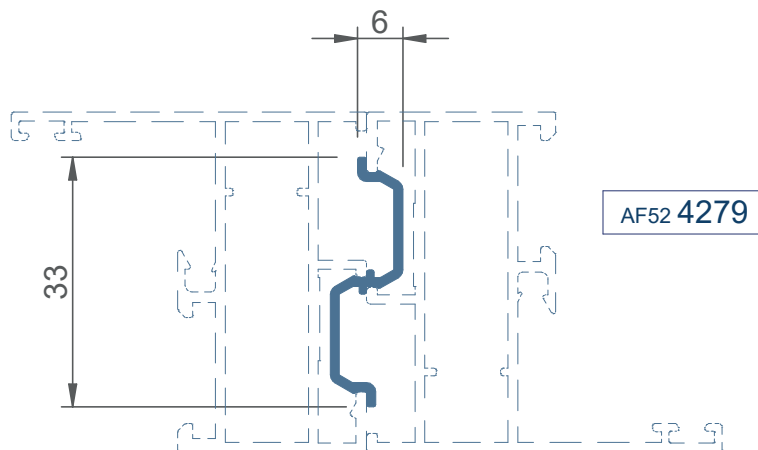
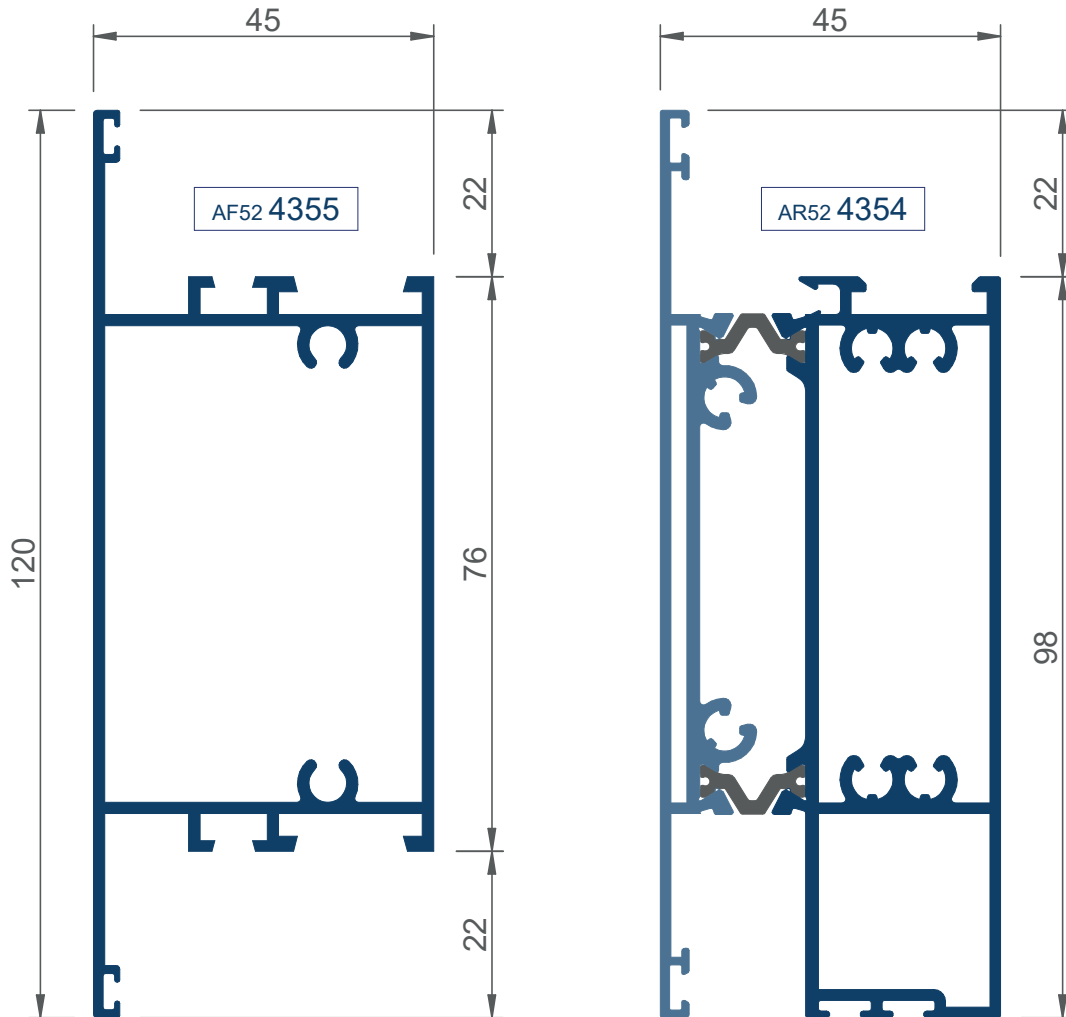

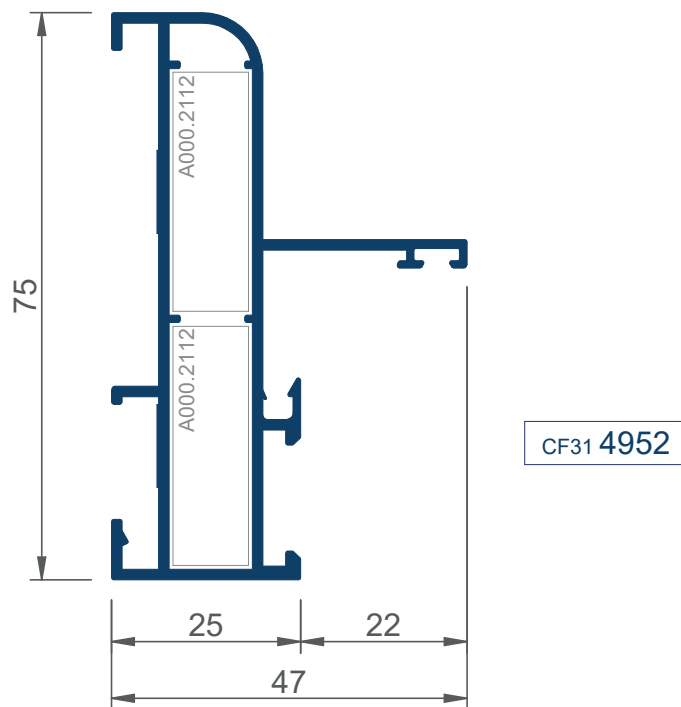
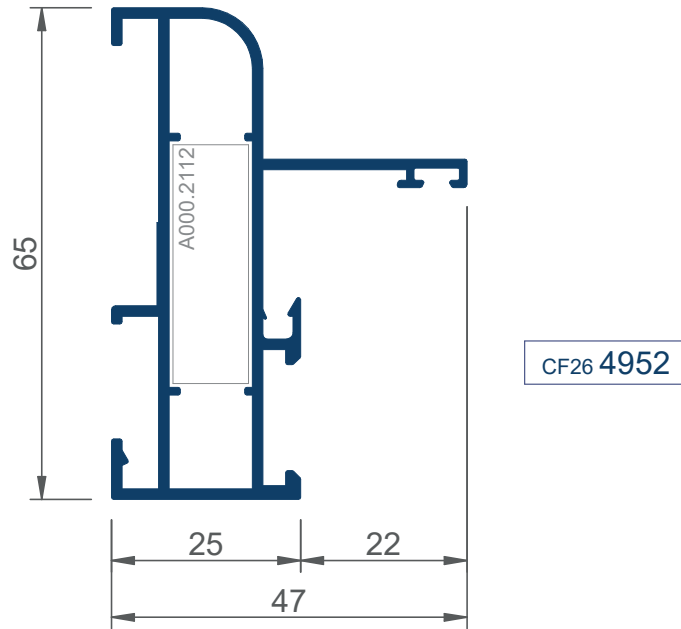

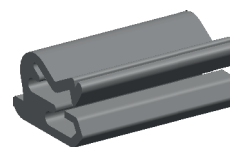
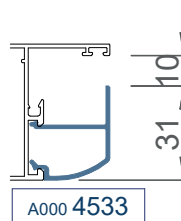
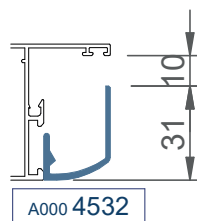
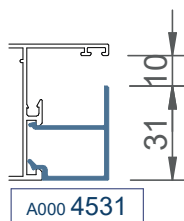
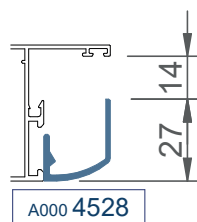
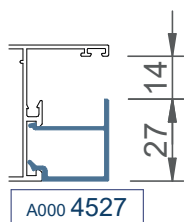
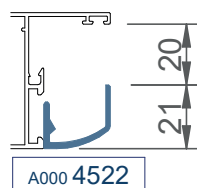
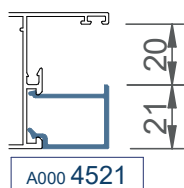
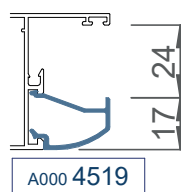
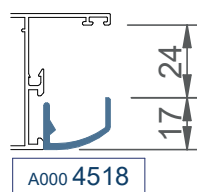
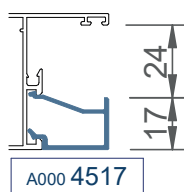
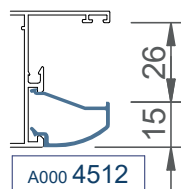
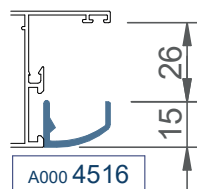
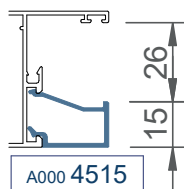
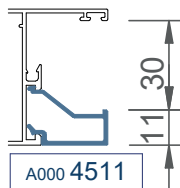
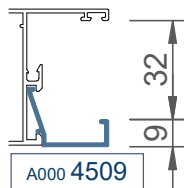

grapa junquillos elípticos

A000 2102



A000 2315

junta exterior (1mm)



A000 2351

junta exterior (2mm)



A000 2353

junta cuña (de 3 a 5mm)



A000 2355

junta cuña (de 5 a 7mm)



A000 2357

junta cuña (de 7 a 9mm)

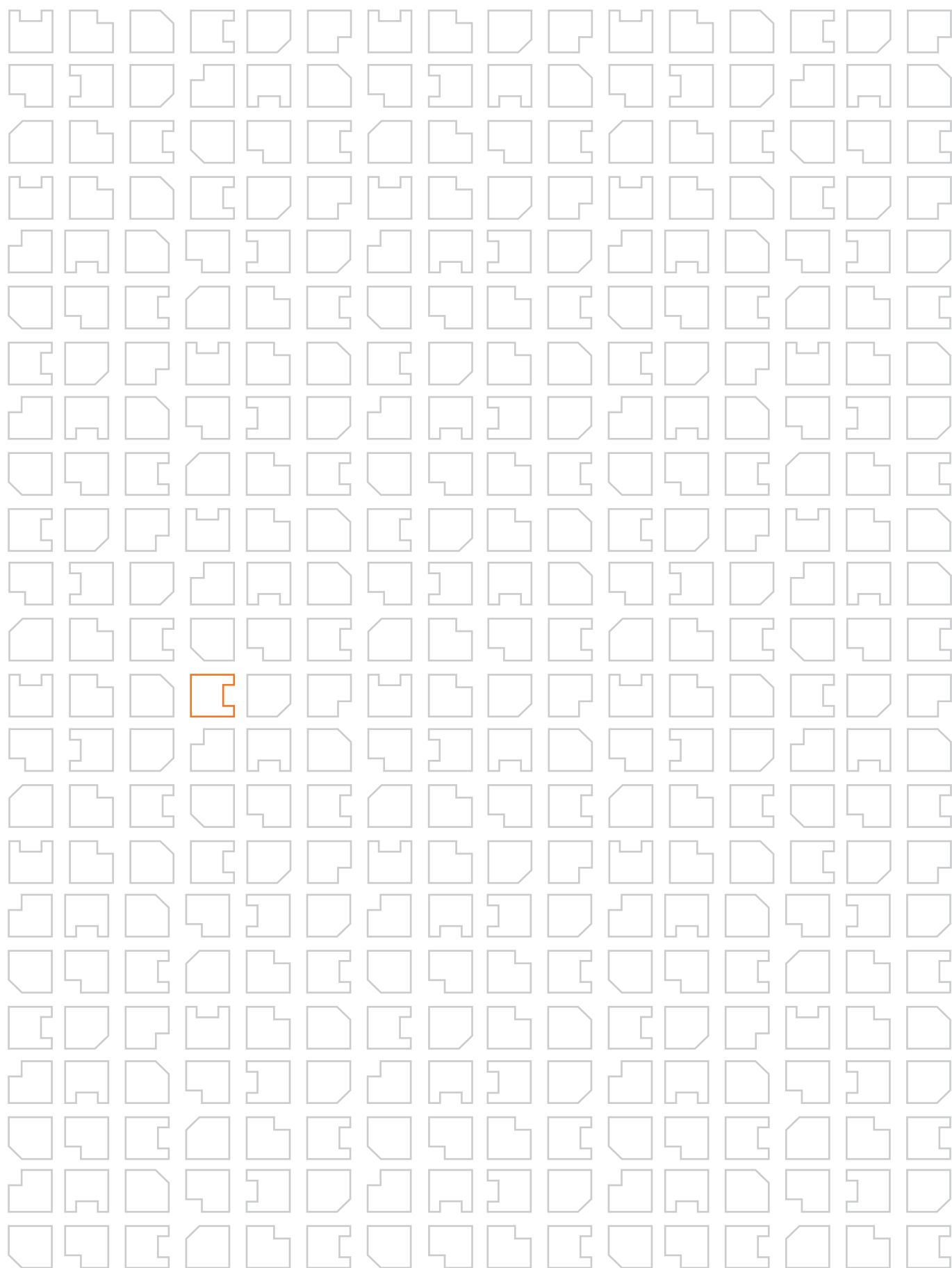

escuadra alineación alas exteriores

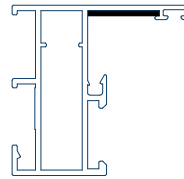

escuadra alineación ala cremona

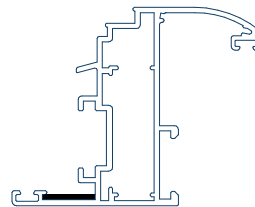

escuadra alineación multiuso

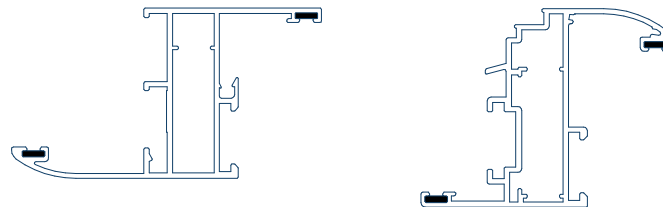
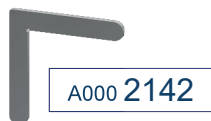

escuadra alineación multiuso
(alojamiento juntas)

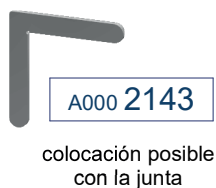

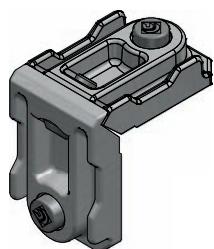

A000 2112
escuadra base

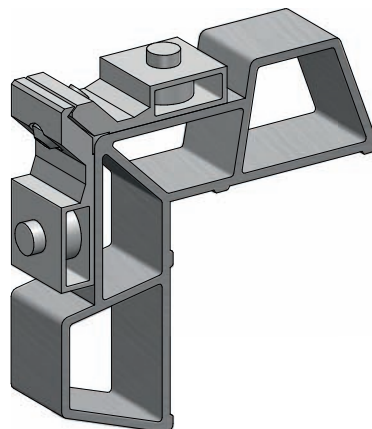

A000 2116
escuadra ancha

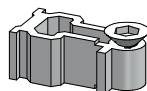

A000 2120
unión travesaño

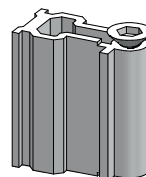

A000 2122
unión montante

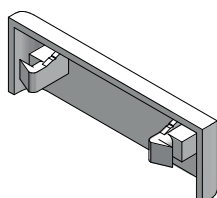

A000 2301
tapón deflector



A000 2320
junta int hoja



A000 2310

junta central

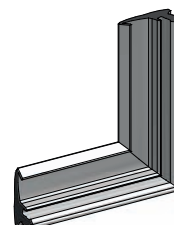

A000 2309

ángulo junta central

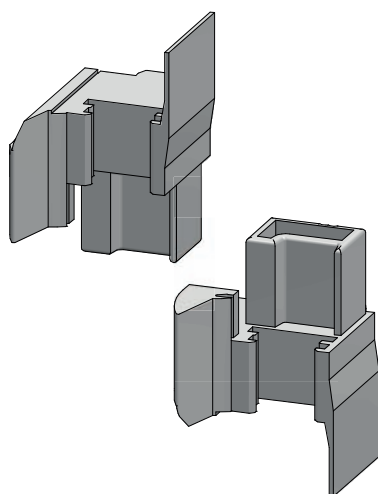

A000 2340

juego base tapas inv CE

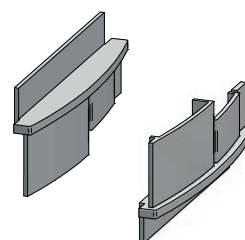

A000 2341

juegos tapas ext inv curvo

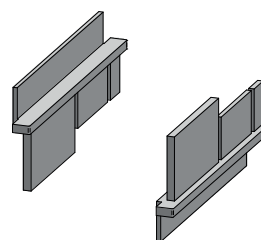

A000 2342

juego tapas ext inv recto

Para accesorios de Maniobra consultar catálogo específico

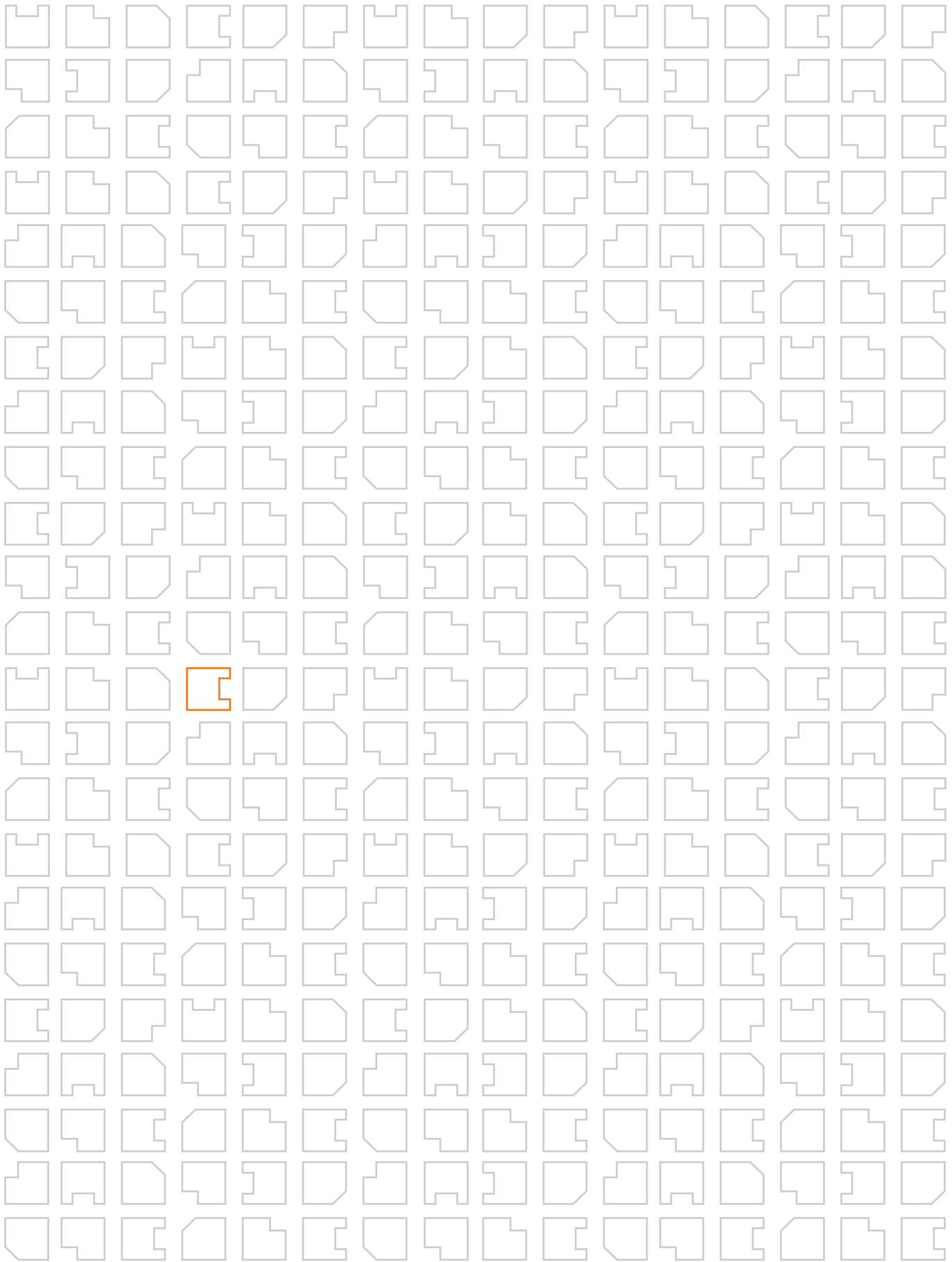

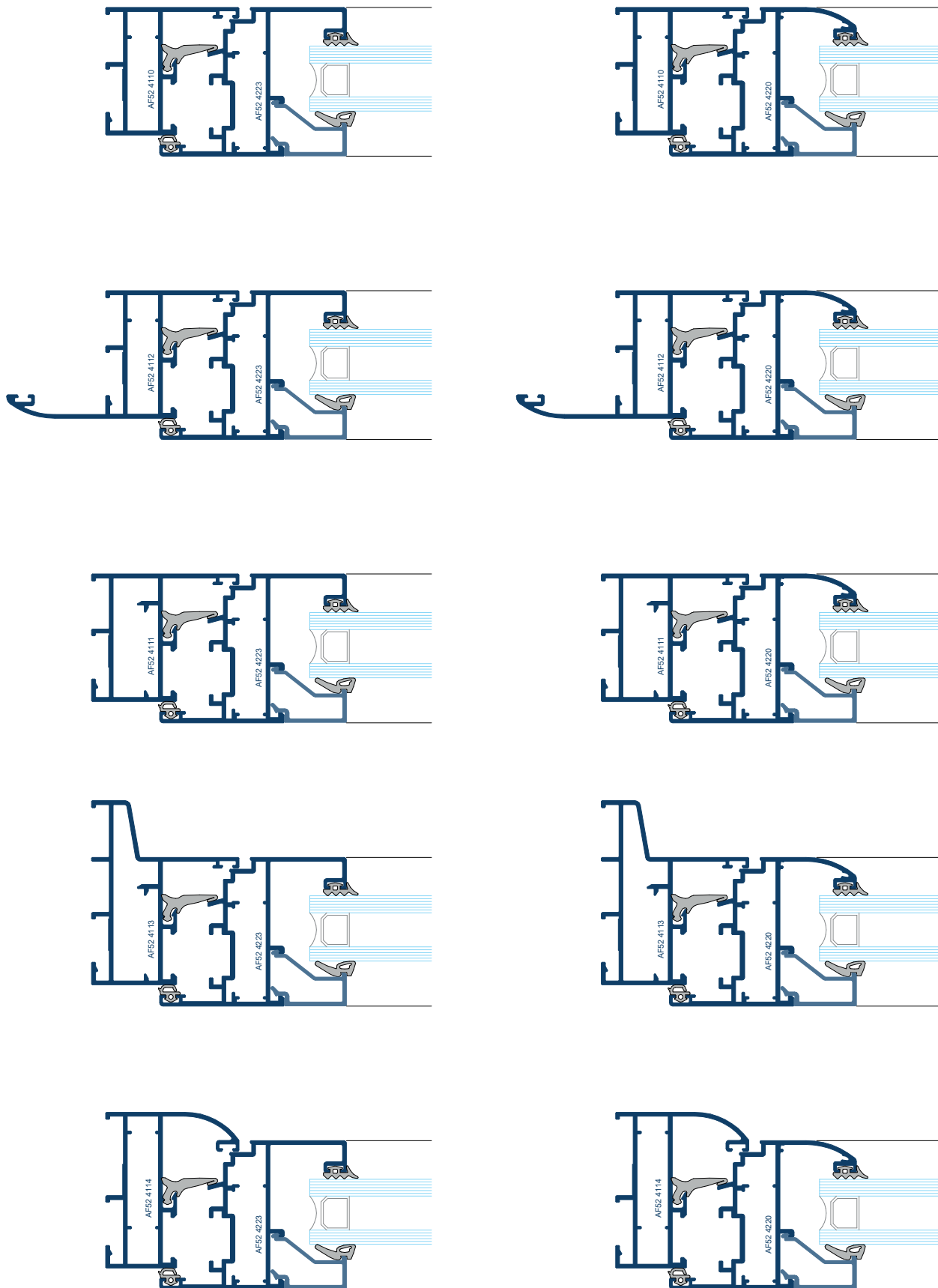

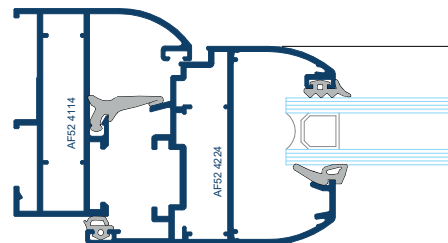
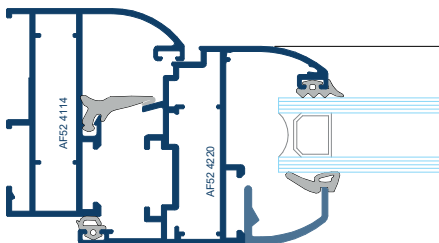
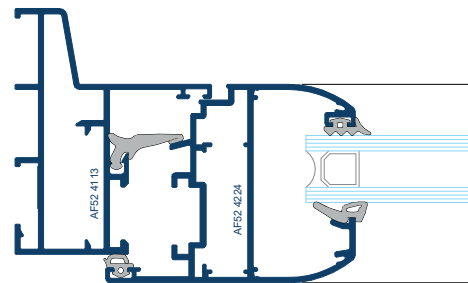
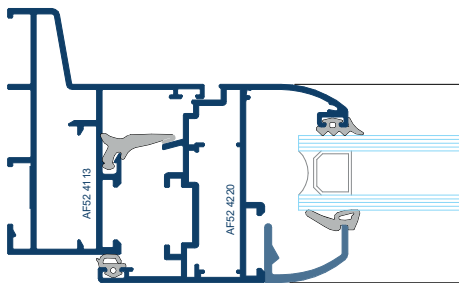
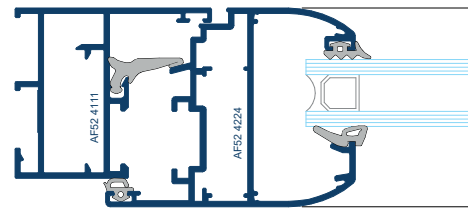
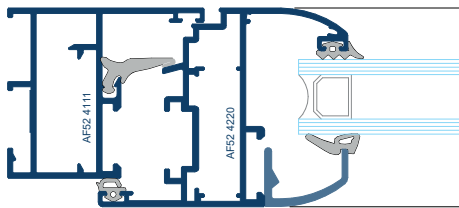
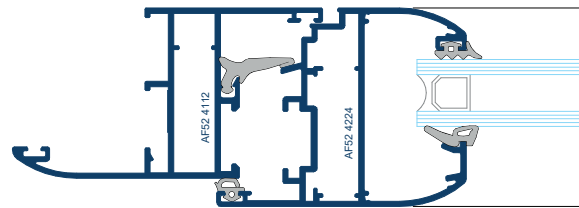
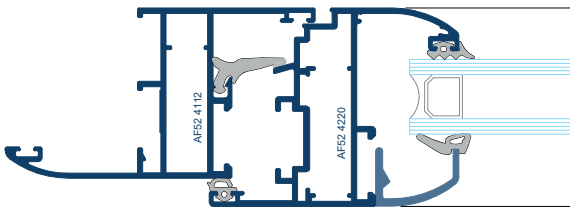
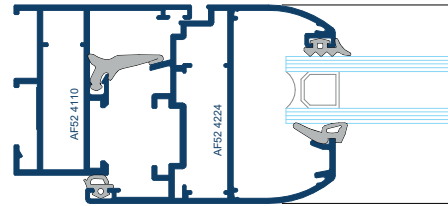
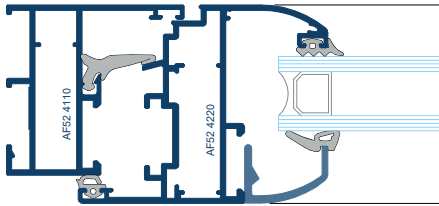

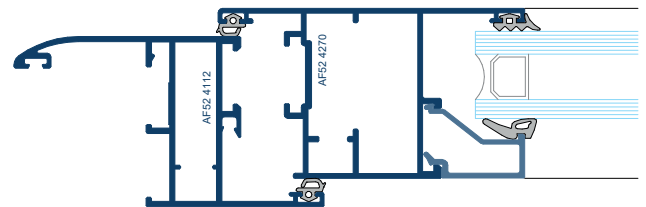
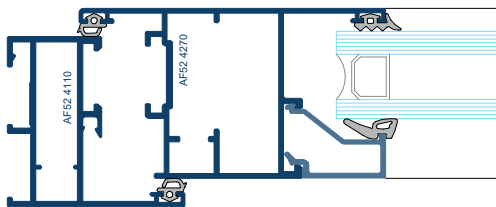
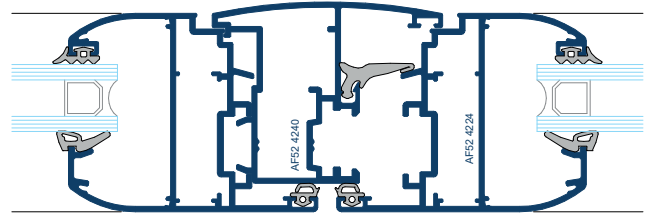
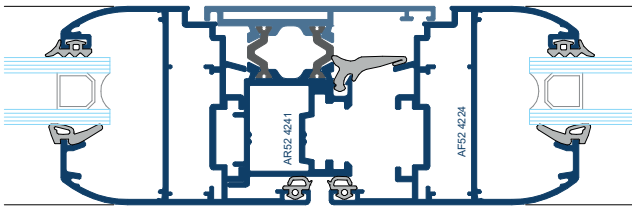
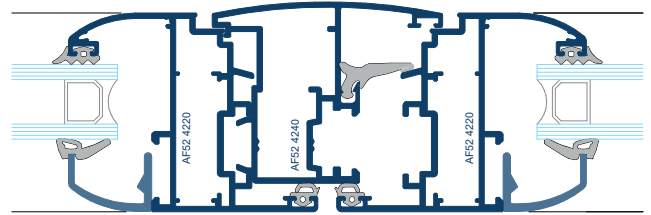
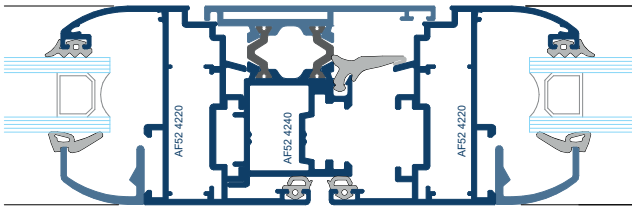
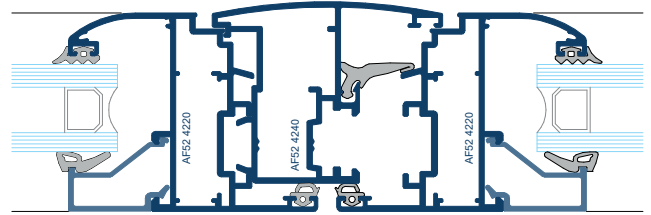
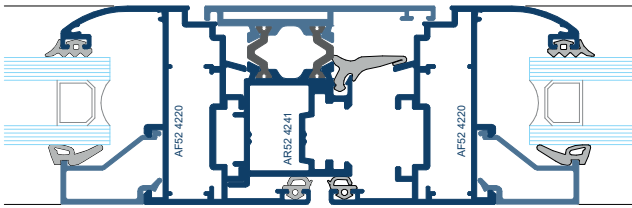
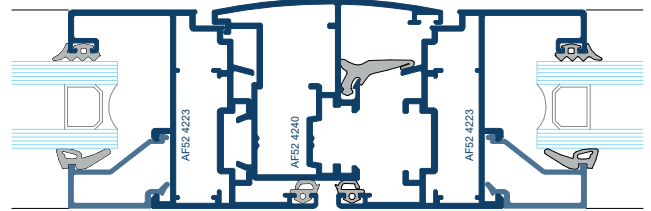
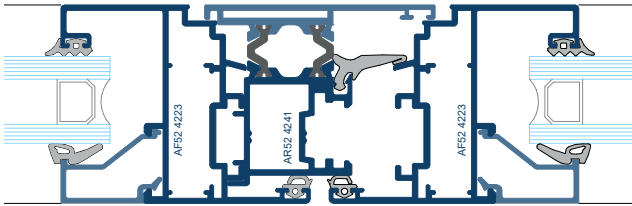

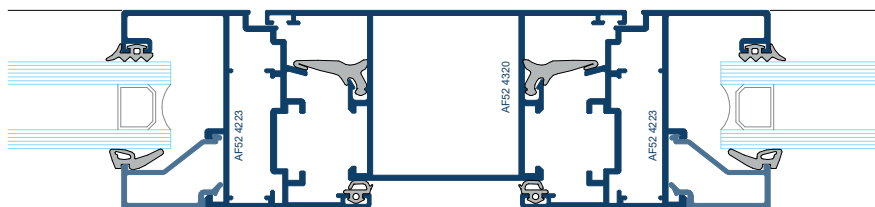
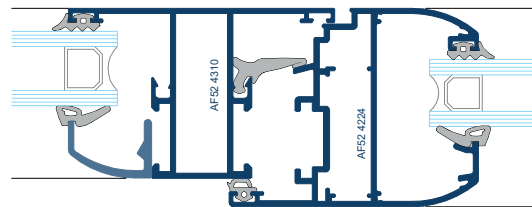
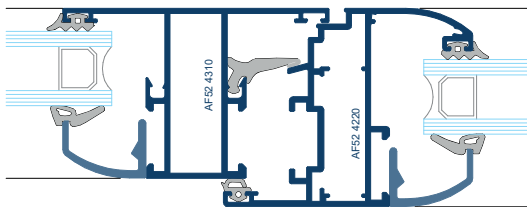
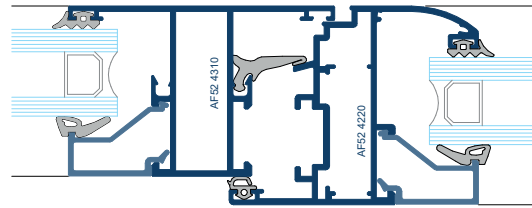
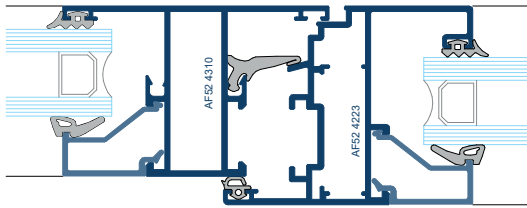
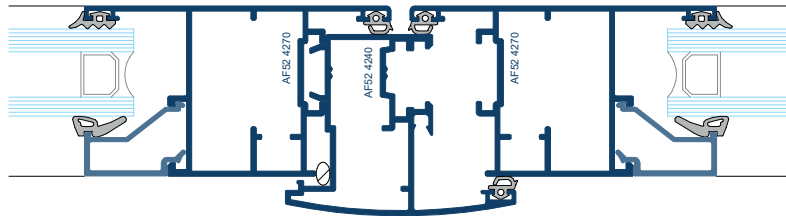
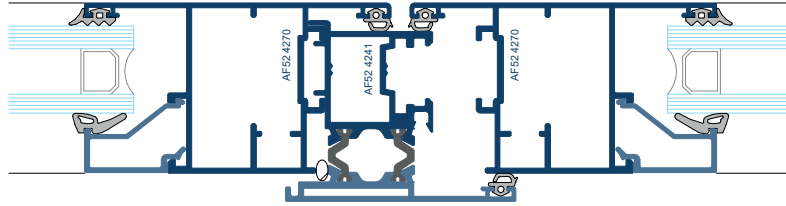

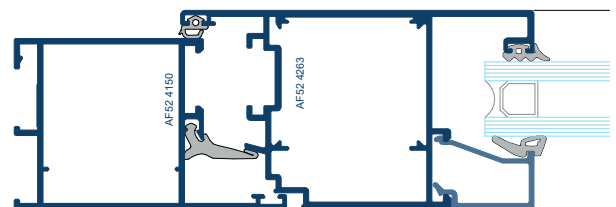
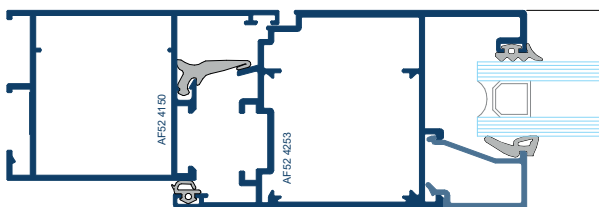
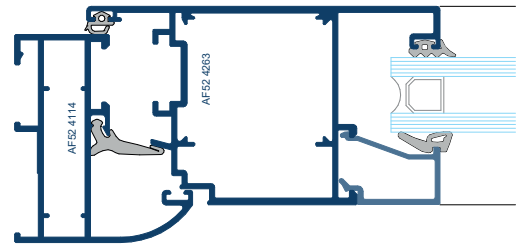
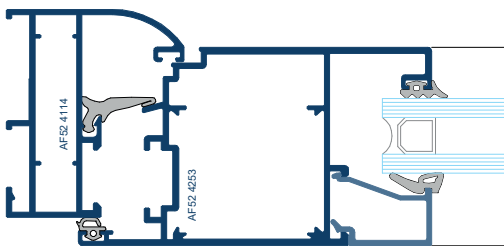
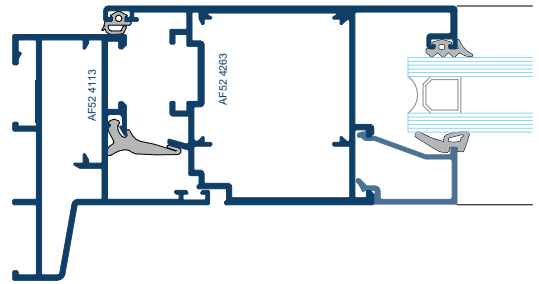
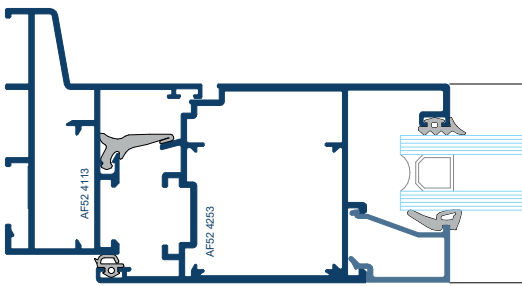
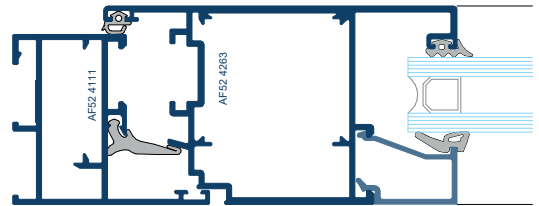
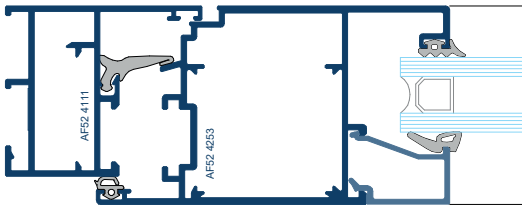
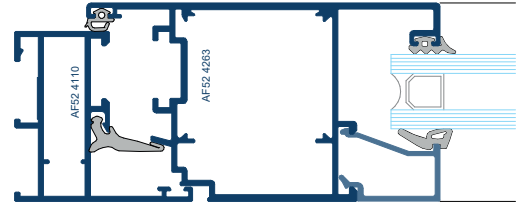
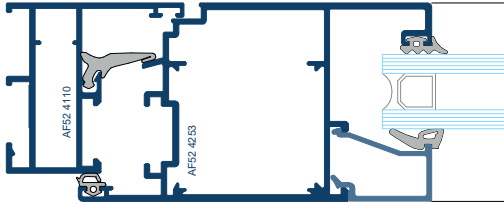

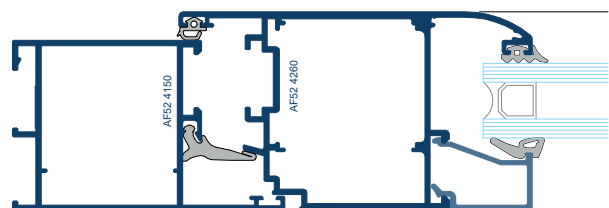
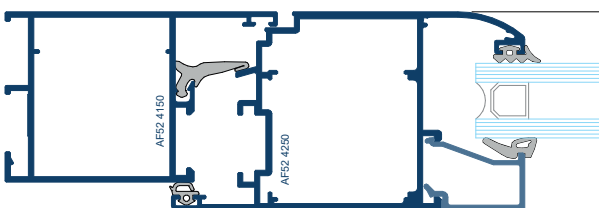
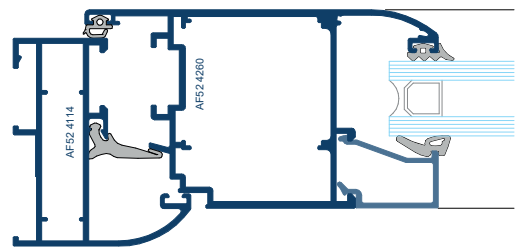
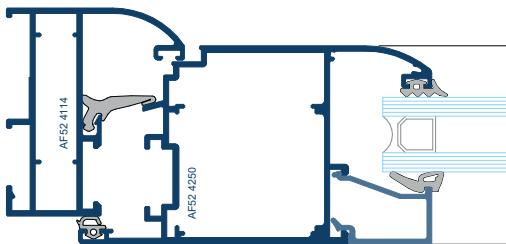
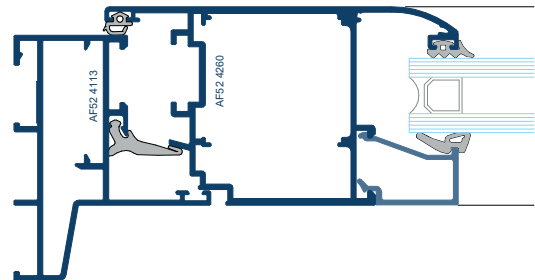
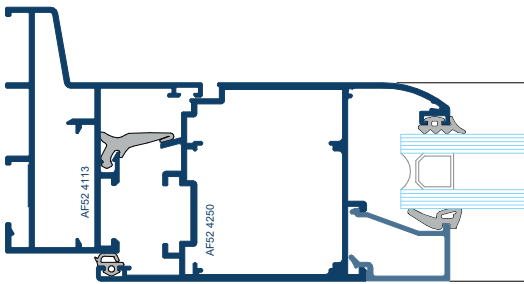
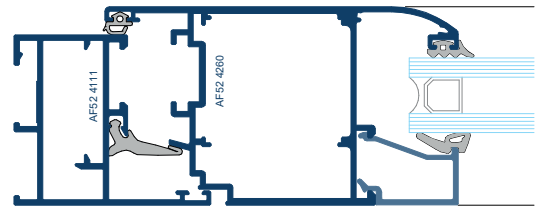
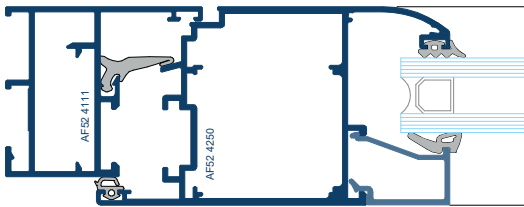
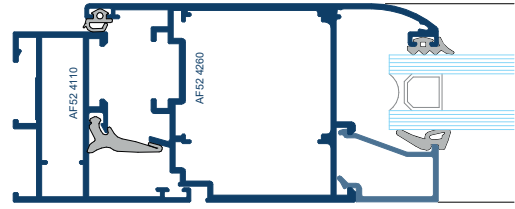
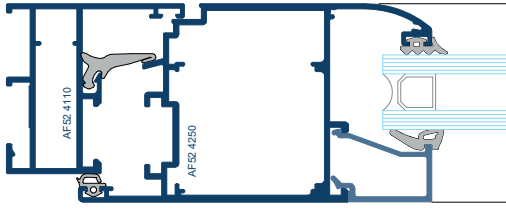

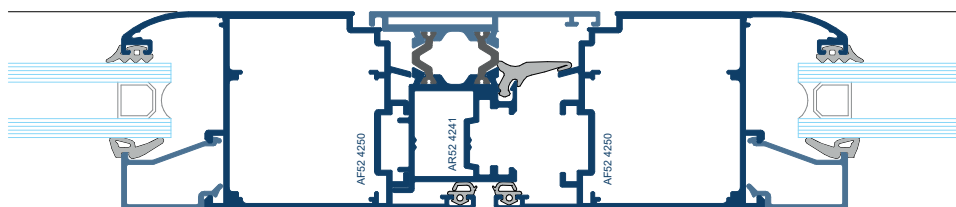
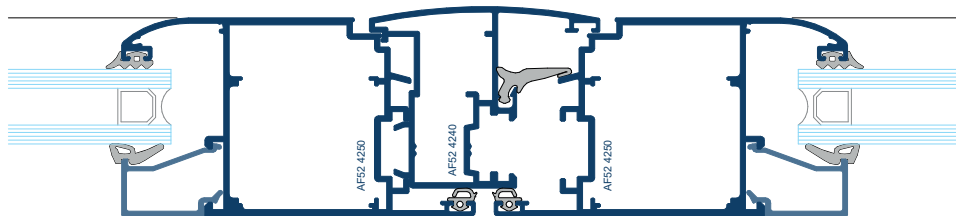
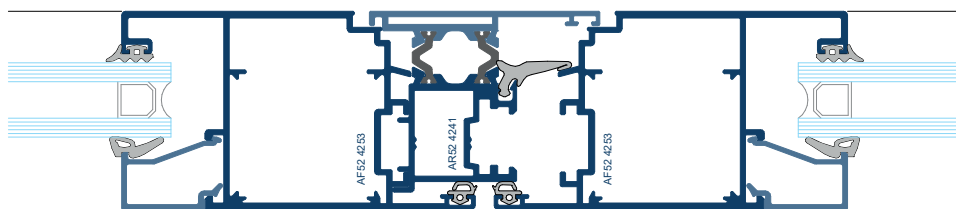
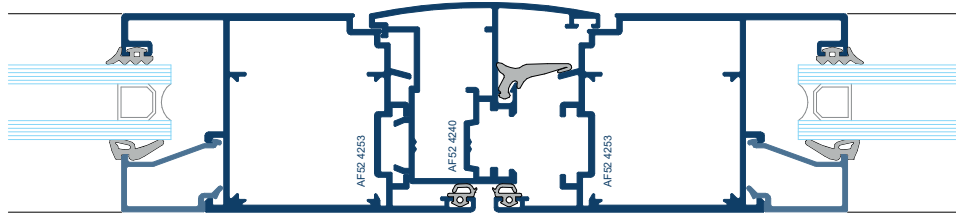

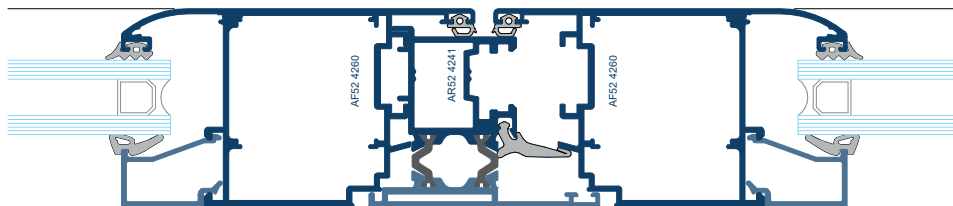
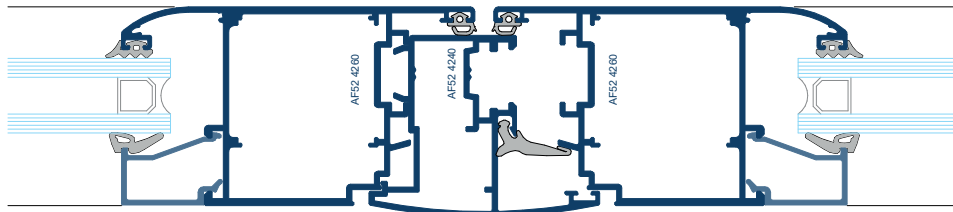
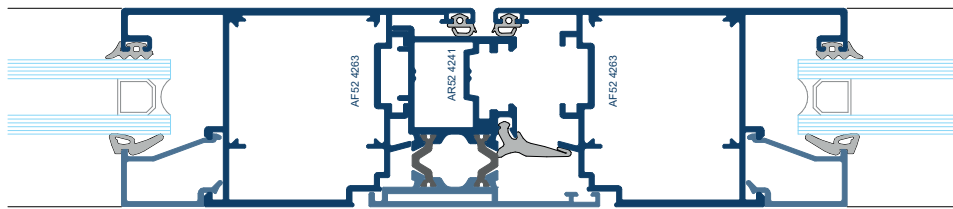
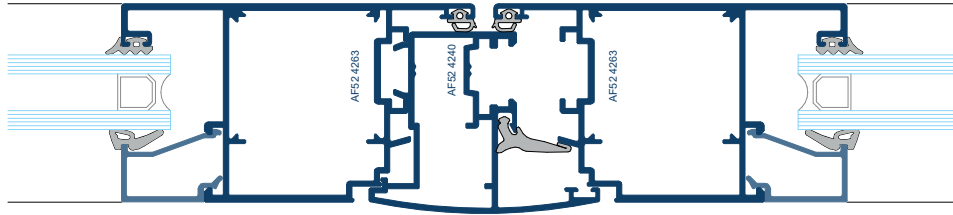

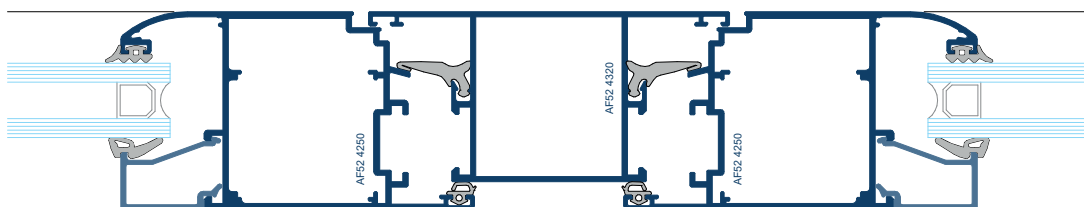
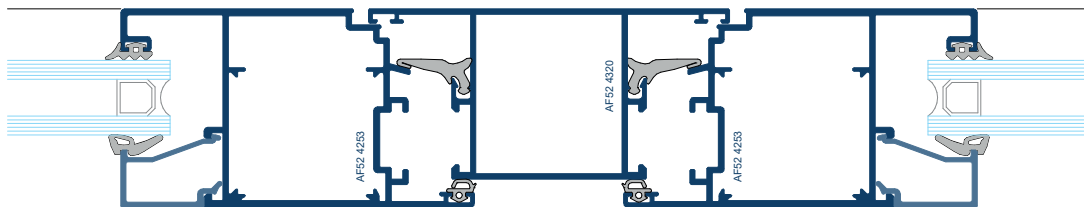
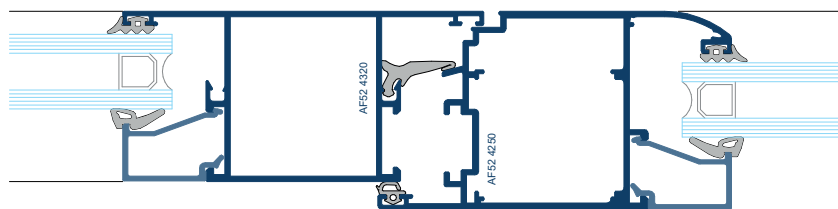
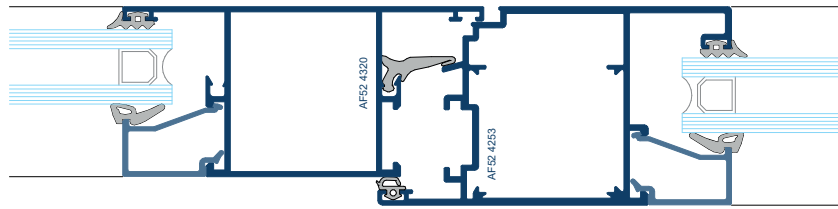

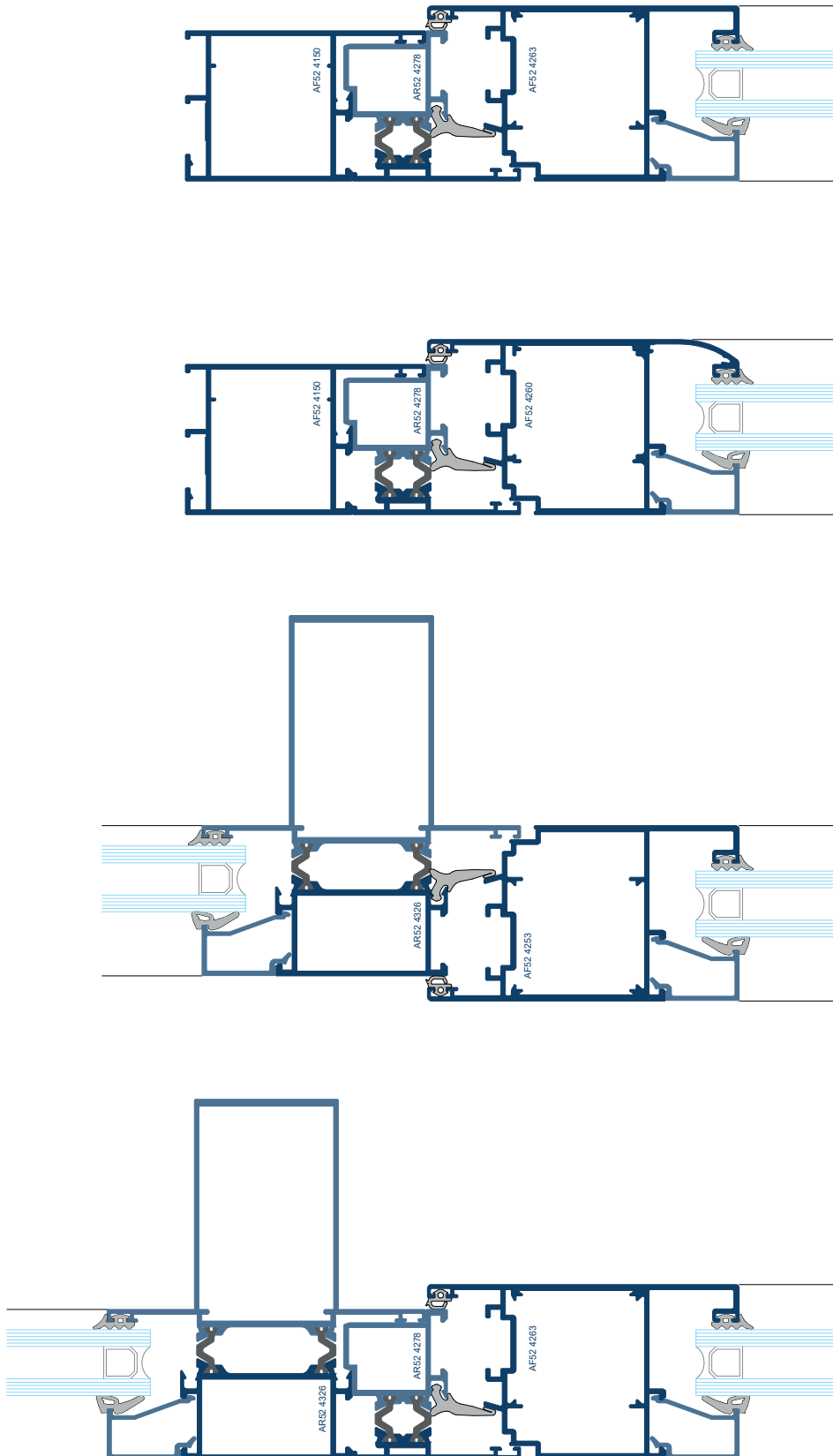

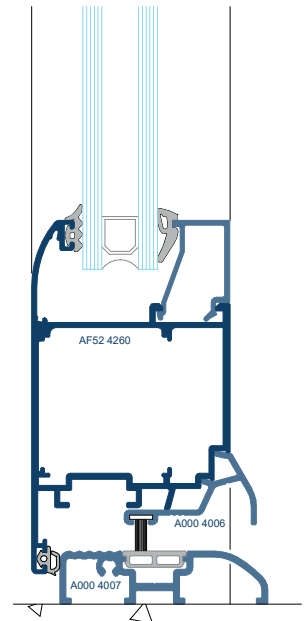
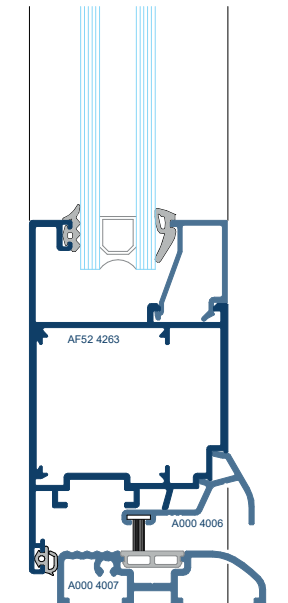
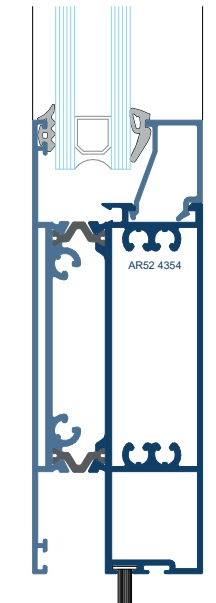
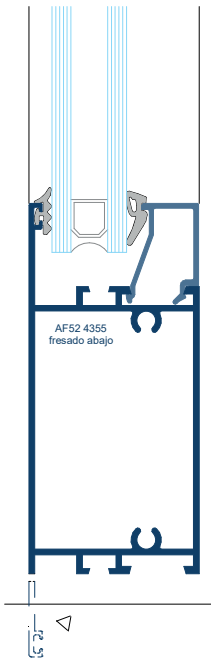
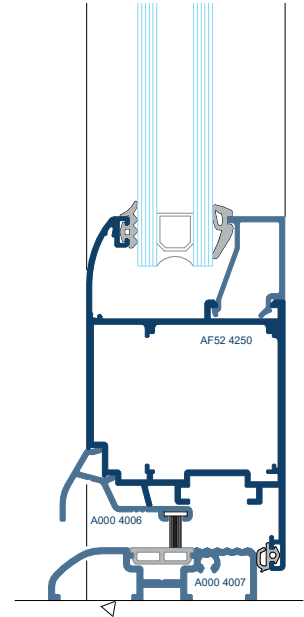
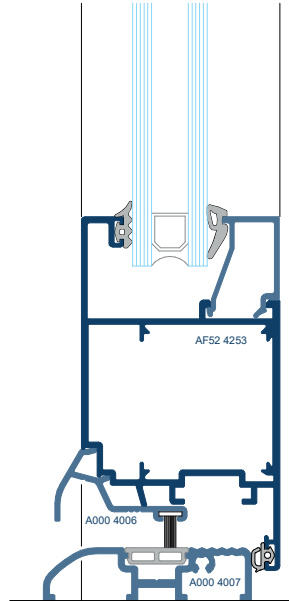
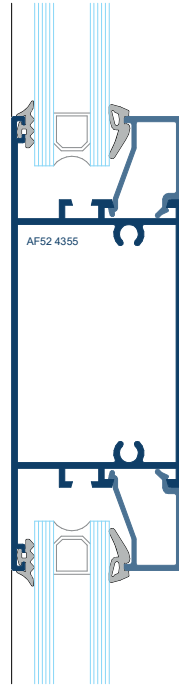

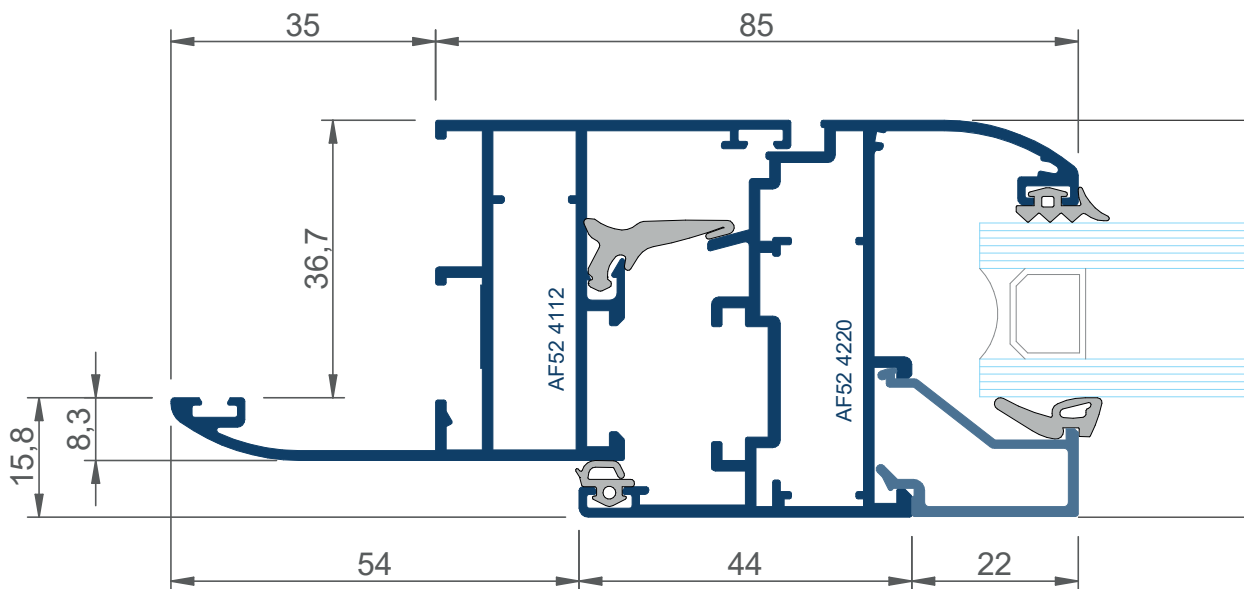
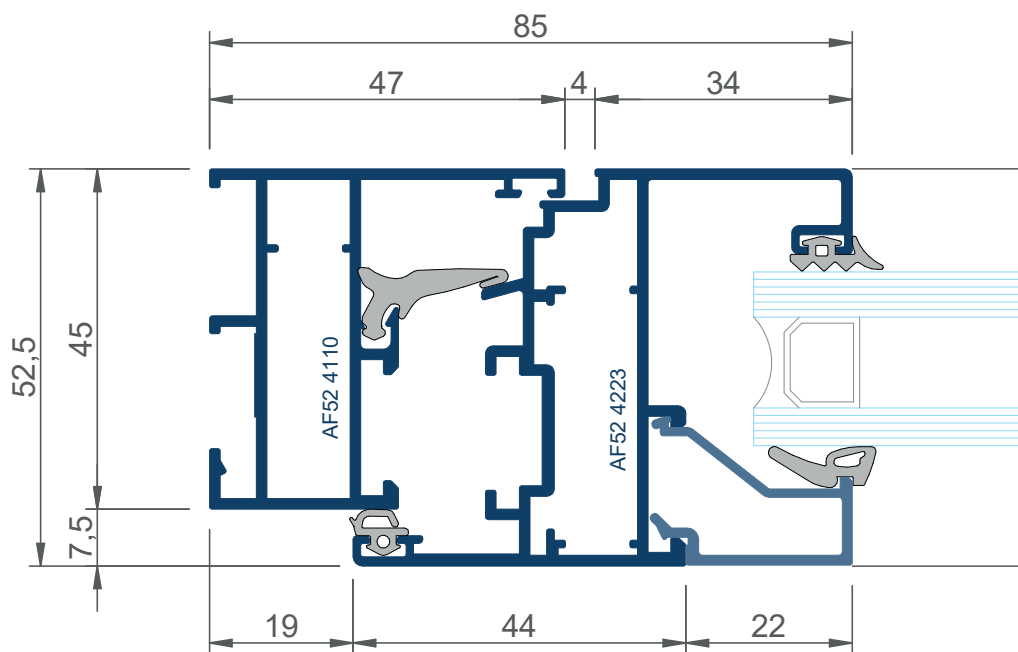

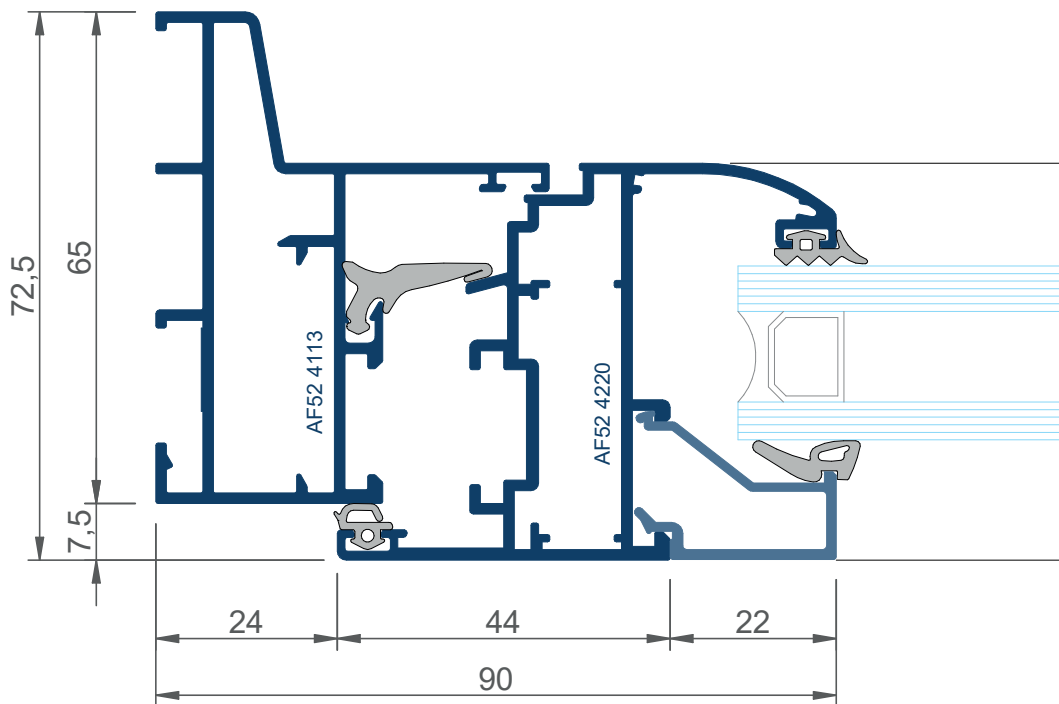
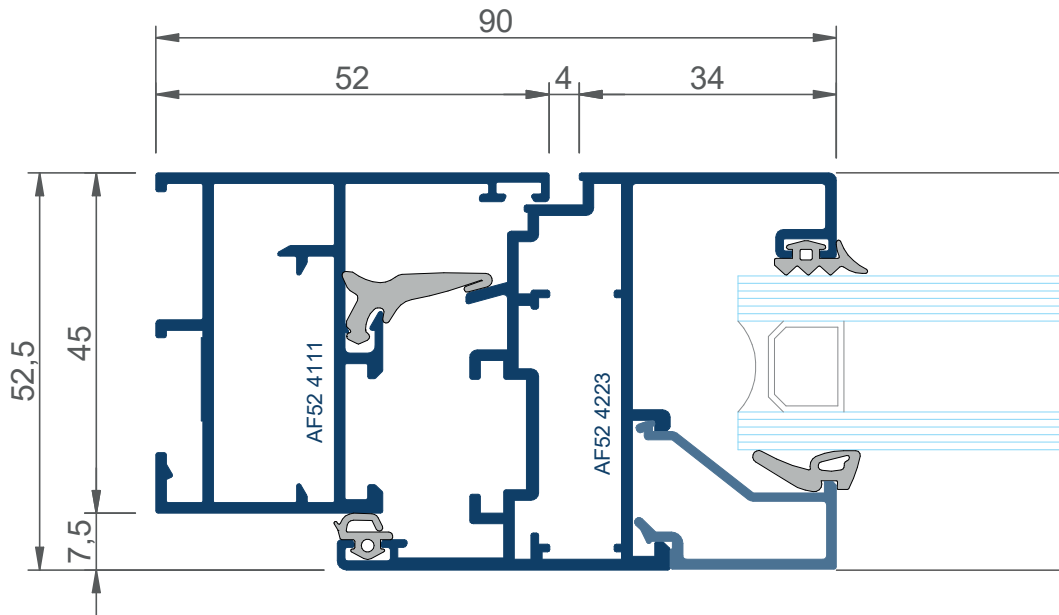

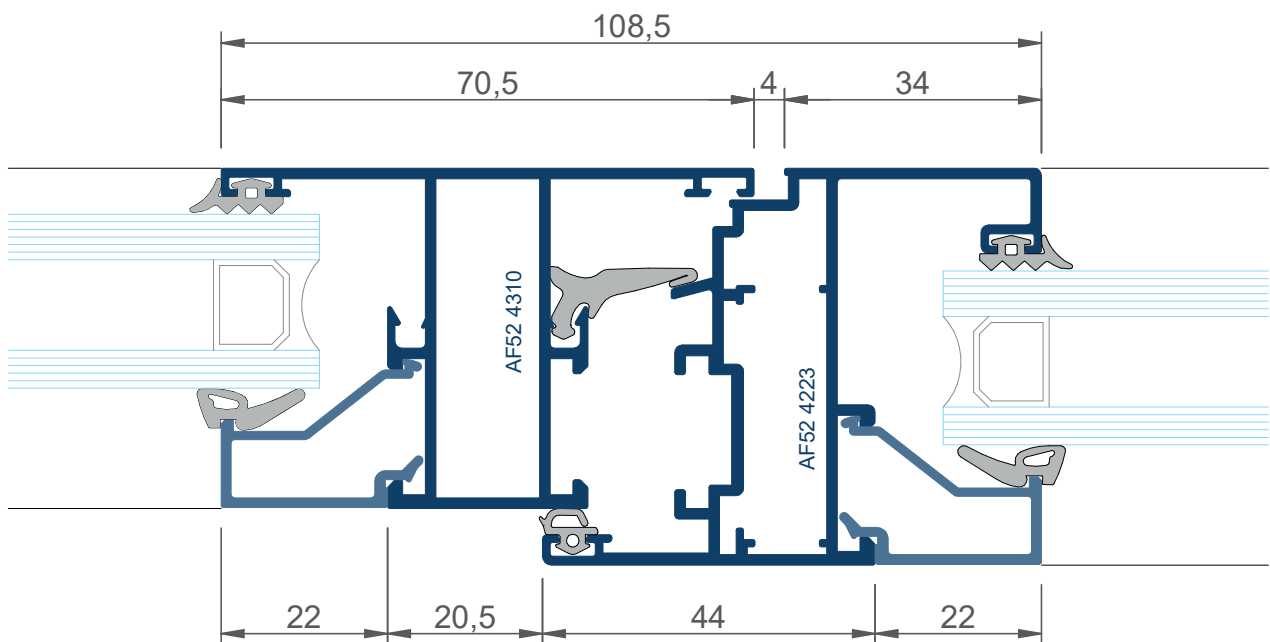
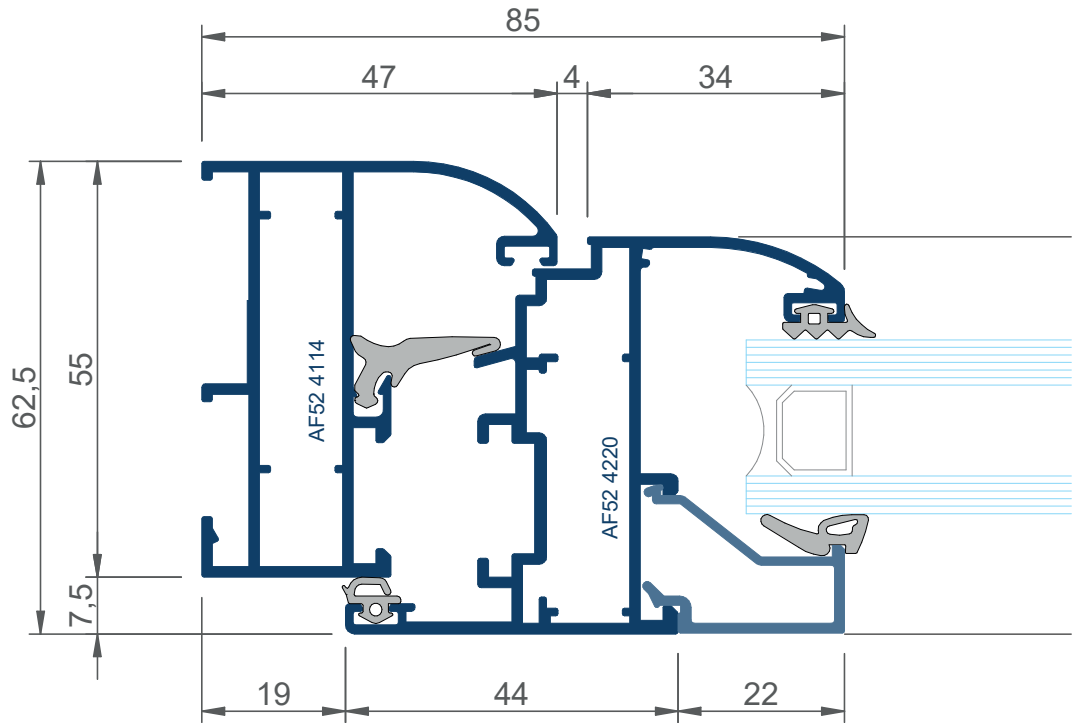

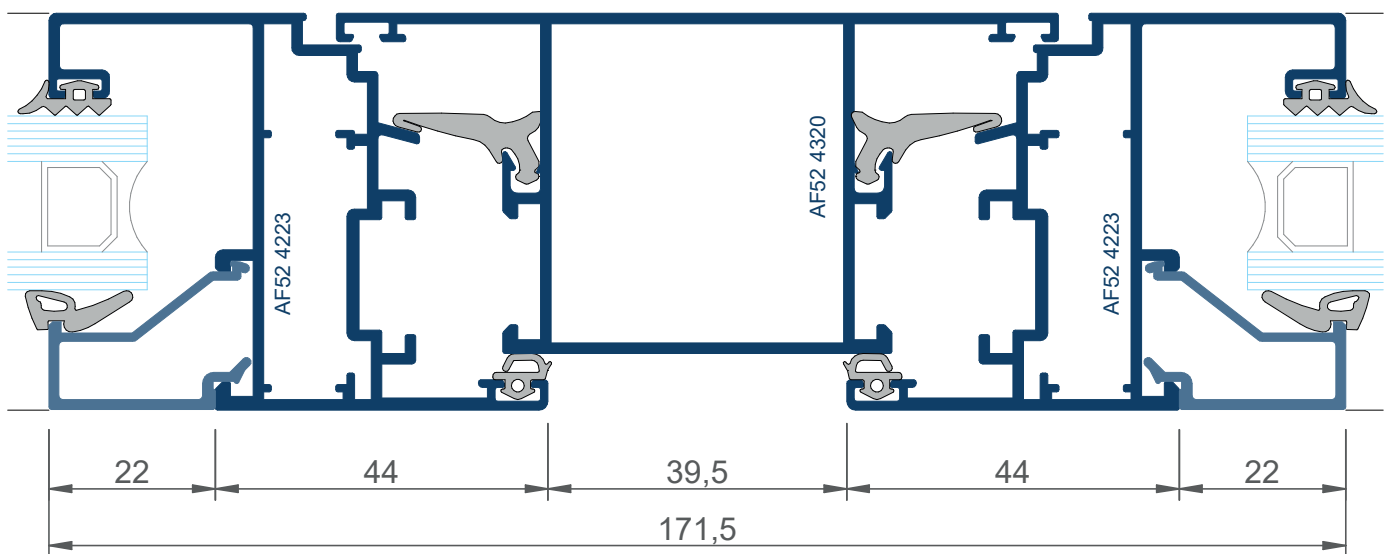
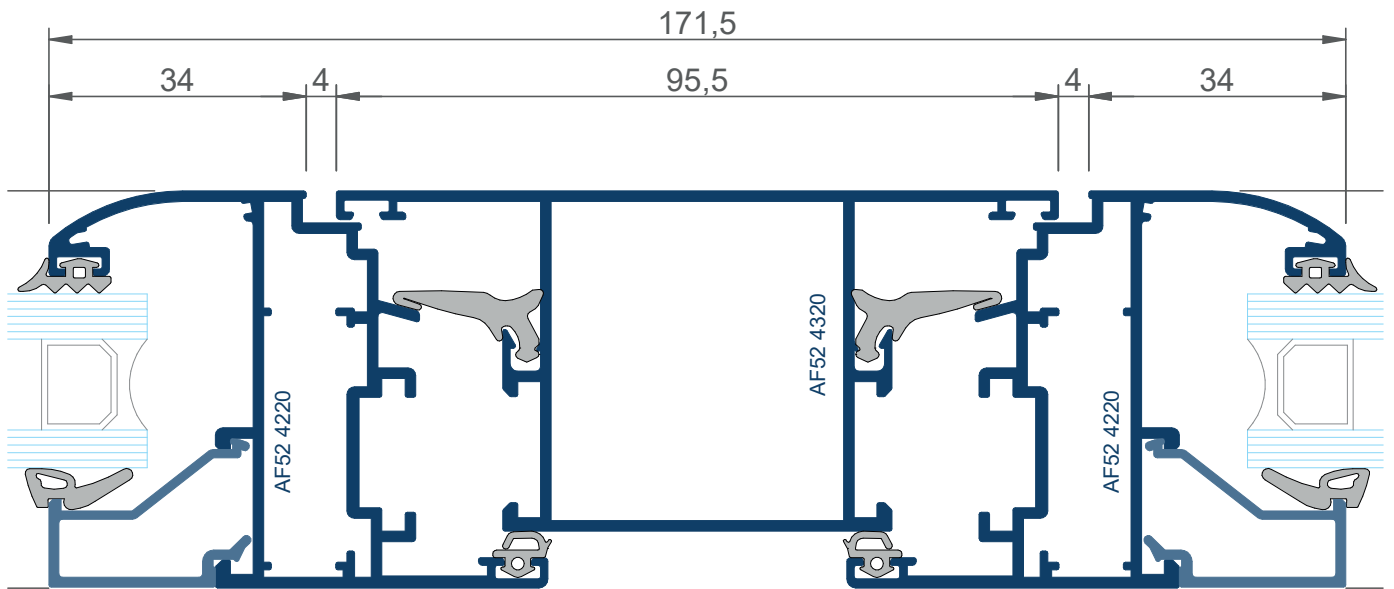

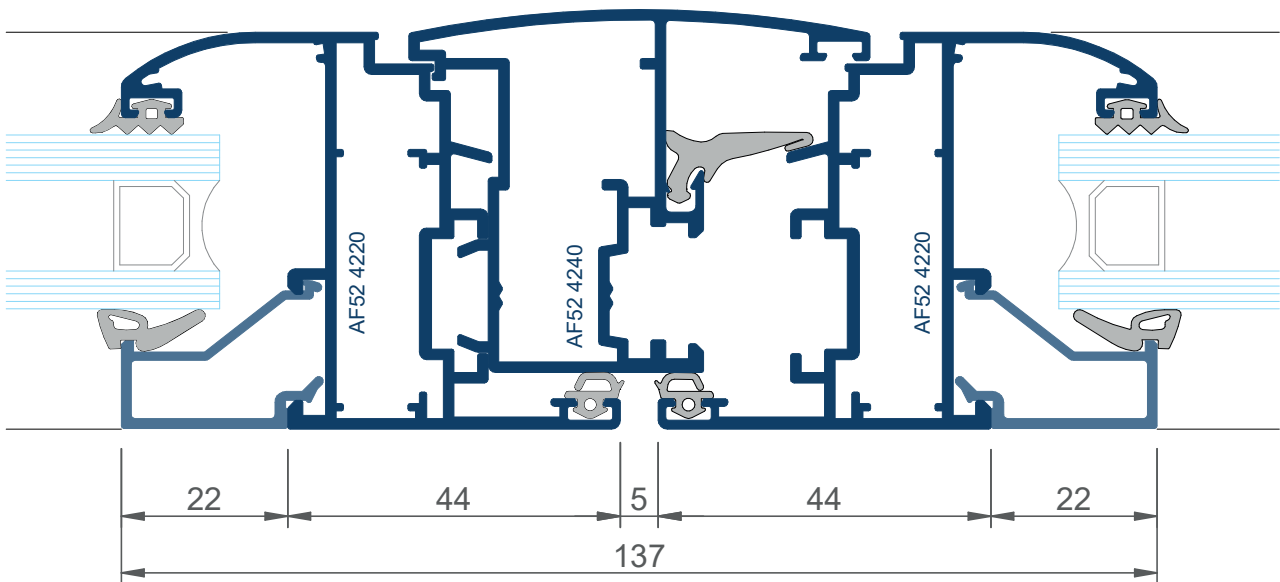
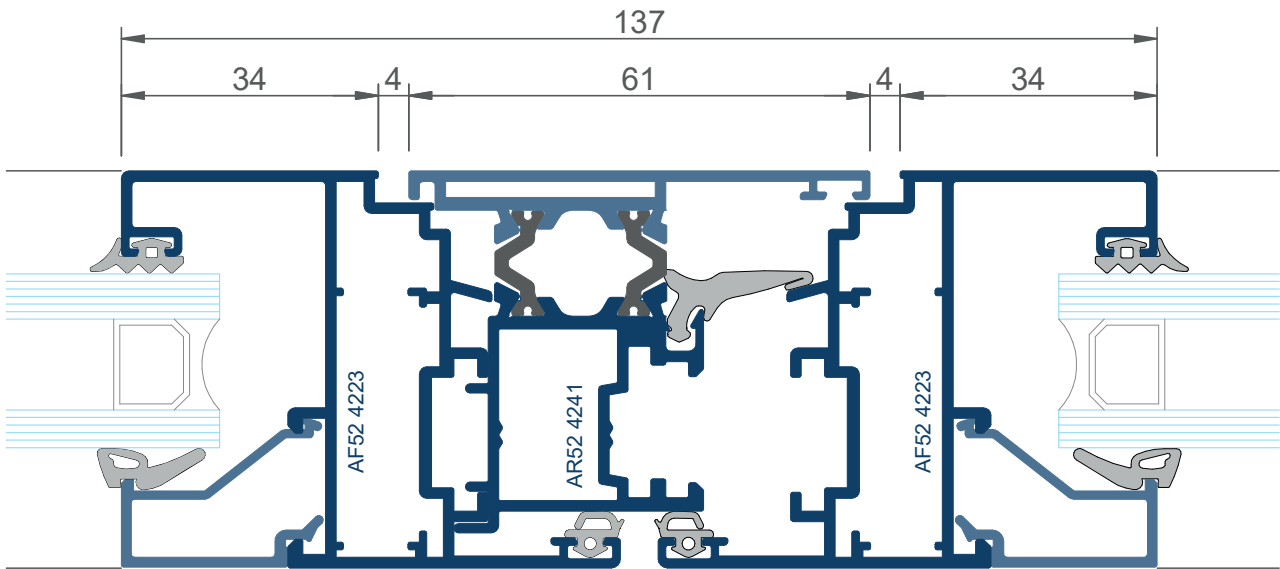

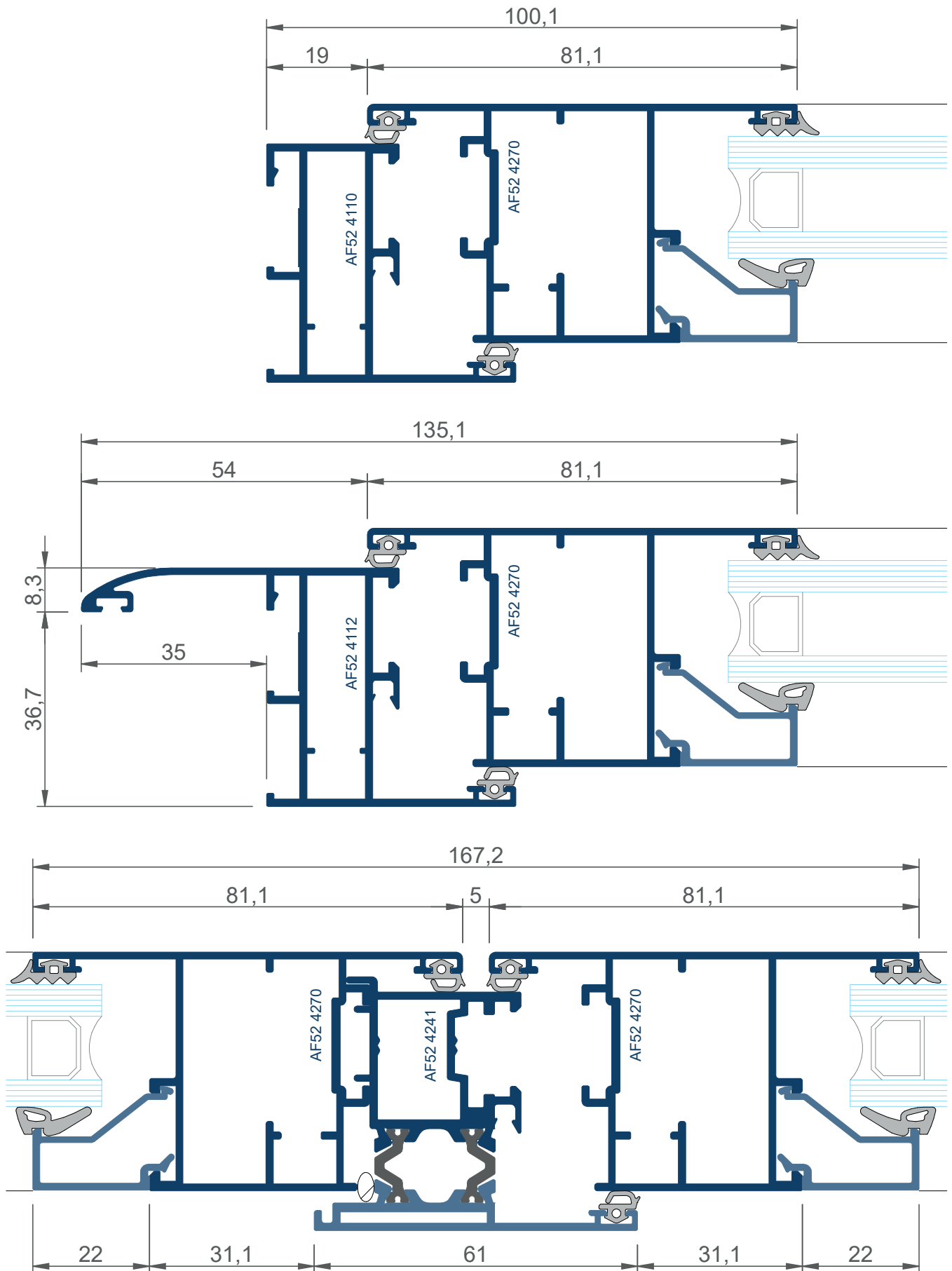

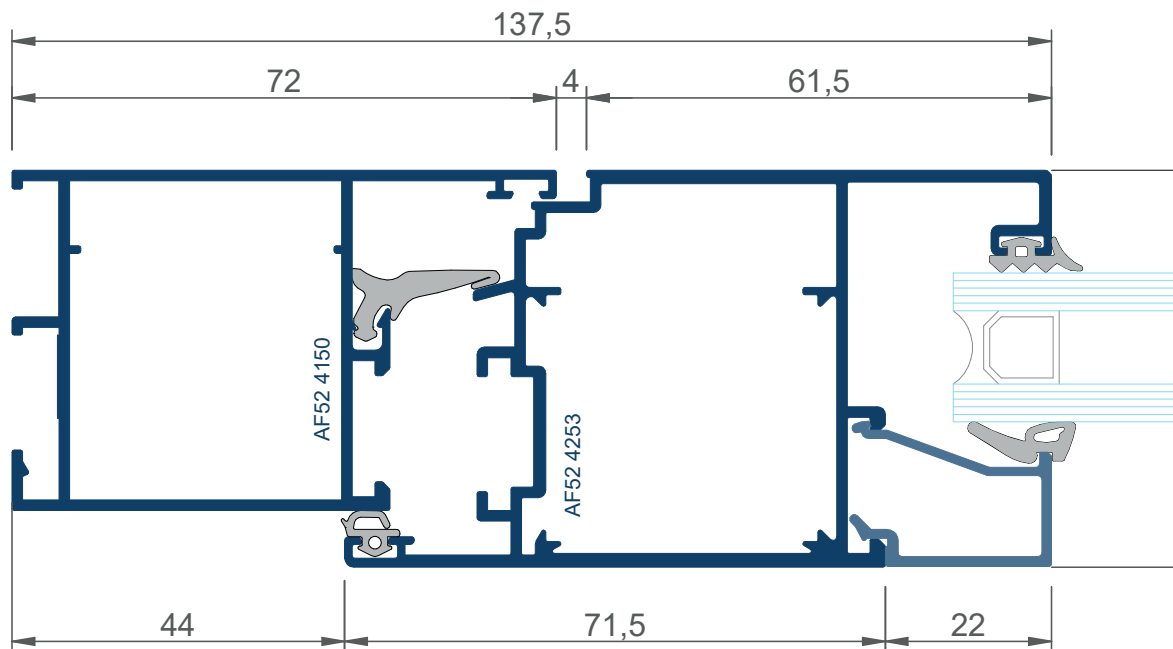
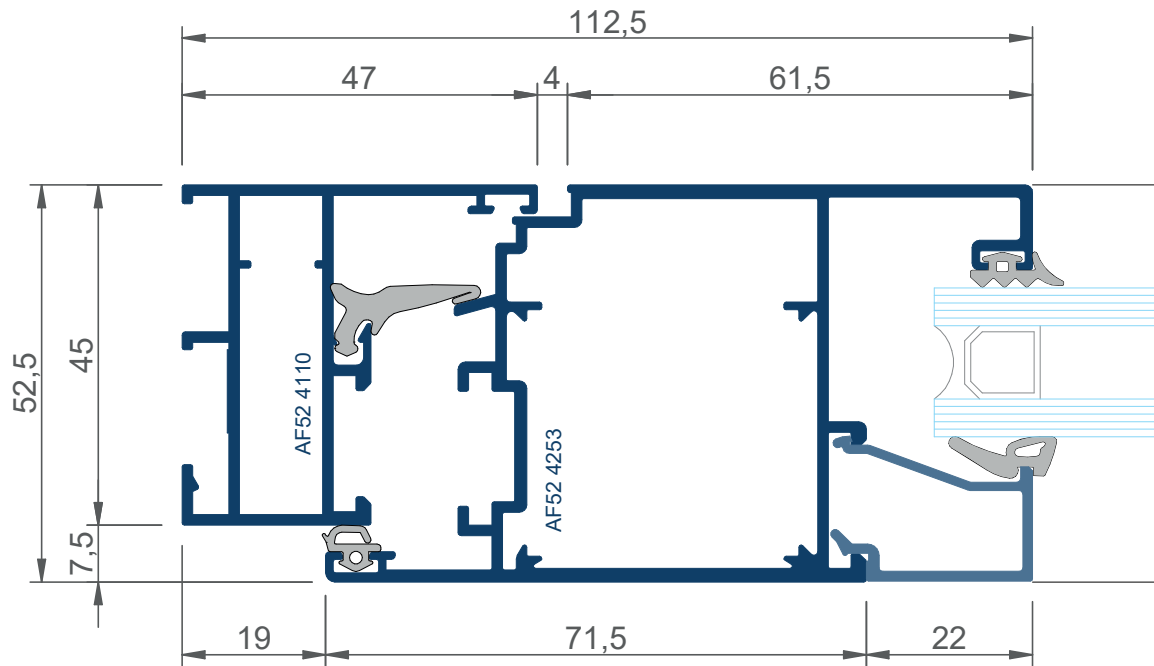

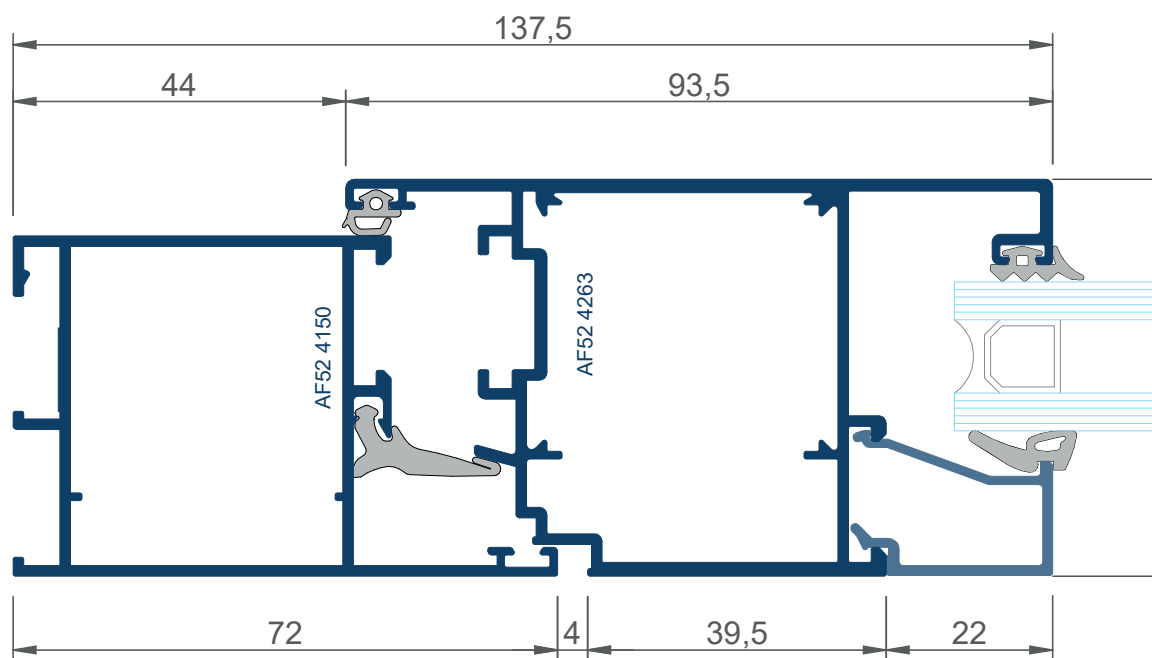
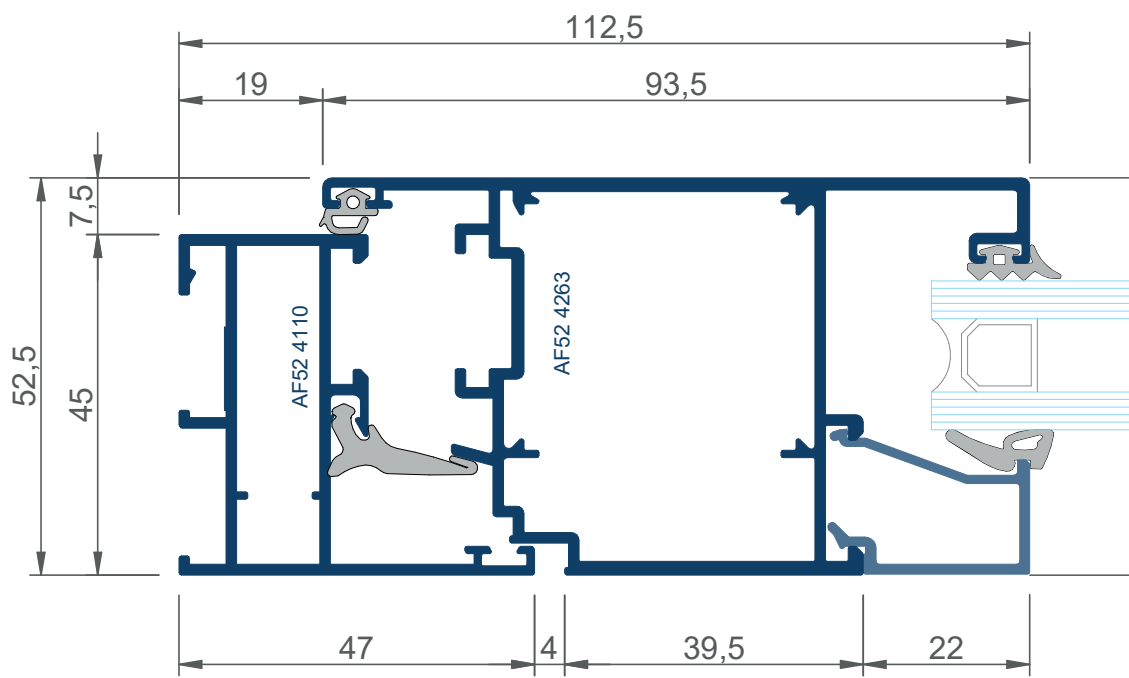

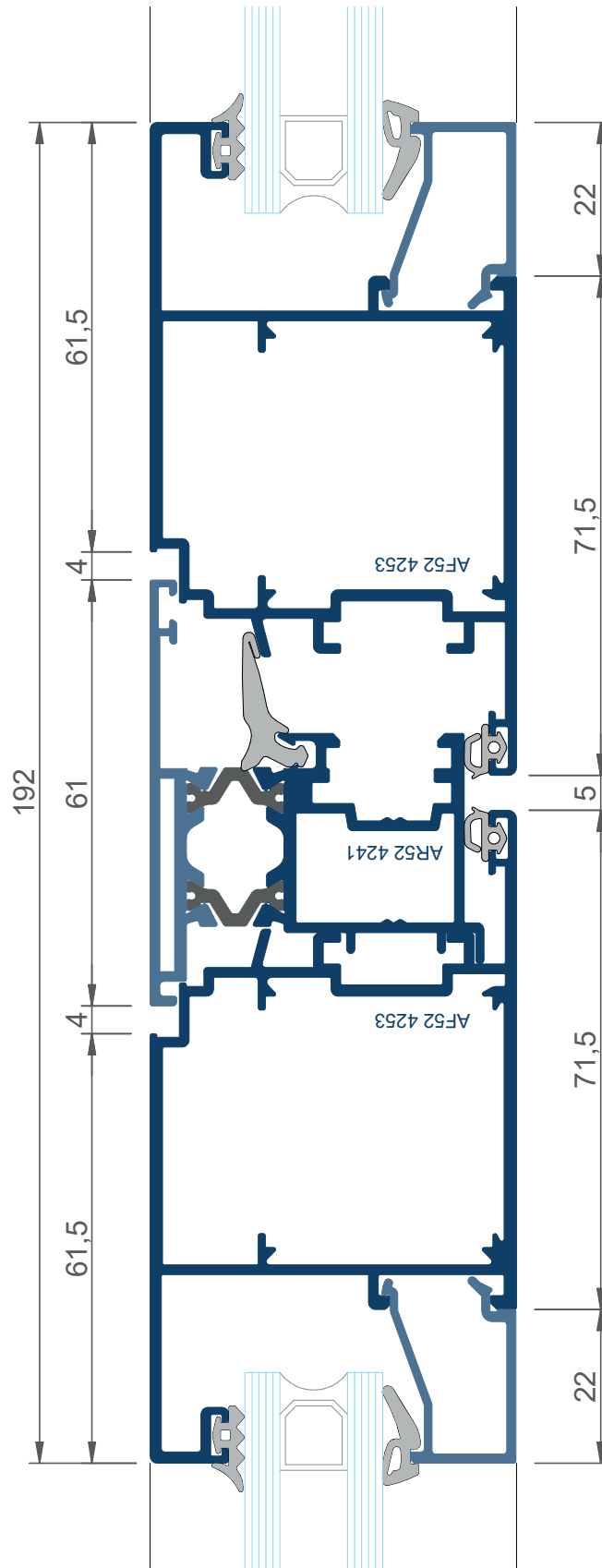

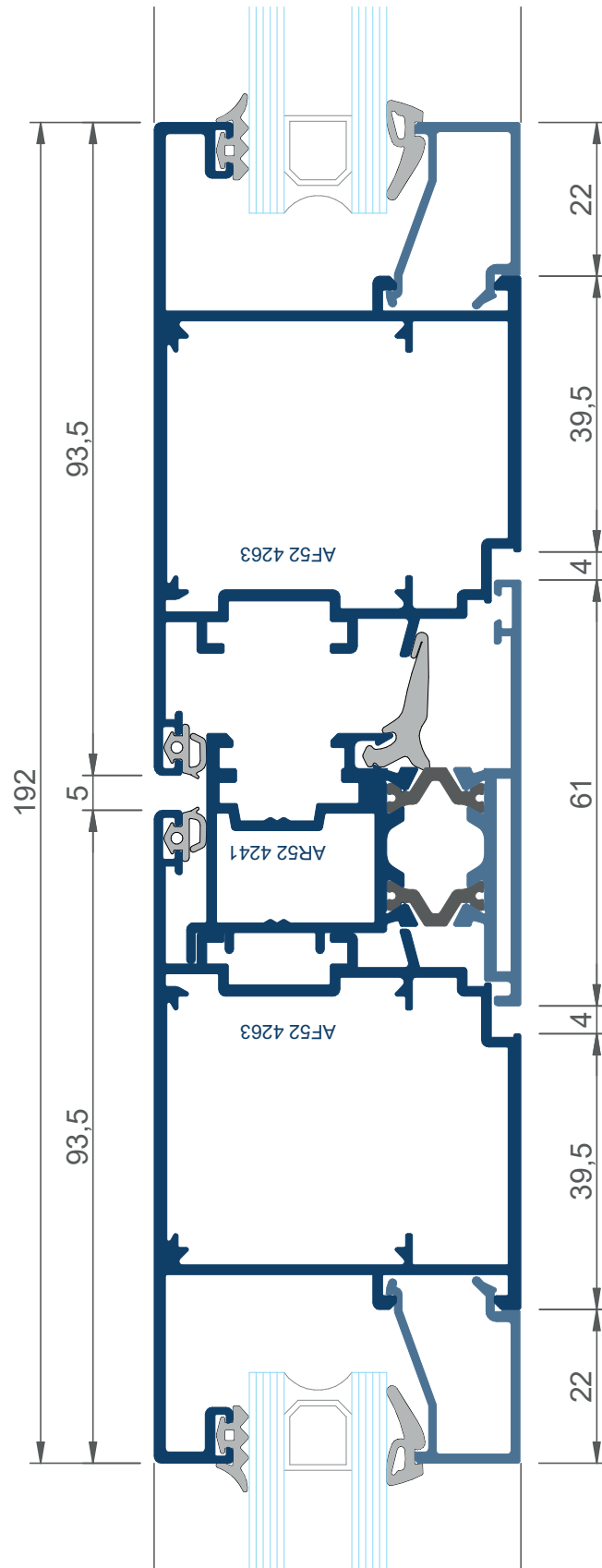

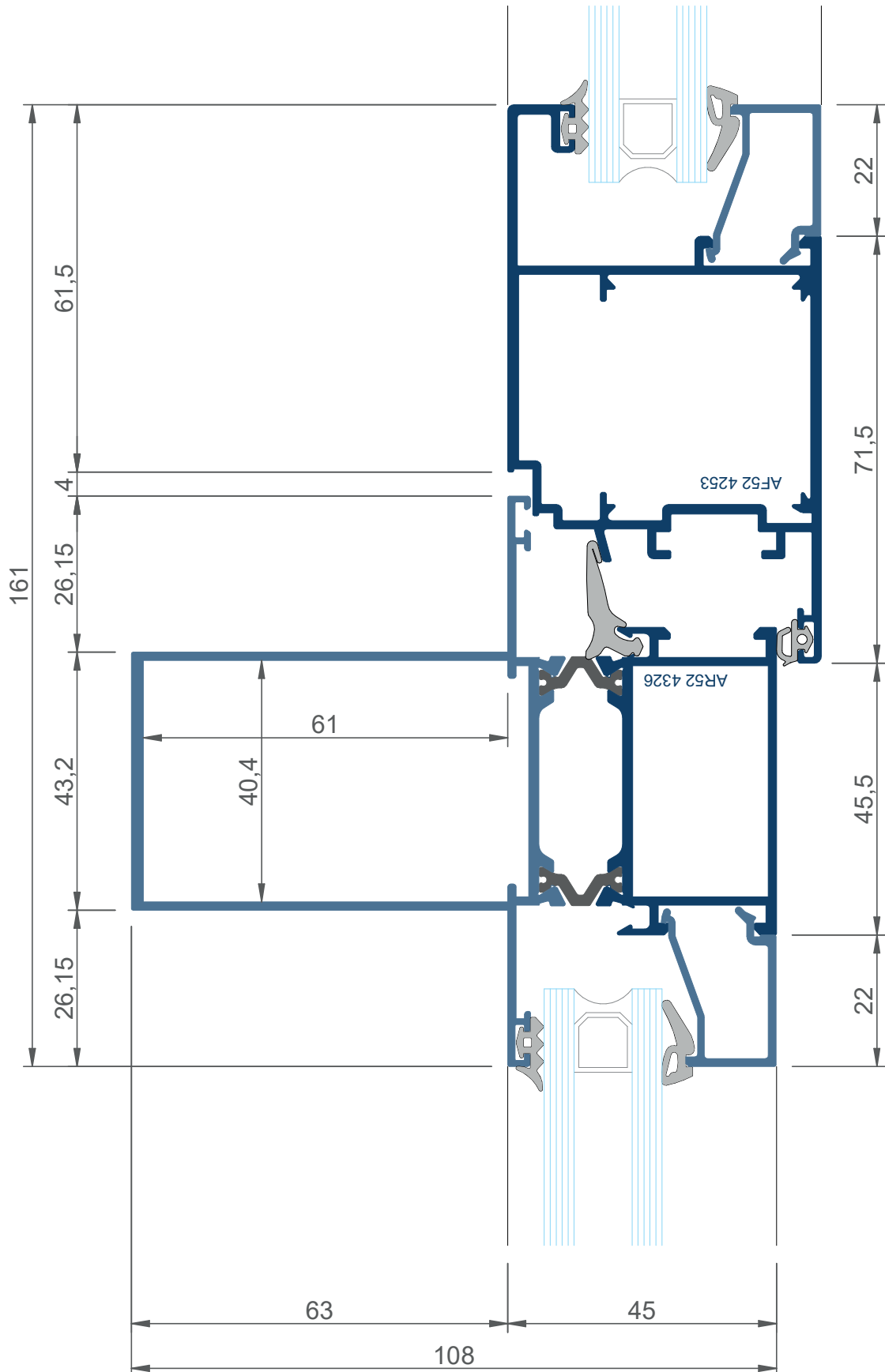

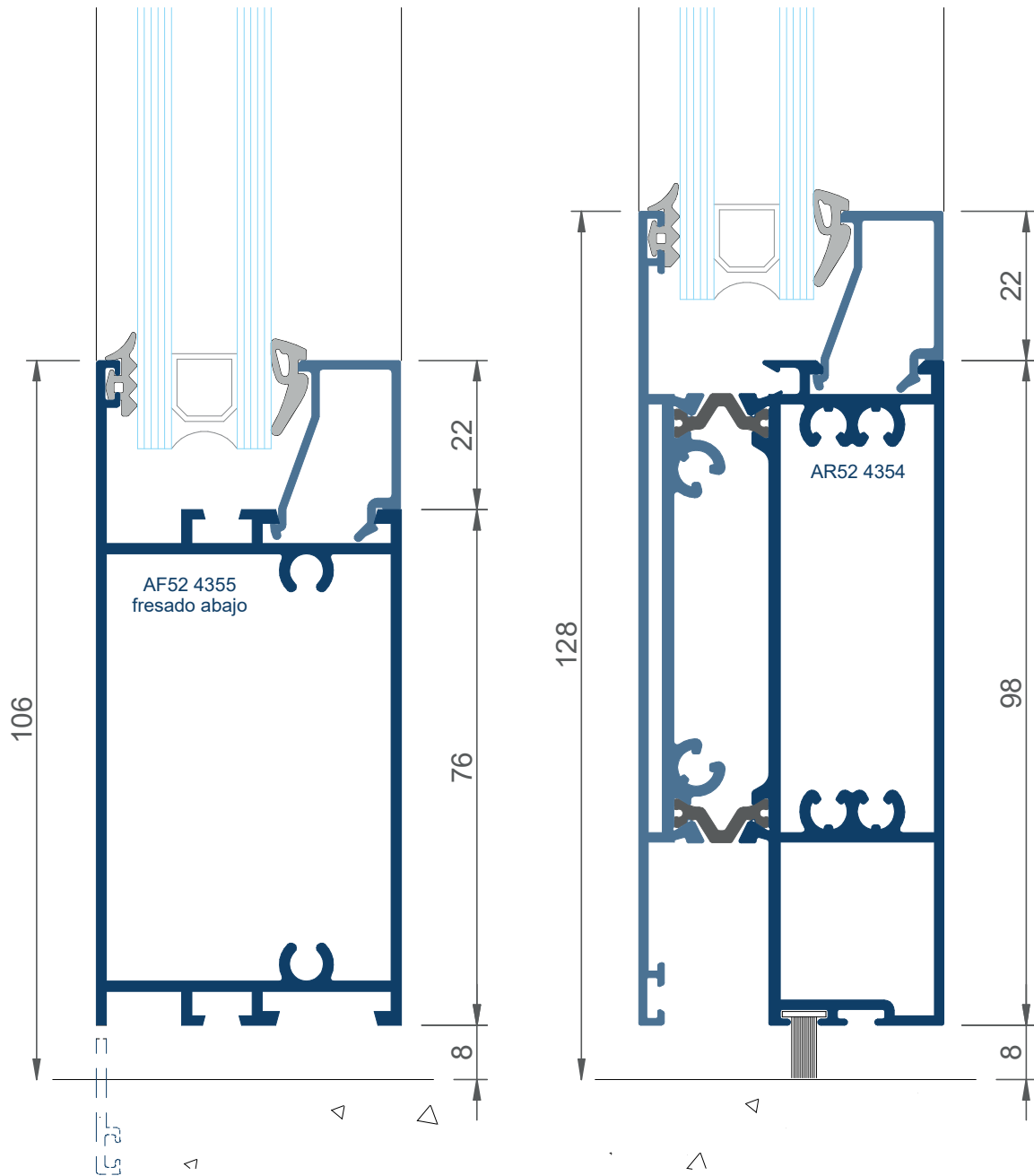

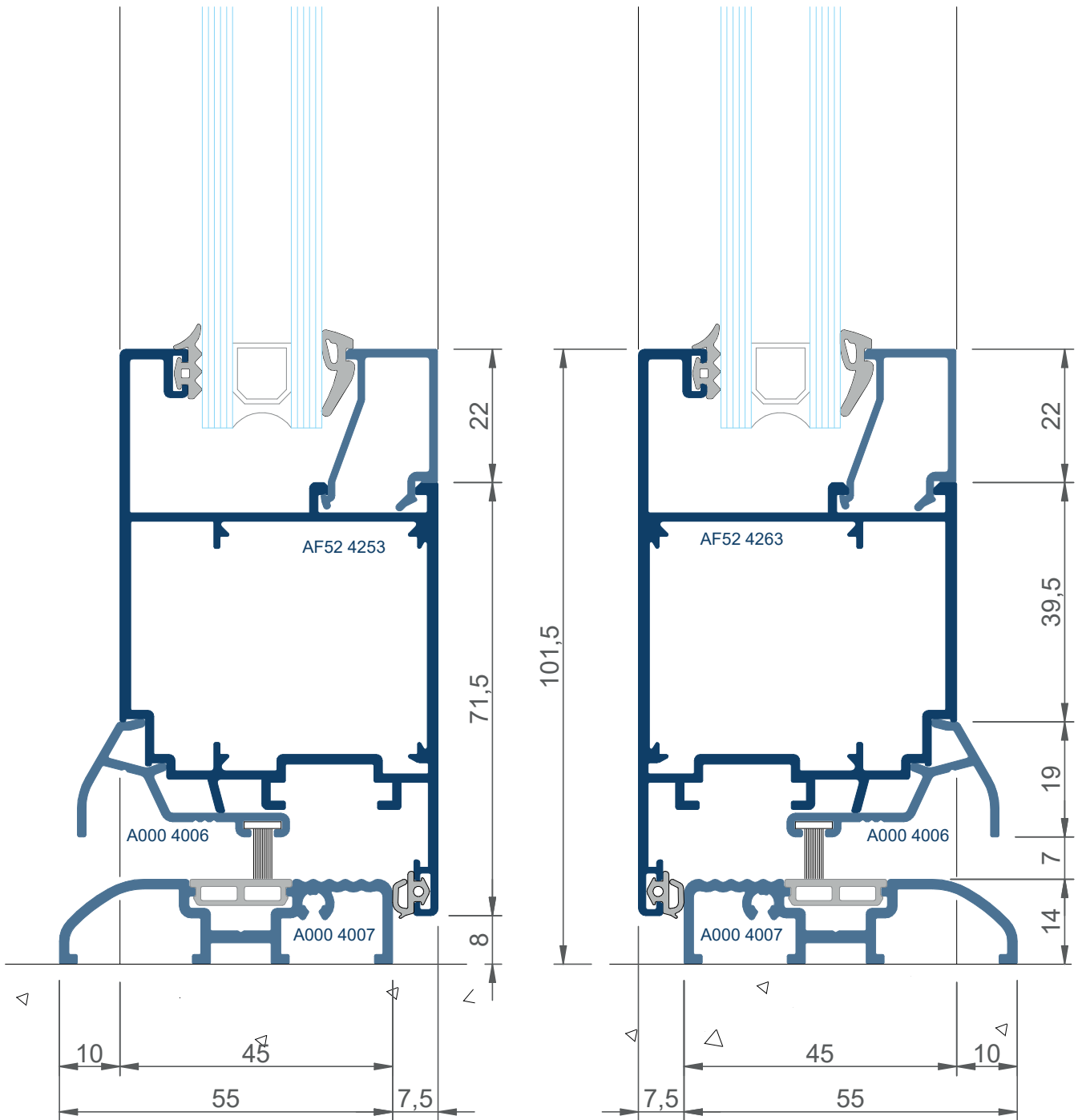

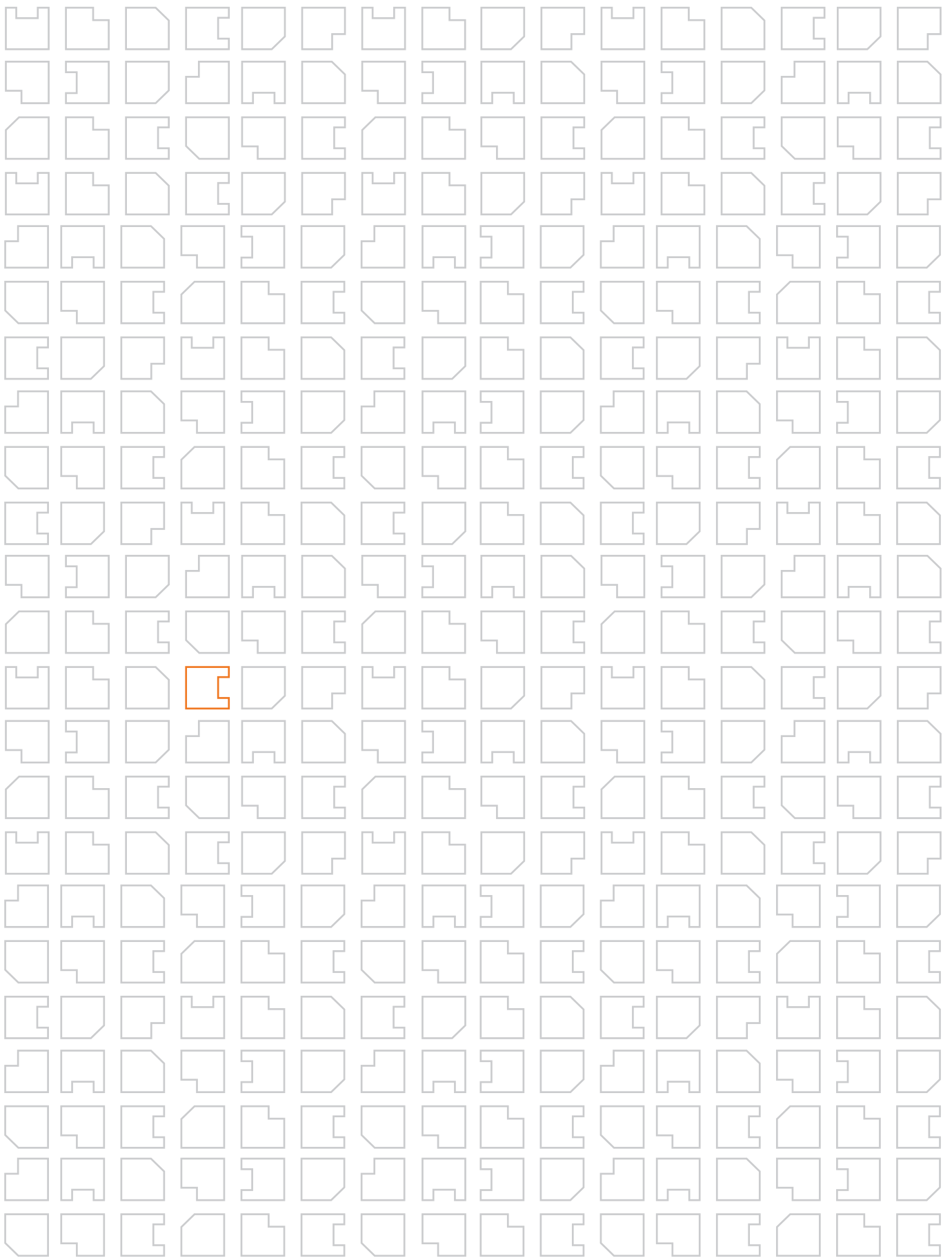

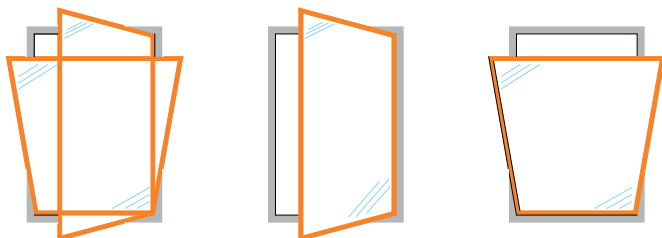

FORMULAS DE CORTE			
		UDS	FORMULA FORMA
marco horizontal	AF52.4110	2	B \---/
marco vertical	AF52.4110	2	H \---/
hoja horizontal	AF52.4223	2	B-39 \---/
hoja vertical	AF52.4223	2	H-39 \---/
junquillo recto horizontal	A000.XXXX	2	B-126 ---
junquillo eliptico horizontal	A000.XXXX	2	B-126 \---/
junquillo recto vertical	A000.XXXX	2	H-170 ---
junquillo eliptico vertical	A000.XXXX	2	H-126 \---/
vidrio	1		B-146 x H-146

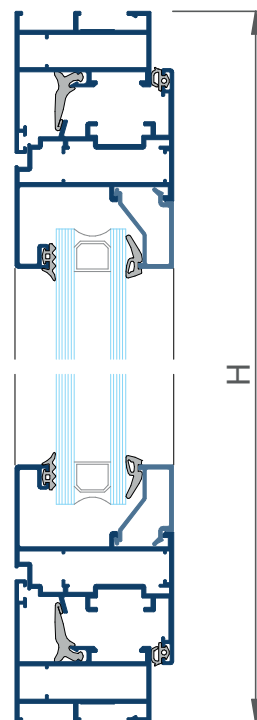

ACCESORIOS			UDS
escuadra	A000.2112		8
escuadra alineacion int hoja	A000.2132		4
deflector desagüe	A000.2301		2
junta central	A000.2310	2B+2H	
junta int hoja	A000.2320	2B+2H	
junta ext acristalamiento	A000.2351	2B+2H	
junta cuña int	A000.XXXX	2B+2H	

accesorios de maniobra no indicados (ver catalogo de maniobra)

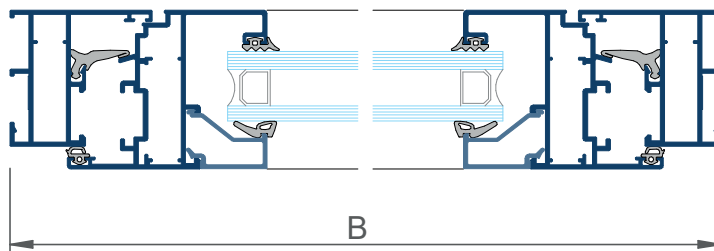

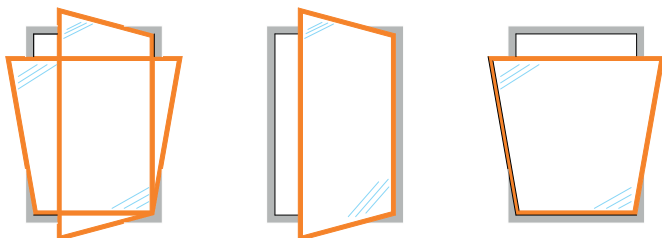

FORMULAS DE CORTE				
		UDS	FORMULA	FORMA
marco horizontal	AF52.4112	2	B+70	\---/
marco vertical	AF52.4112	2	H+70	\---/
hoja horizontal	AF52.4223	2	B-39	\---/
hoja vertical	AF52.4223	2	H-39	\---/
junquillo recto horizontal	A000.XXXX	2	B-126	---
junquillo eliptico horizontal	A000.XXXX	2	B-126	\---/
junquillo recto vertical	A000.XXXX	2	H-170	---
junquillo eliptico vertical	A000.XXXX	2	H-126	\---/
vidrio	1		B-146 x H-146	

ACCESORIOS			UDS
escuadra	A000.2112	8	
escuadra alineacion int hoja	A000.2132	4	
deflector desagüe	A000.2301	2	
junta central	A000.2310	2B+2H	
junta int hoja	A000.2320	2B+2H	
junta ext acristalamiento	A000.2351	2B+2H	
junta cuña int	A000.XXXX	2B+2H	

accesorios de maniobra no indicados (ver catalogo de maniobra)

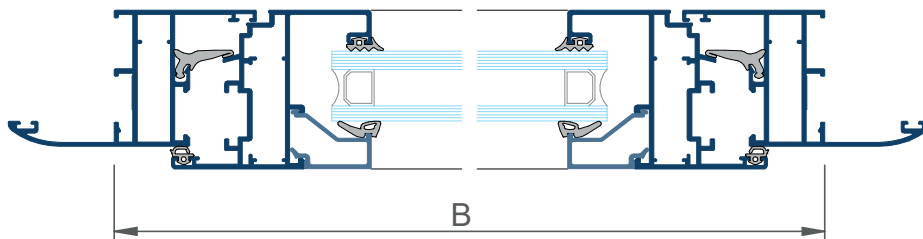
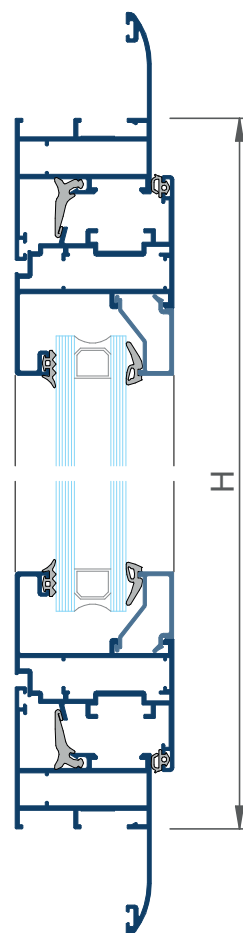

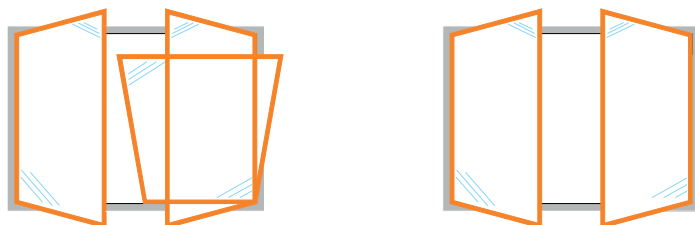

FORMULAS DE CORTE				
		UDS	FORMULA	FORMA
marco horizontal	AF52.4110	2	B	\ --- /
marco vertical	AF52.4110	2	H	\ --- /
hoja horizontal	AF52.4223	4	(B-44)/2	\ --- /
hoja vertical	AF52.4223	4	H-39	\ --- /
inversor doble hoja	AR52.4241	1	H-107	---
junquillo recto horizontal	A000.XXXX	4	(B-220)/2	---
junquillo eliptico horizontal	A000.XXXX	4	(B-220)/2	\ --- /
junquillo recto vertical	A000.XXXX	4	H-170	---
junquillo eliptico vertical	A000.XXXX	4	H-126	\ --- /
vidrio		2	(B-259)/2 x H-146	

ACCESORIOS		
		UDS
escuadra	A000.2112	12
escuadra alineacion int hoja	A000.2132	8
deflector desagüe	A000.2301	3
junta central	A000.2310	2B+3H
junta int hoja	A000.2320	2B+4H
junta ext acristalamiento	A000.2351	2B+4H
junta cuña int	A000.XXXX	2B+4H
juego tapas estanq central	A000.2340	1
juego tapas estética central	A000.2342	1

accesorios de maniobra no indicados (ver catalogo de maniobra)

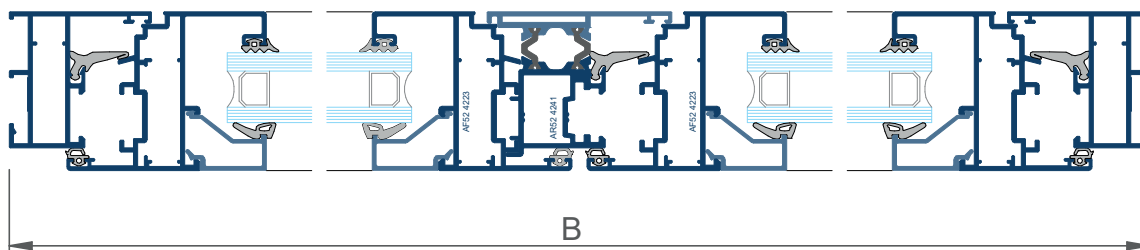
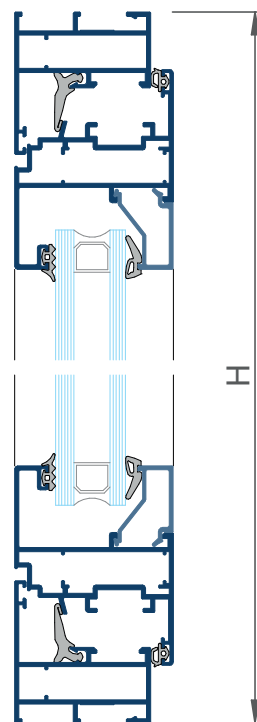

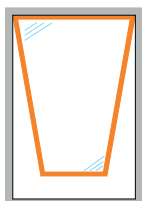

FORMULAS DE CORTE				
	UDS	FORMULA	FORMA	
marco horizontal	AF52.4110	2	B	\ --- /
marco vertical	AF52.4110	2	H	\ --- /
hoja horizontal	AF52.4270	2	B-39	\ --- /
hoja vertical	AF52.4270	2	H-39	\ --- /
junquillo recto horizontal	A000.XXXX	2	B-156	---
junquillo eliptico horizontal	A000.XXXX	2	B-156	\ --- /
junquillo recto vertical	A000.XXXX	2	H-200	---
junquillo eliptico vertical	A000.XXXX	2	H-156	\ --- /
vidrio	1	B-176 x H-176		

ACCESORIOS		
		UDS
escuadra	A000.2112	8
escuadra alineacion int hoja	A000.2132	4
junta int hoja	A000.2320	2B+2H
junta ext acristalamiento	A000.2351	2B+2H
junta cuña int	A000.XXXX	2B+2H

accesorios de maniobra no indicados (ver catalogo de maniobra)

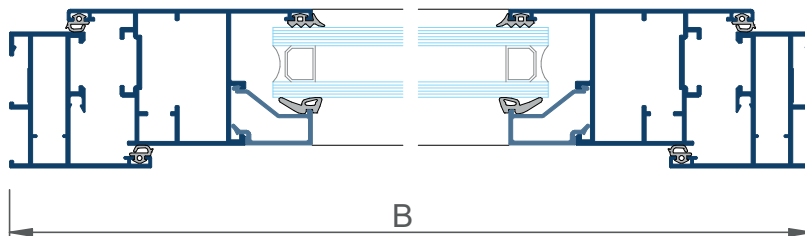
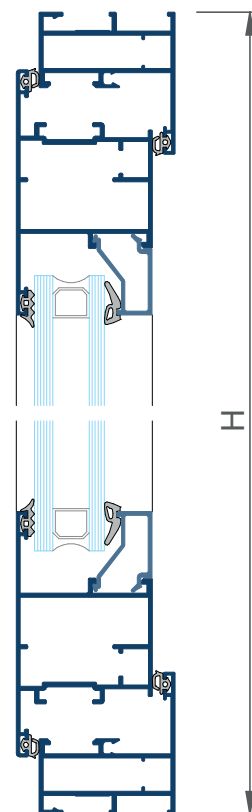

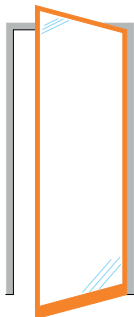

FORMULAS DE CORTE				
		UDS	FORMULA	FORMA
marco horizontal	AF52.4150	1	B	\ --- /
marco vertical	AF52.4150	2	H	--- / \ ---
hoja horizontal	AF52.4253	2	B-88	\ --- /
hoja vertical	AF52.4253	2	H-52	\ --- / \ --- /
perfil hoja bajo puerta	A000.4006	1	B-123	---
perfil umbral bajo puerta	A000.4007	1	B-91	---
junquillo recto horizontal	A000.XXXX	2	B-231	---
junquillo eliptico horizontal	A000.XXXX	2	B-231	\ --- /
junquillo recto vertical	A000.XXXX	2	H-239	---
junquillo eliptico vertical	A000.XXXX	2	H-195	\ --- /

vidrio 1 B-249 x H-213

ACCESORIOS		
		UDS
escuadra marco y hoja	A000.2116	6
escuadra alineacion int hoja	A000.2132	4
junta central	A000.2310	1B+2H
junta int hoja	A000.2320	2B+2H
junta ext acristalamiento	A000.2351	2B+2H
junta cuña int	A000.XXXX	2B+2H
junta bajo puerta	CF31.2352	1B

accesorios de maniobra no indicados (ver catalogo de maniobra)

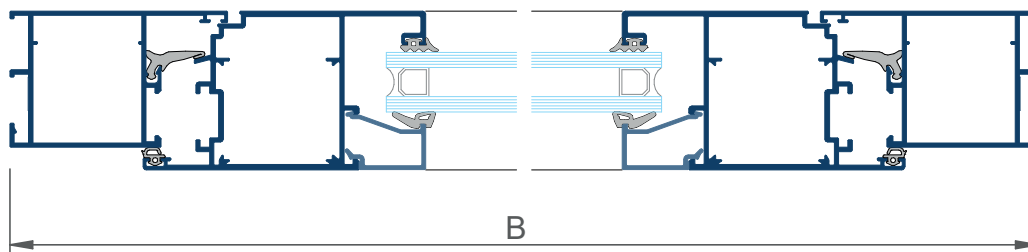
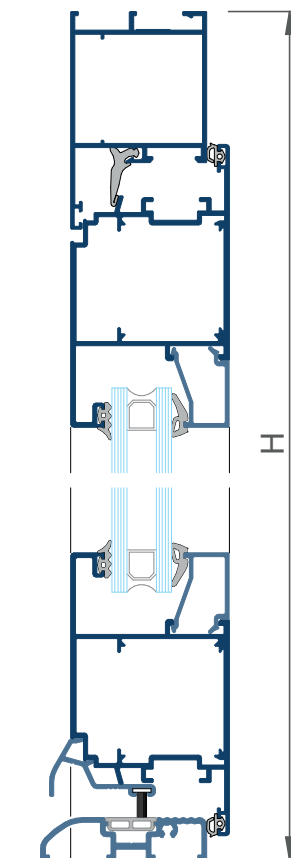

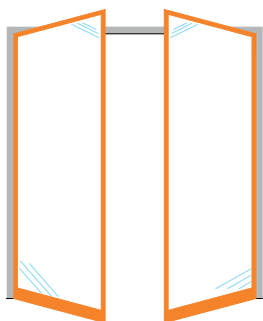

FORMULAS DE CORTE				
		UDS	FORMULA	FORMA
marco horizontal	AF52.4150	1	B	\ --- /
marco vertical	AF52.4150	2	H	--- / \ ---
hoja horizontal	AF52.4253	4	(B-93)/2	\ --- /
hoja vertical	AF52.4253	4	H-52	\ --- /
inversor doble hoja	AR52.4241	1	H-120	---
perfil hoja bajo puerta	A000.4006	1	(B-163)/2	---
perfil hoja bajo puerta	A000.4006	1	(B-92)/2	---
perfil umbral bajo puerta	A000.4007	1	B-91	---
junquillo recto horizontal	A000.XXXX	4	(B-379)/2	---
junquillo eliptico horizontal	A000.XXXX	4	(B-379)/2	\ --- /
junquillo recto vertical	A000.XXXX	4	H-239	---
junquillo eliptico vertical	A000.XXXX	4	H-195	\ --- /

vidrio 2 (B-415)/2 x H-213

ACCESORIOS		
		UDS
escuadra marco y hoja	A000.2116	10
escuadra alineacion int hoja	A000.2132	8
juego tapas estanquidad central	A000.2340	1
juego tapas estética central	A000.2342	1
junta central	A000.2310	1B+3H
junta int hoja	A000.2320	2B+4H
junta ext acristalamiento	A000.2351	2B+4H
junta cuña int	A000.XXXX	2B+4H
junta bajo puerta	CF31.2352	1B

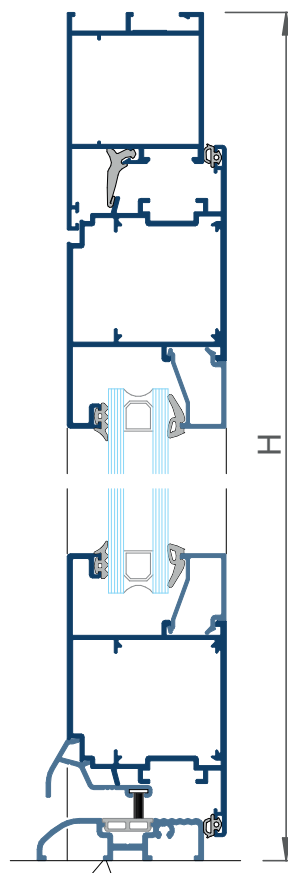

accesorios de maniobra no indicados (ver catalogo de maniobra)

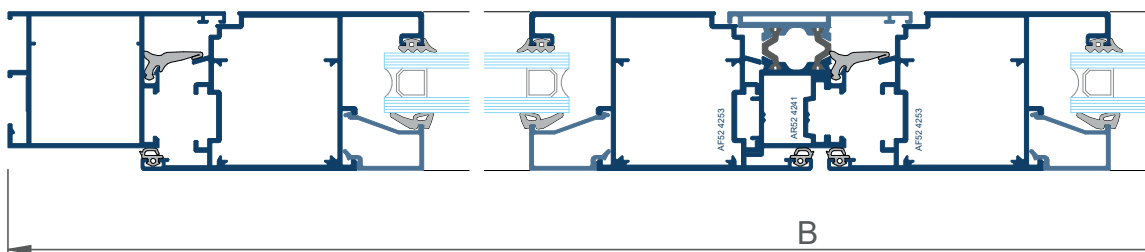

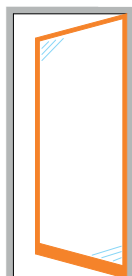

FORMULAS DE CORTE				
		UDS	FORMULA	FORMA
marco horizontal	AF52.4150	1	B	\ --- /
marco vertical	AF52.4150	2	H	--- / \ ---
hoja horizontal	AF52.4263	2	B-88	\ --- /
hoja vertical	AF52.4263	2	H-52	\ --- /
perfil hoja bajo puerta	A000.4006	1	B-123	---
perfil umbral bajo puerta	A000.4007	1	B-91	---
junquillo recto horizontal	A000.XXXX	2	B-231	---
junquillo eliptico horizontal	A000.XXXX	2	B-231	\ --- /
junquillo recto vertical	A000.XXXX	2	H-239	---
junquillo eliptico vertical	A000.XXXX	2	H-195	\ --- /

vidrio 1 B-249 x H-213

ACCESORIOS			UDS
escuadra marco y hoja	A000.2116		6
escuadra alineacion int hoja	A000.2132		4
junta central	A000.2310		1B+2H
junta int hoja	A000.2320		2B+2H
junta ext acristalamiento	A000.2351		2B+2H
junta cuña int	A000.XXXX		2B+2H
junta bajo puerta	CF31.2352		1B

accesorios de maniobra no indicados (ver catalogo de maniobra)

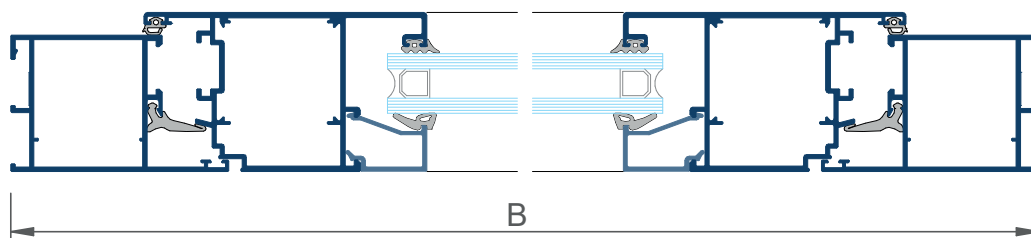
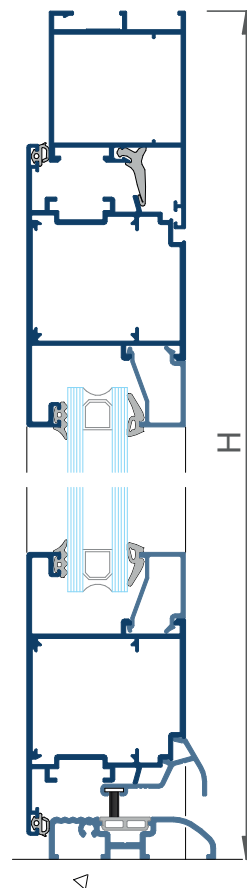

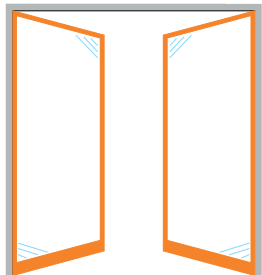

FORMULAS DE CORTE			
	UDS	FORMULA	FORMA
marco horizontal	AF52.4150	1 B	\ --- /
marco vertical	AF52.4150	2 H	--- / \ ---
hoja horizontal	AF52.4263	4 (B-93)/2	\ --- /
hoja vertical	AF52.4263	4 H-52	\ --- /
inversor doble hoja	AR52.4241	1 H-120	---
perfil hoja bajo puerta	A000.4006	1 (B-163)/2	---
perfil hoja bajo puerta	A000.4006	1 (B-92)/2	---
perfil umbral bajo puerta	A000.4007	1 B-91	---
junquillo recto horizontal	A000.XXXX	4 (B-379)/2	---
junquillo eliptico horizontal	A000.XXXX	4 (B-379)/2	\ --- /
junquillo recto vertical	A000.XXXX	4 H-239	---
junquillo eliptico vertical	A000.XXXX	4 H-195	\ --- /
vidrio	2	(B-415)/2 x H-213	

ACCESORIOS		
		UDS
escuadra marco y hoja	A000.2116	10
escuadra alineacion int hoja	A000.2132	8
juego tapas estanquidad central	A000.2340	1
juego tapas estética central	A000.2342	1
junta central	A000.2310	1B+3H
junta int hoja	A000.2320	2B+4H
junta ext acristalamiento	A000.2351	2B+4H
junta cuña int	A000.XXXX	2B+4H
junta bajo puerta	CF31.2352	1B

accesorios de maniobra no indicados (ver catalogo de maniobra)

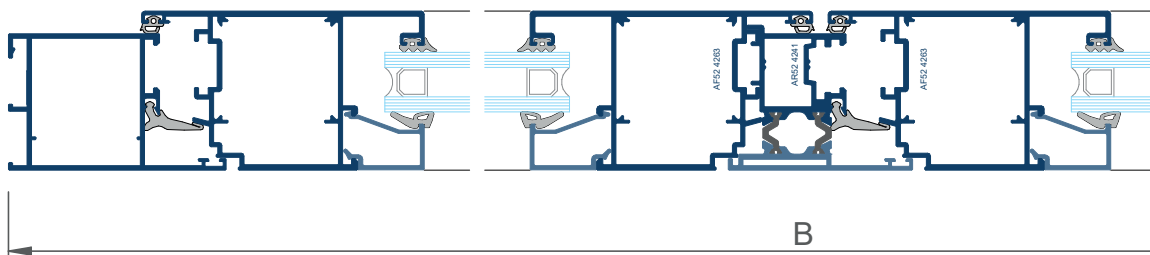
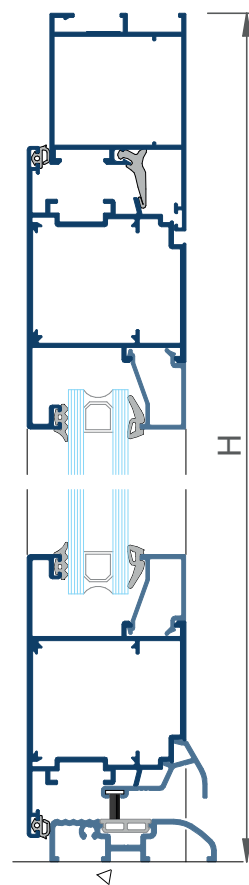

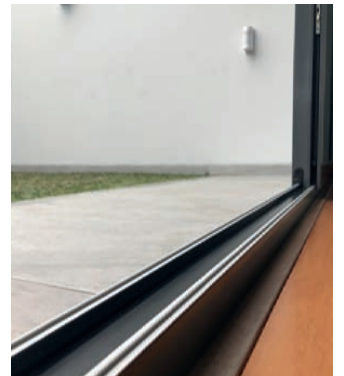
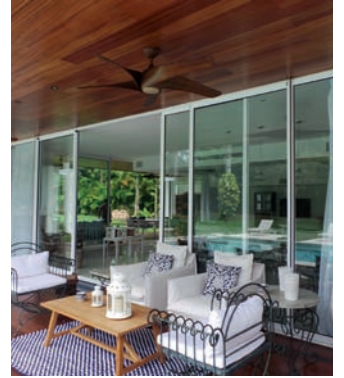
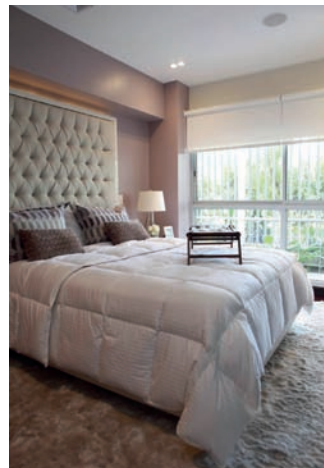
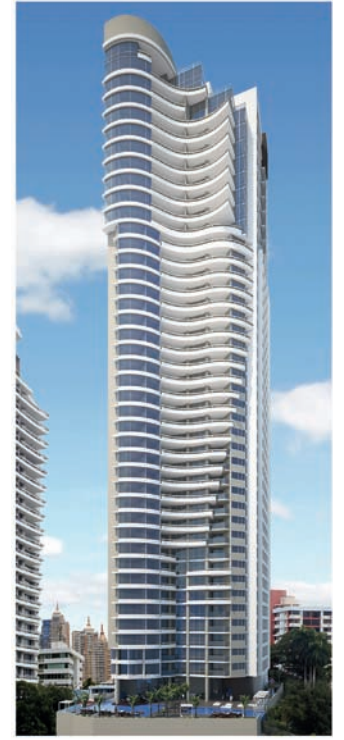
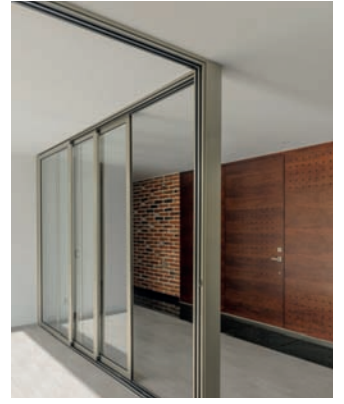
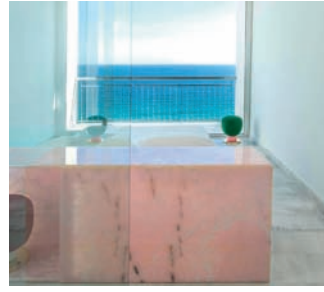
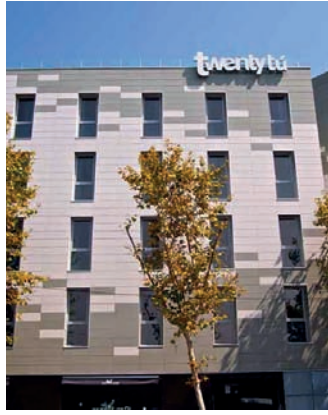

THERMIA®

B A R C E L O N A

Ventanas para vivir mejor

Sede Central en Barcelona

C/ Narcís Monturiol, 34
08192 Sant Quirze del Vallès
Barcelona (España)
Tel. +34 937 121 237
contacto@thermiabarcelona.com
Síguenos en   

Delegación Área Andina

Los Telares, 289
Urbanización Industrial Vulcano
Ate, Lima (Perú)
Tel. +51-1-7197649

Showrooms

Barcelona

Narcís Monturiol, 34
08192 Sant Quirze Valles
Tel. +34 937 121 237

Lima

Paseo de la República, 3583
2o. Piso - San Isidro
Tel. +51-1-7197649

Girona

Carrer Sant Jordi, 2
Local 4 - Sarrià de Ter
Tel. +34 937 121 237

THERMIABARCELONA.COM