

SERIE THERMIA AR78+ C16

Máximo aislamiento térmico.

THE Diseño.
Confort.
Silencio.

THERMIA[®]
B A R C E L O N A

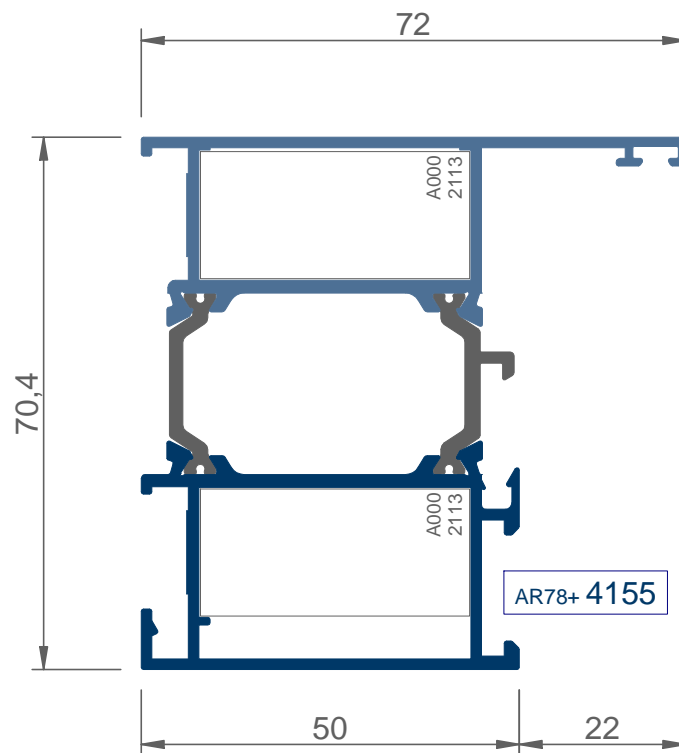
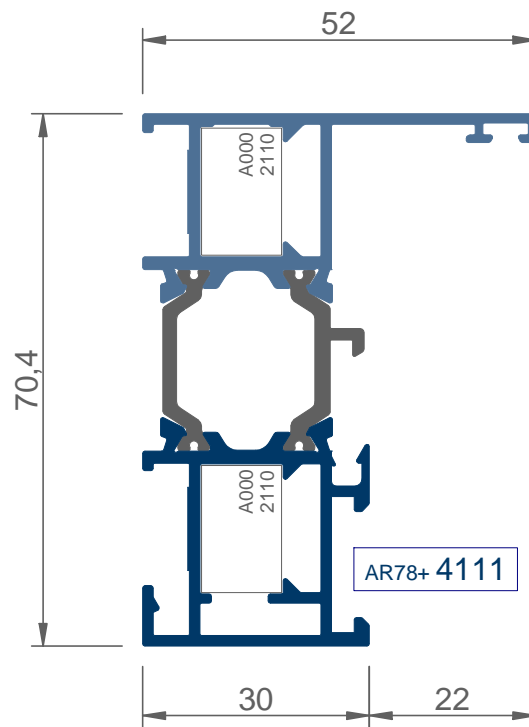

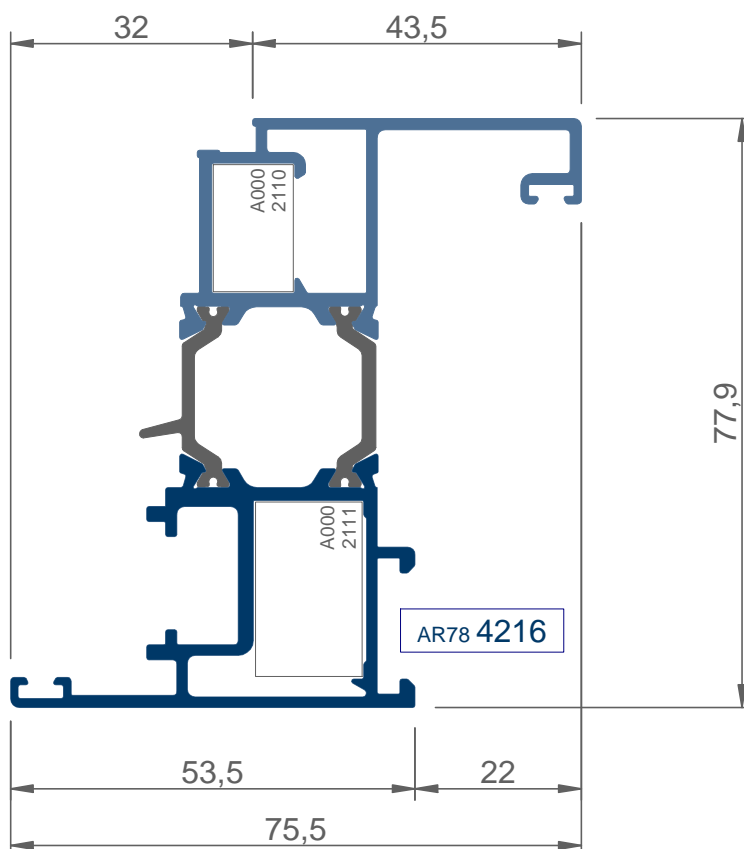
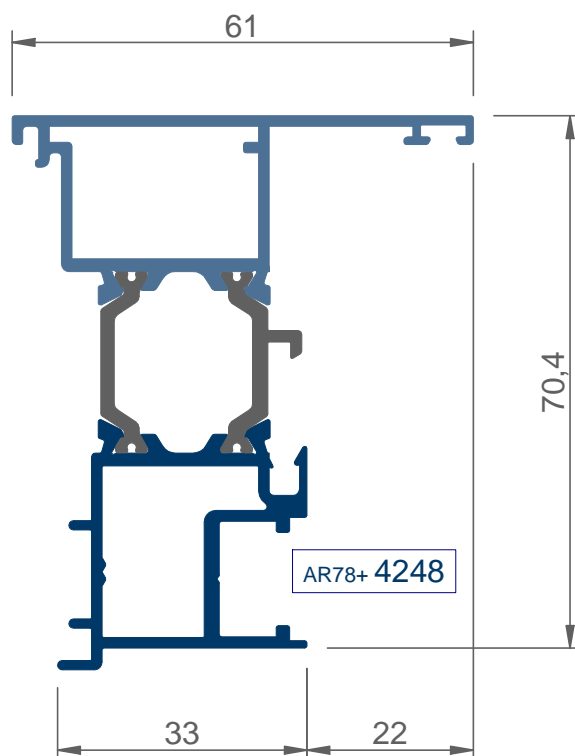

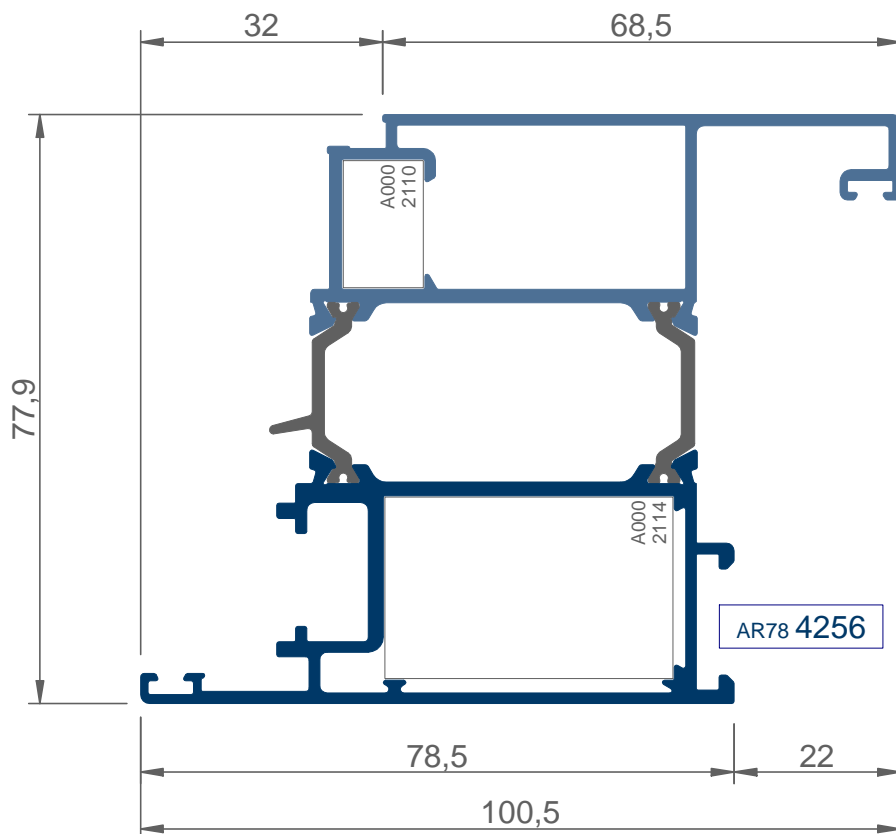
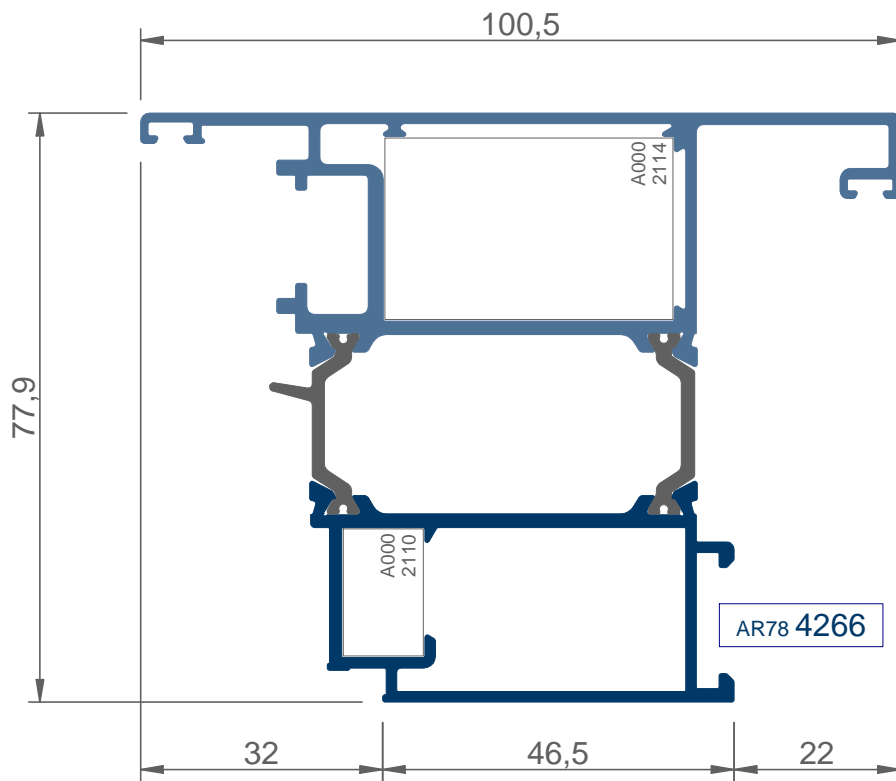

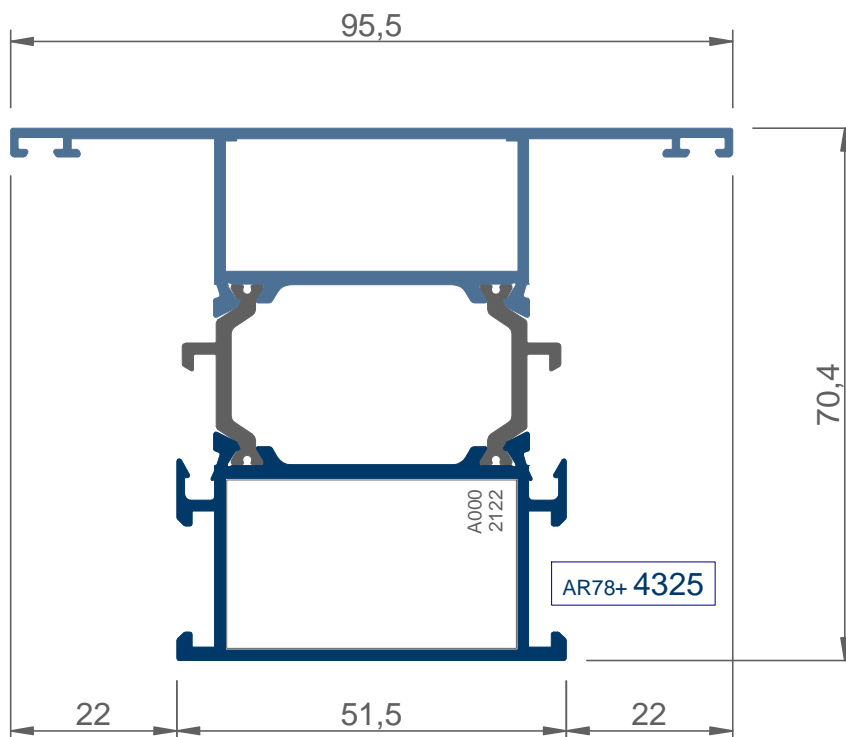
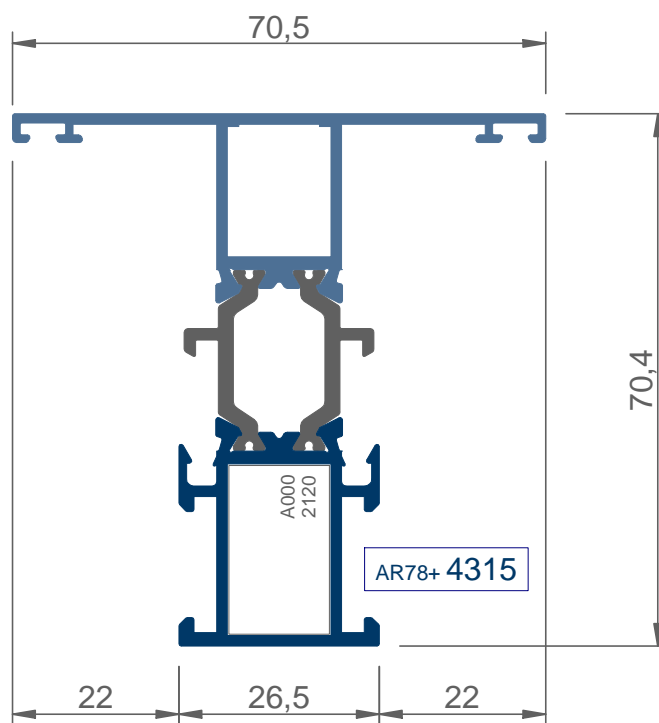

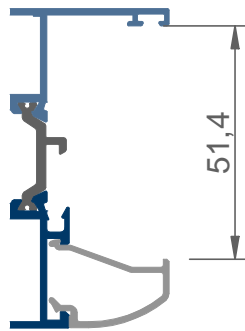

A000 4512

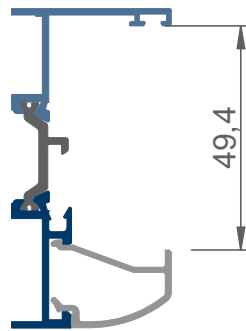

A000 4519

grapa junquillos elípticos

A000 2102

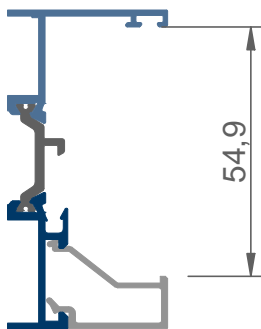
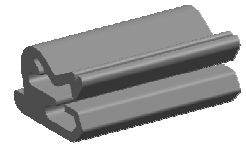

A000 4511

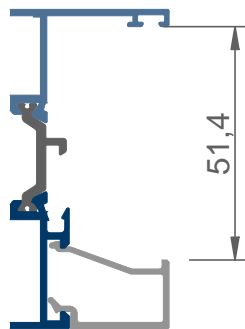

A000 4515

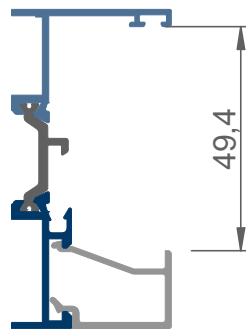

A000 4517

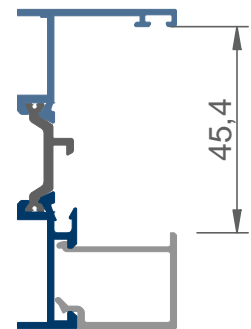

A000 4521

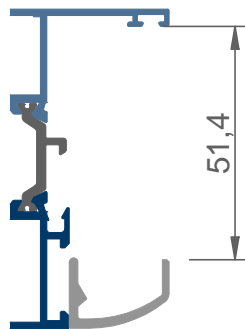

A000 4516

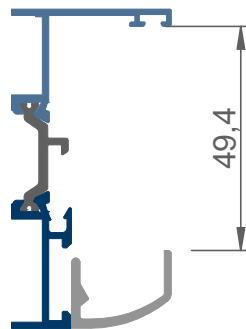

A000 4518

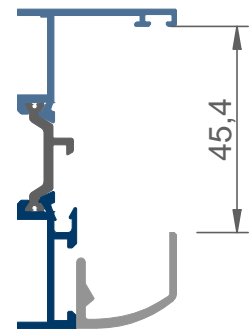

A000 4522

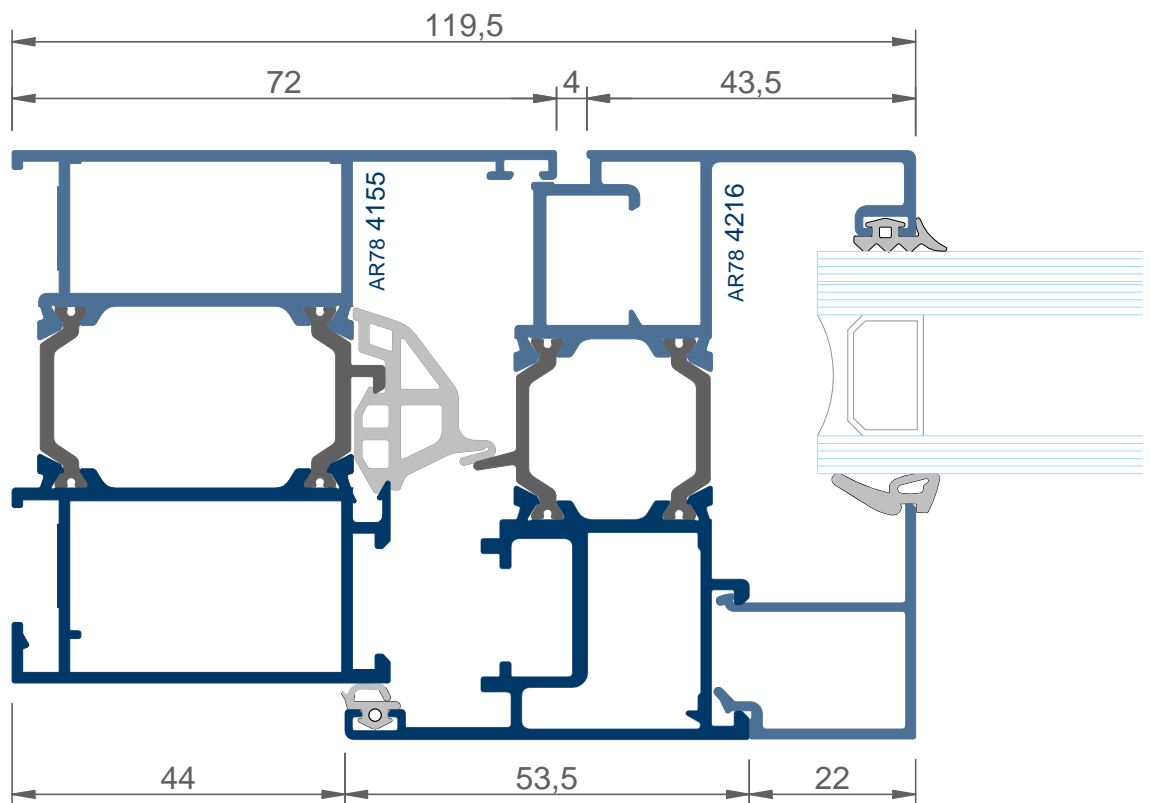
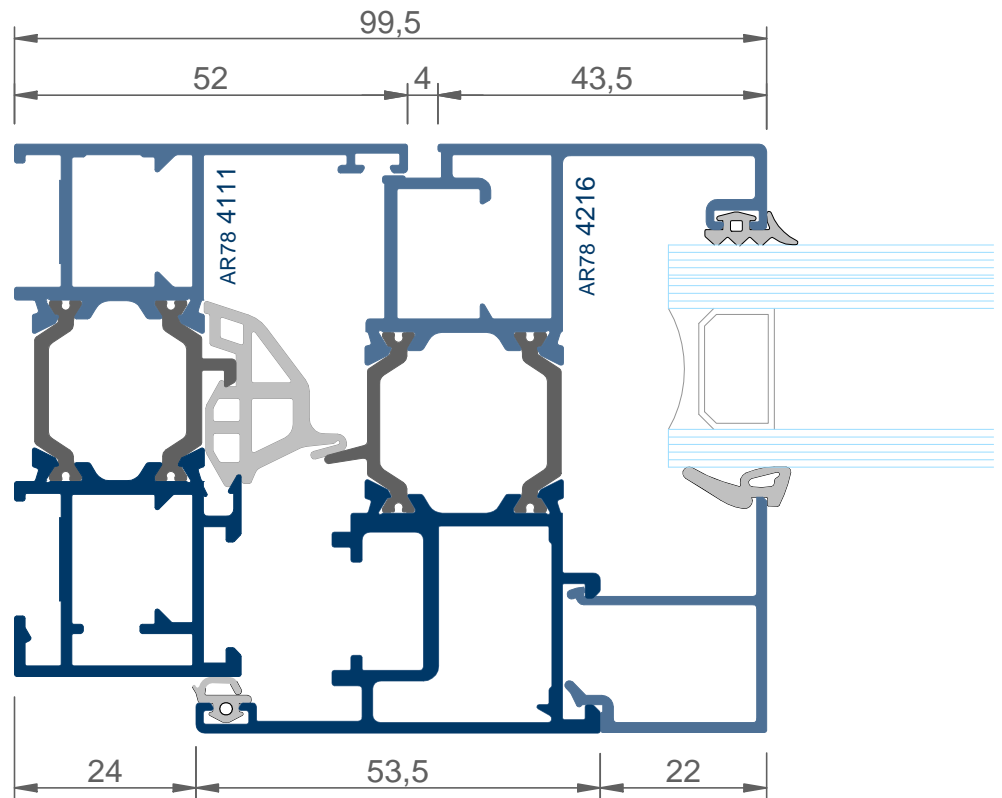

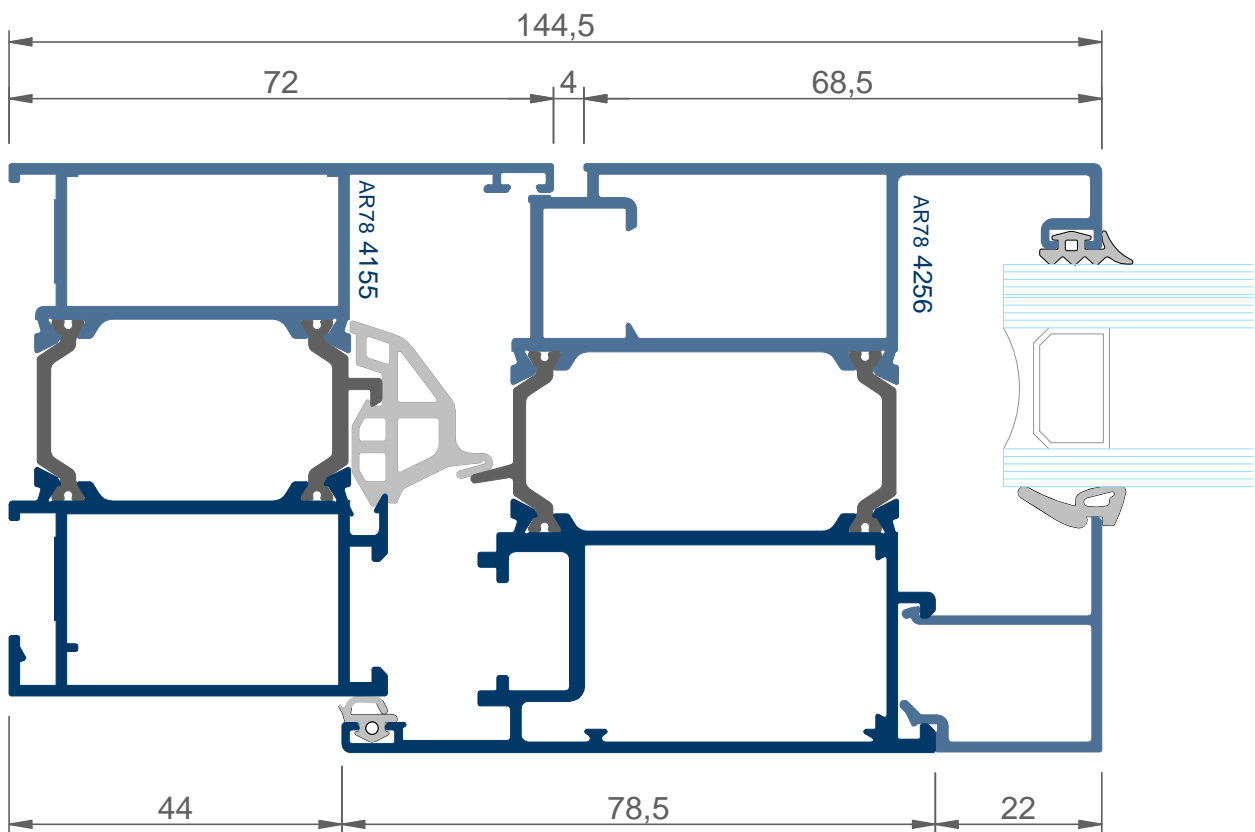
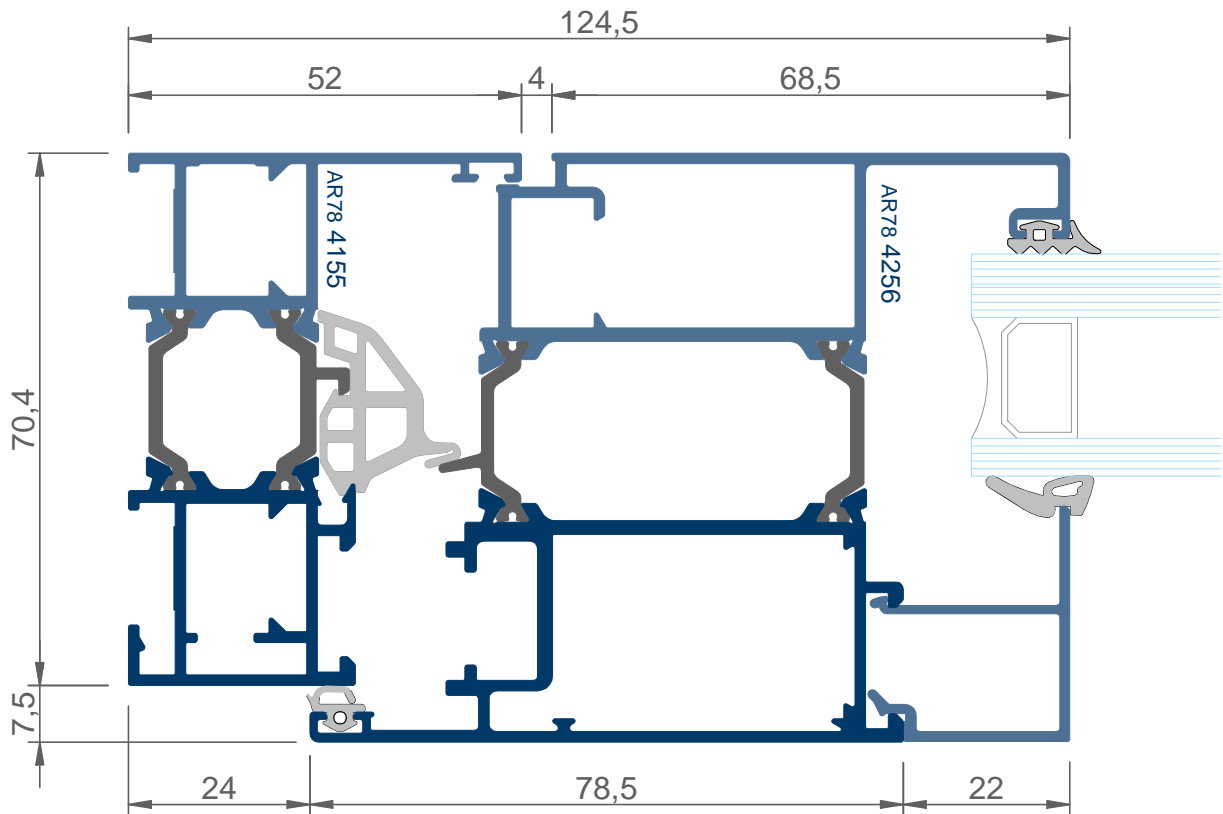

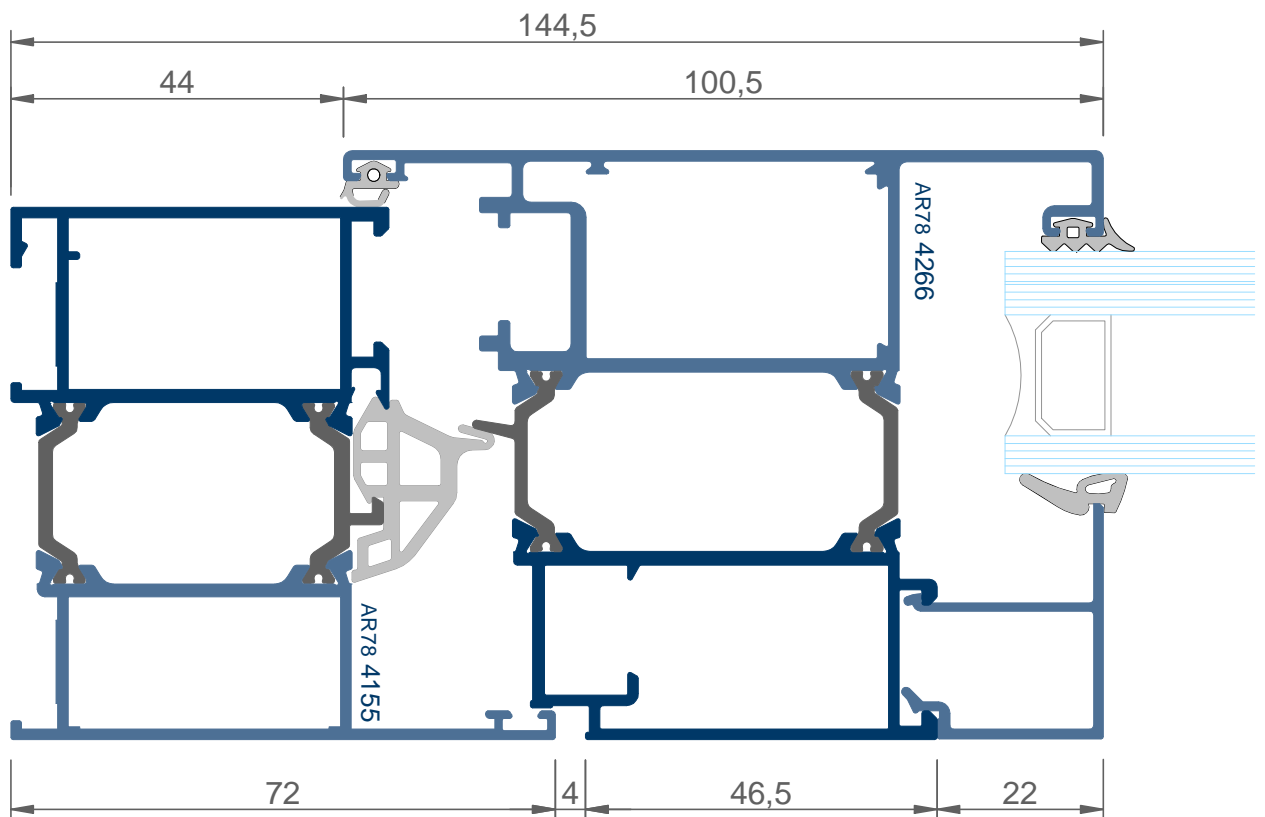
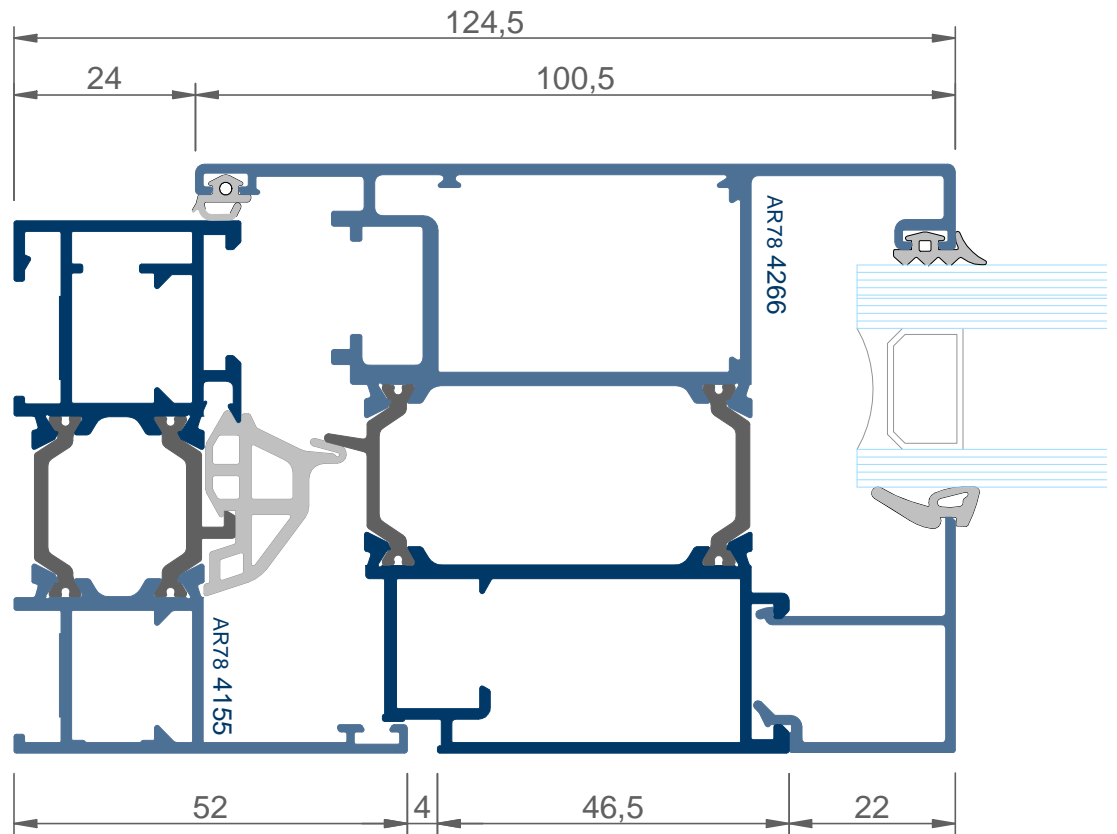

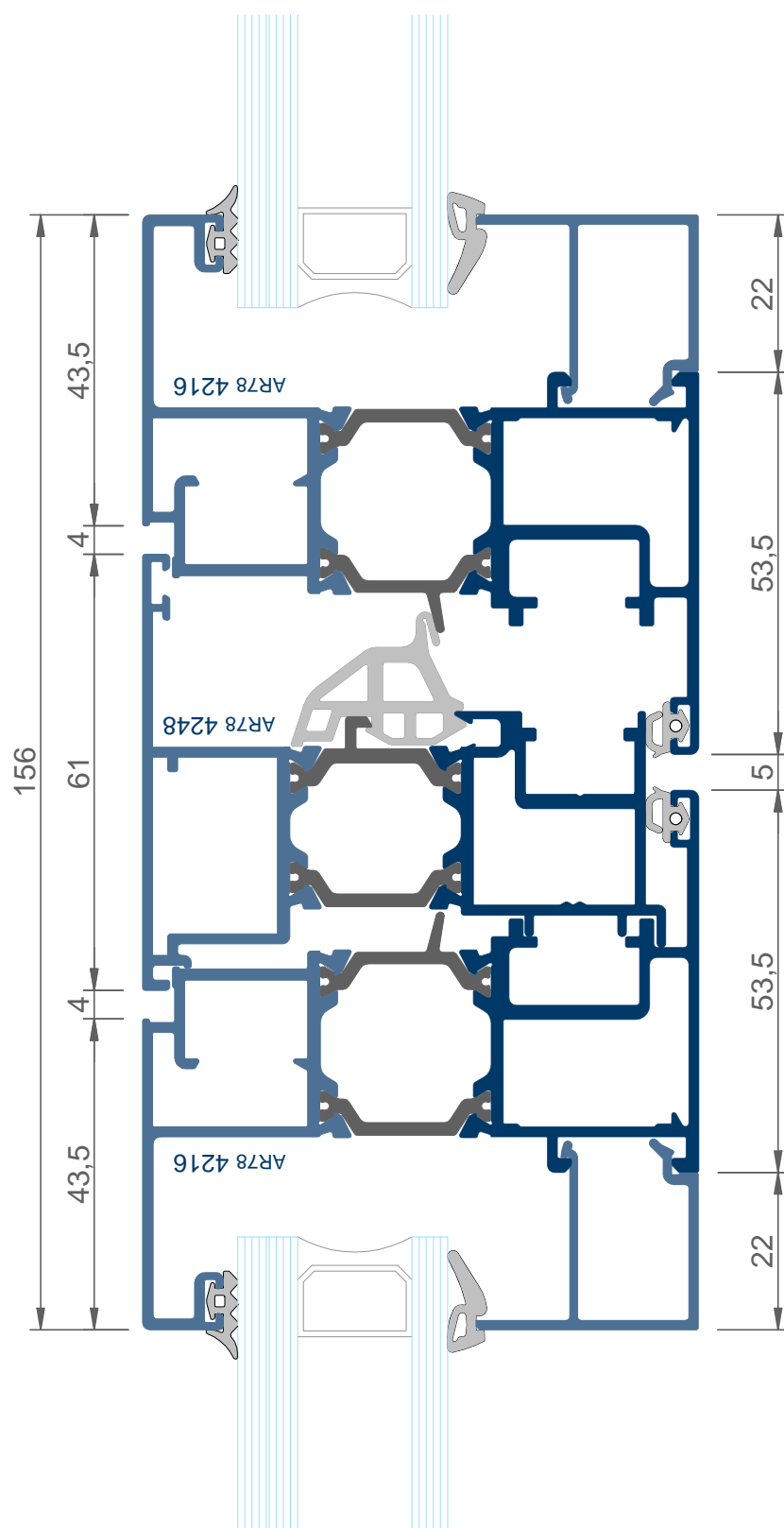

GIRAR PÁGINA PARA UNA CORRECTA LECTURA

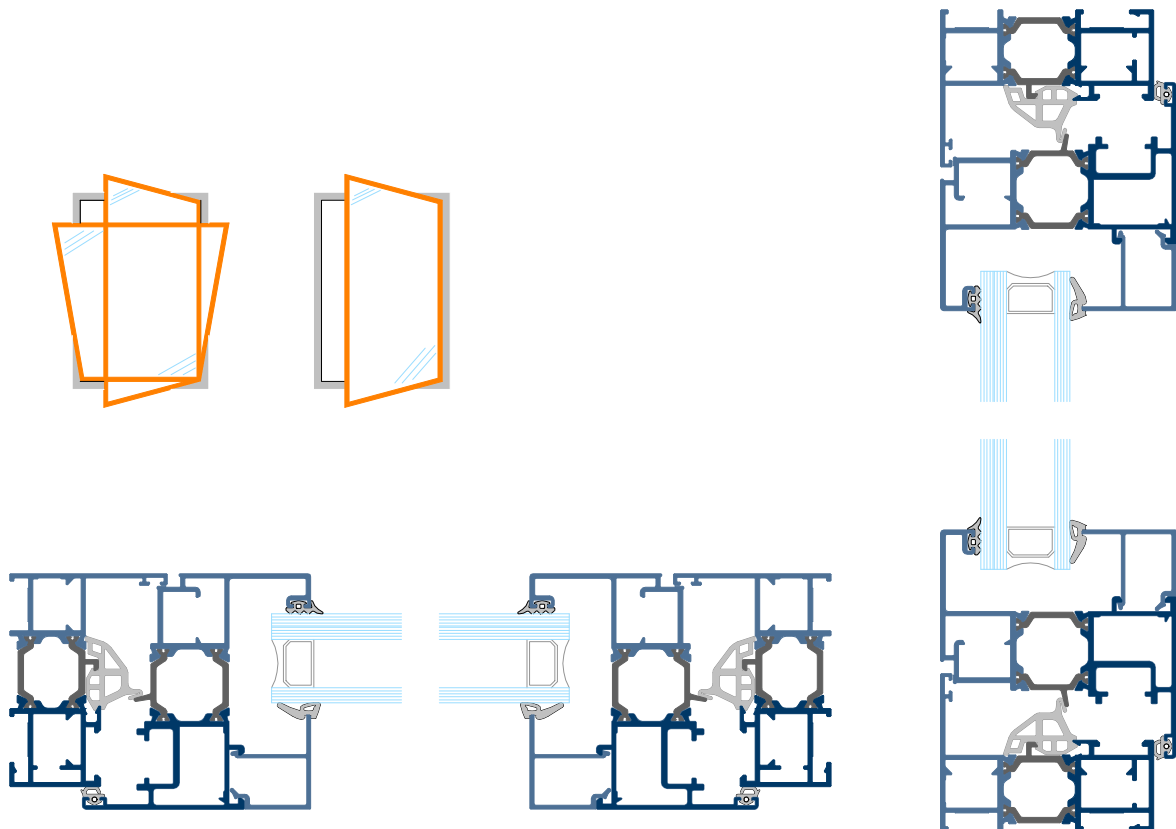

COD	DESCRIPCIÓN	CANT	FORMULA
AR78 4111	marco medio horizontal	2	B
AR78 4111	marco medio vertical	2	H
AR78 4216	hoja horizontal	2	B-49
AR78 4216	hoja vertical	2	H-49
A000 45XX	junquillo horizontal	2	B-155
A000 45XX	junquillo vertical	2	H-199
vidrio		1	B-174 x H-174
A000 2110	escuadras	12	
A000 2111	escuadra int hoja C16	4	
A000 2301	tapa desagüe	2	
A000 2308	junta central +	2	B+H
A000 2320	junta cierre hoja	2	B+H
A000 2351	junta ext vidrio	2	B+H
A000 235x	junta int vidrio	2	B+H

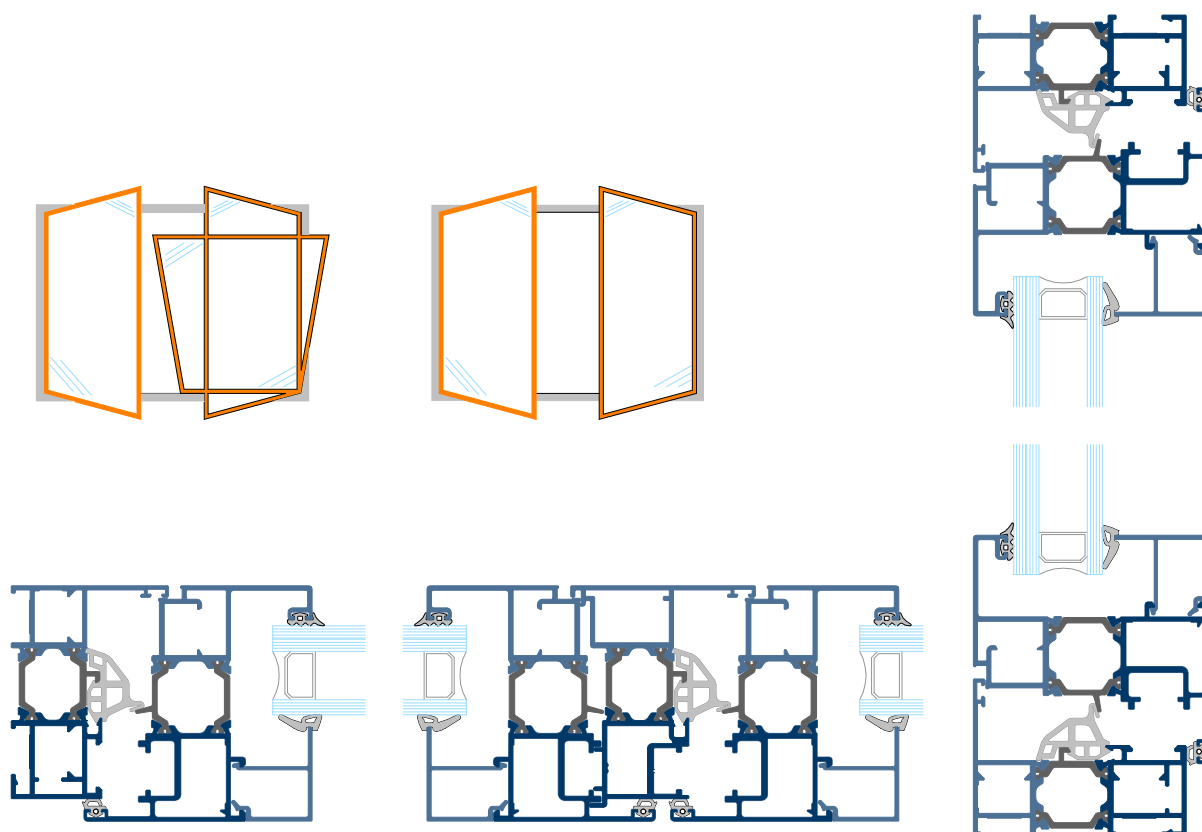

COD	DESCRIPCIÓN	CANT	FORMULA
AR78 4111	marco medio horizontal	2	B
AR78 4111	marco medio vertical	2	H
AR78 4216	hoja horizontal	4	$(B-54)/2$
AR78 4216	hoja vertical	4	H-49
AR78 4248	inversor C16	1	H-117
A000 45XX	junquillo horizontal	4	$(B-267)/2$
A000 45XX	junquillo vertical	4	H-199
vidrio		2	$(B-305)/2 \times H-174$
A000 2110	escuadras	16	
A000 2111	escuadra int hoja C16	8	
A000 2343	juego tapas inv C16	1	
A000 2342	complem juego tapas	1	
A000 2301	tapa desagüe	3	
A000 2308	junta central +	1	$2B + 3H$
A000 2320	junta cierre hoja	1	$2B + 4H$
A000 2351	junta ext vidrio	1	$2B + 4H$
A000 235x	junta int vidrio	1	$2B + 4H$

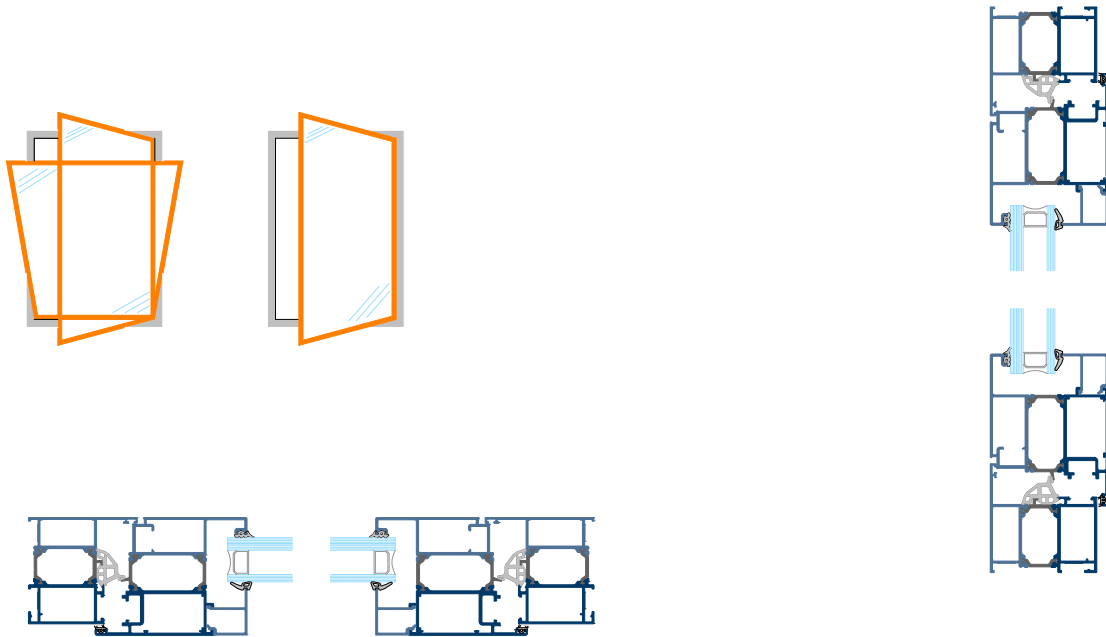

COD	DESCRIPCIÓN	CANT	FORMULA
AR78 4155	marco ancho horizontal	2	B
AR78 4155	marco ancho vertical	2	H
AR78 4256	hoja balconera horizontal	2	B-89
AR78 4256	hoja balconera vertical	2	H-89
A000 45XX	junquillo horizontal	2	B-245
A000 45XX	junquillo vertical	2	H-289
vidrio		1	B-264 x H-264
A000 2110	escuadra ex hoja	4	
A000 2113	escuadra int hoja	4	
A000 2114	escuadras marco	8	
A000 2301	tapa desagüe	2	
A000 2308	junta central +	2	B+H
A000 2320	junta cierre hoja	2	B+H
A000 2351	junta ext vidrio	2	B+H
A000 235x	junta int vidrio	2	B+H

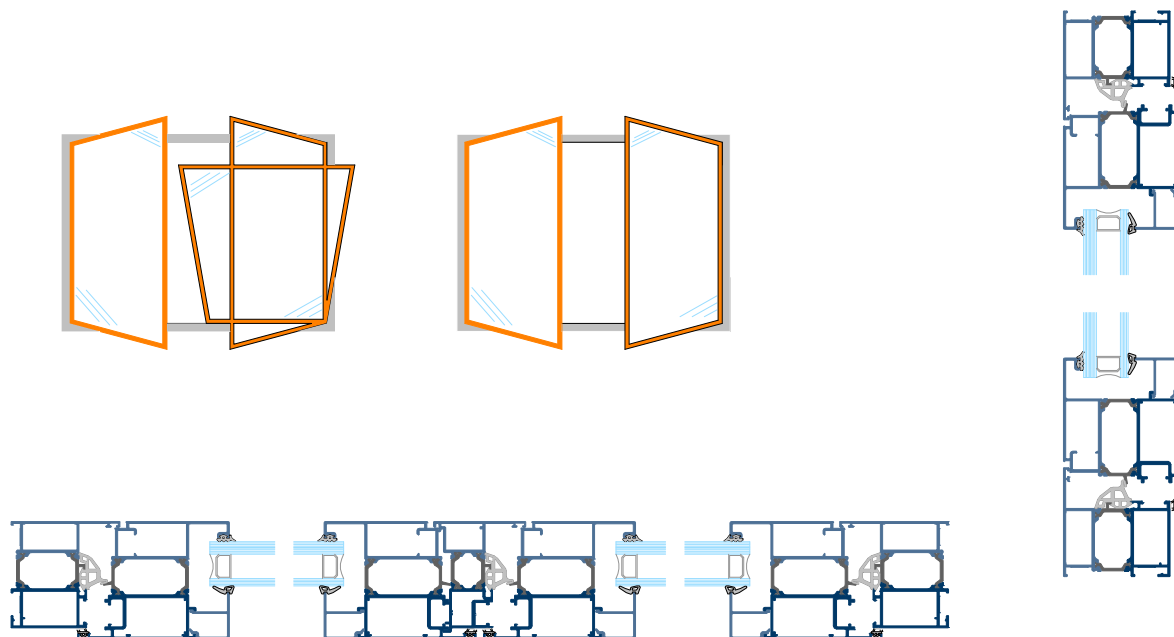

COD	DESCRIPCIÓN	CANT	FORMULA
AR78 4155	marco ancho horizontal	2	B
AR78 4155	marco ancho vertical	2	H
AR78 4256	hoja balconera horizontal	4	$(B-94) / 2$
AR78 4256	hoja balconera vertical	4	H-89
AR78 4248	inversor C16	1	H-157
A000 45XX	junquillo horizontal	4	$(B-407) / 2$
A000 45XX	junquillo vertical	4	H-289
vidrio		2	$(B-445)/2 \times H-264$
A000 2110	escuadra ex hoja	8	
A000 2113	escuadra int hoja	8	
A000 2114	escuadras marco	8	
A000 2301	tapa desagüe	3	
A000 2343	juego tapas inv C16	1	
A000 2342	juego tapas complem inv	1	
A000 2308	junta central +	1	2B + 3H
A000 2320	junta cierre hoja	1	2B + 4H
A000 2351	junta ext vidrio	1	2B + 4H
A000 235x	junta int vidrio	1	2B + 4H