



# SERIE MALLORQUINA

Solución perfecta para protección en fachada.

**THE** Diseño.  
Confort.  
Silencio.

**THERMIA**<sup>®</sup>  
B A R C E L O N A



perfiles

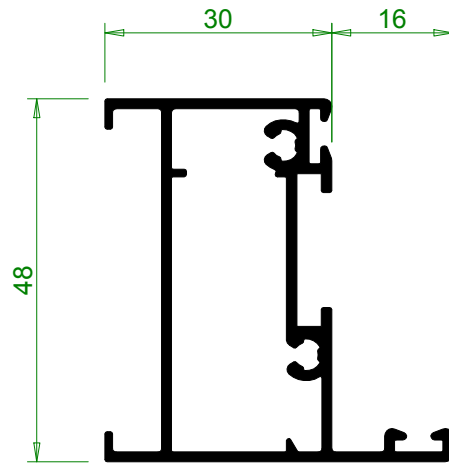

PM40 4110  
marco normal

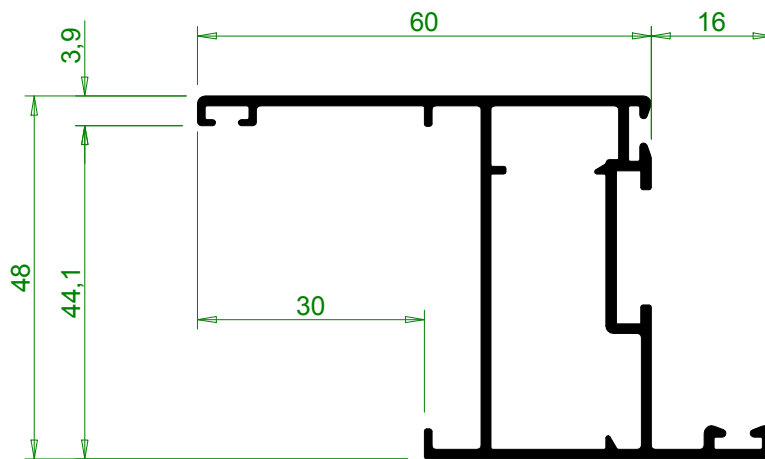

PM40 4112  
marco con solape

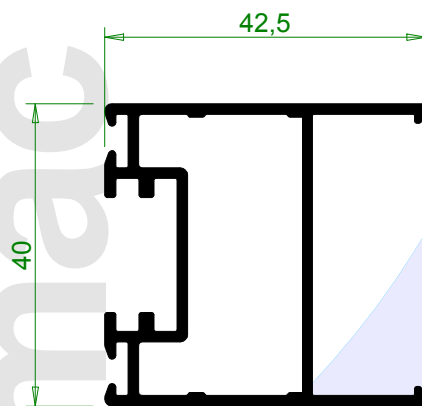

PM40 4210  
hoja pequeña

03

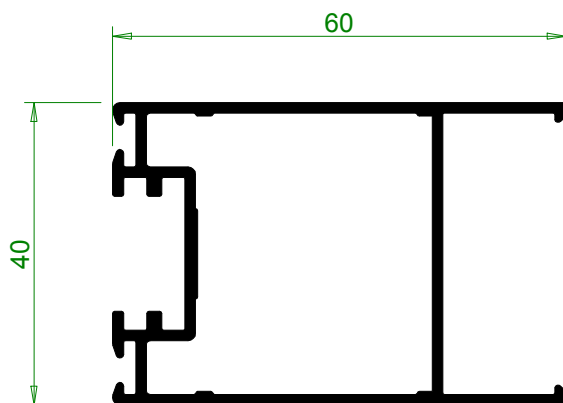

PM40 4220  
hoja normal

04

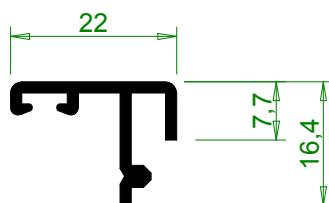

PM40 4240  
batiente hoja

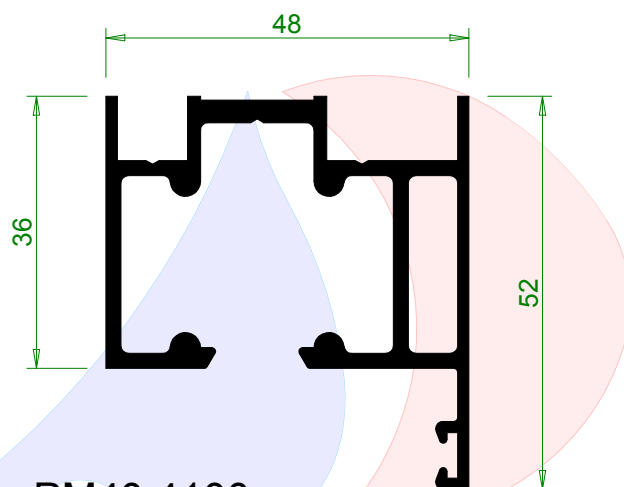

PM40 4100  
carril superior plegable

dimac

AD Sistemas

mallorquina

perfiles

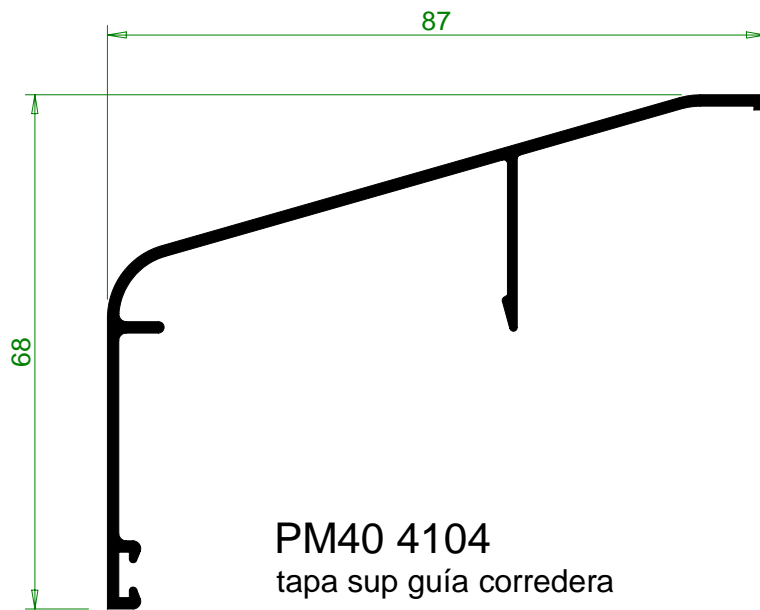

PM40 4104  
tapa sup guía corredera

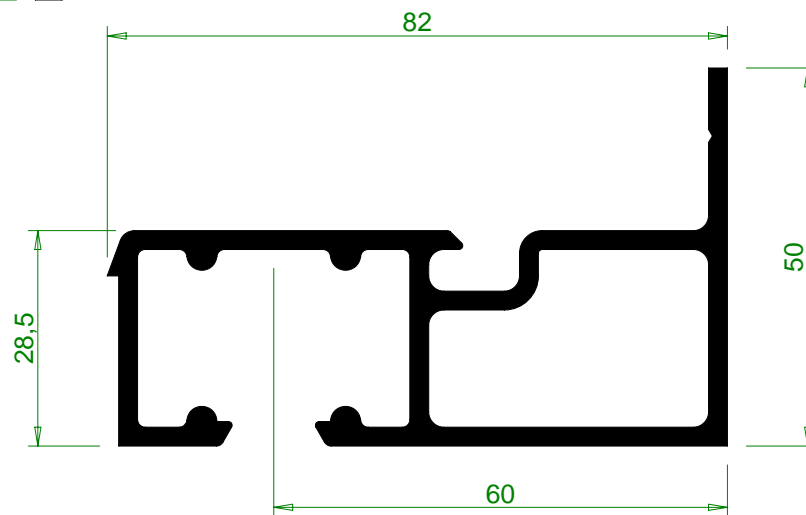

PM40 4101  
guía sup corredera

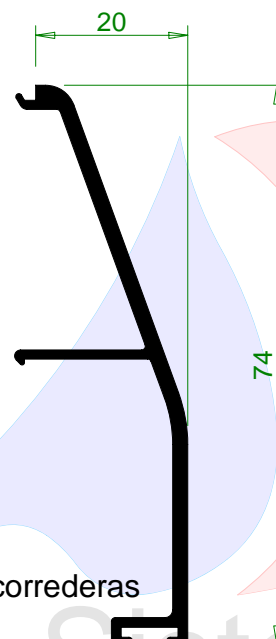

PM40 4105  
tapa lateral hojas correderas

05

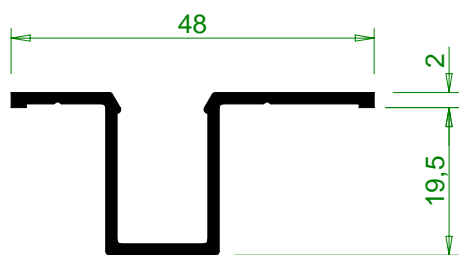

PM40 4102  
guía inferior empotrada

06

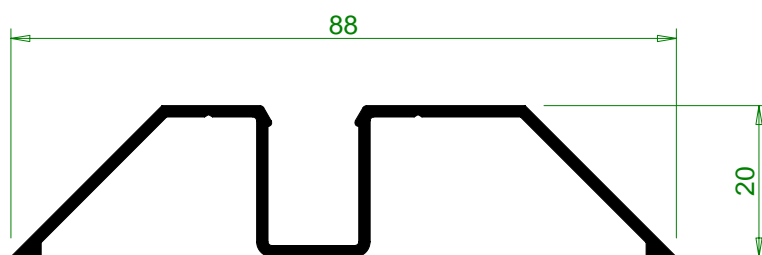

PM40 4103  
guía inferior sobrepuesta

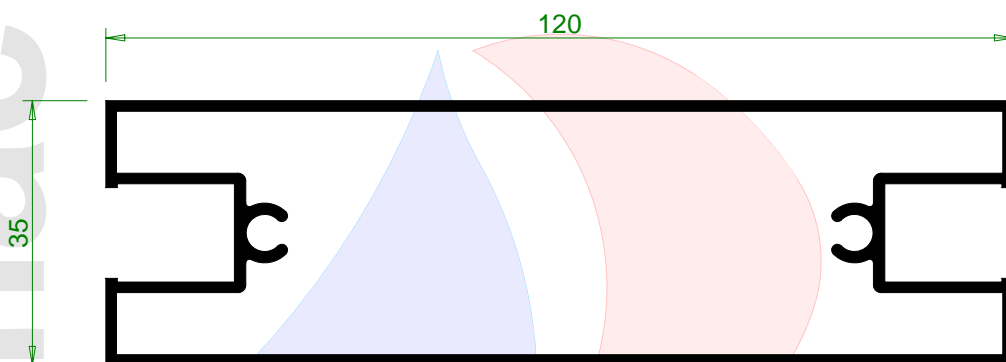

PM40 4356  
travesaño

dimac

AD Sistemas

mallorquina

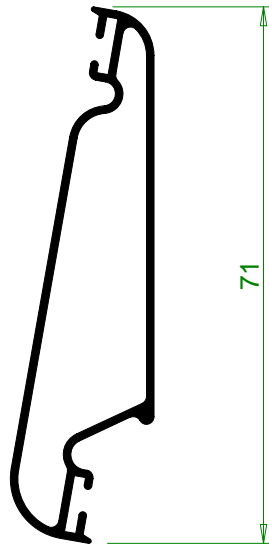

PM40 0020  
lama móvil

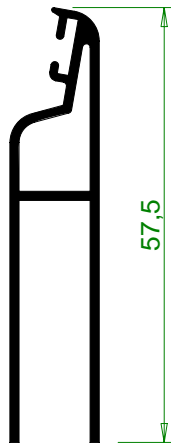

PM40 0030  
media lama compensación

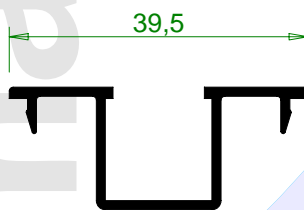

PM40 4560  
reductor alojamiento lama

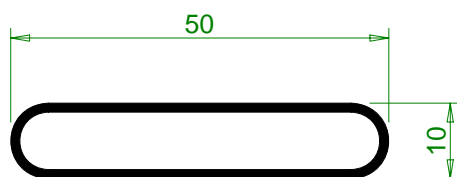

PM40 0010  
lama fija

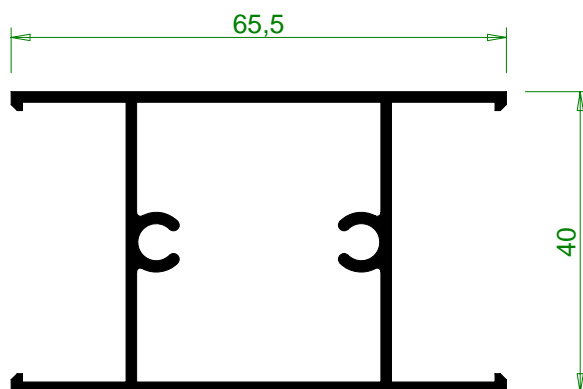

PM40 4358  
divisor de lamas

08

A0004735  
solape elíptico

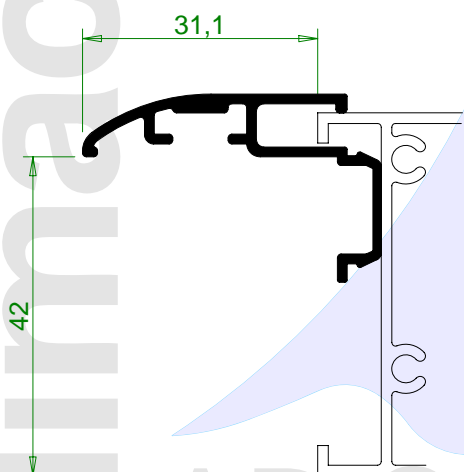

A0004736  
solape recto

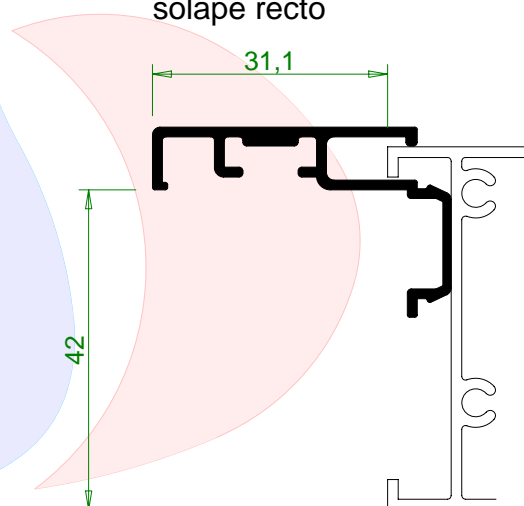

hilmac  
AD Sistemas

mallorquina



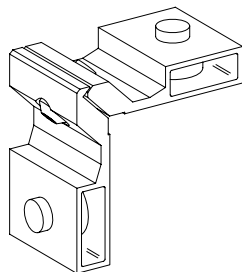

**PM40 2112**  
escuadra pequeña

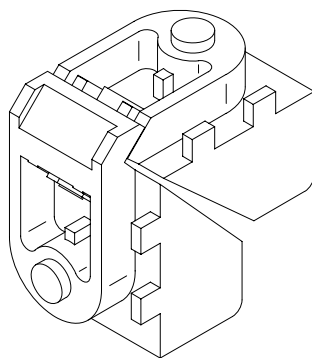

**PM40 2110**  
escuadra grande

09

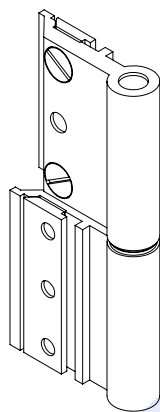

**PM40 3110**  
bisagra normal

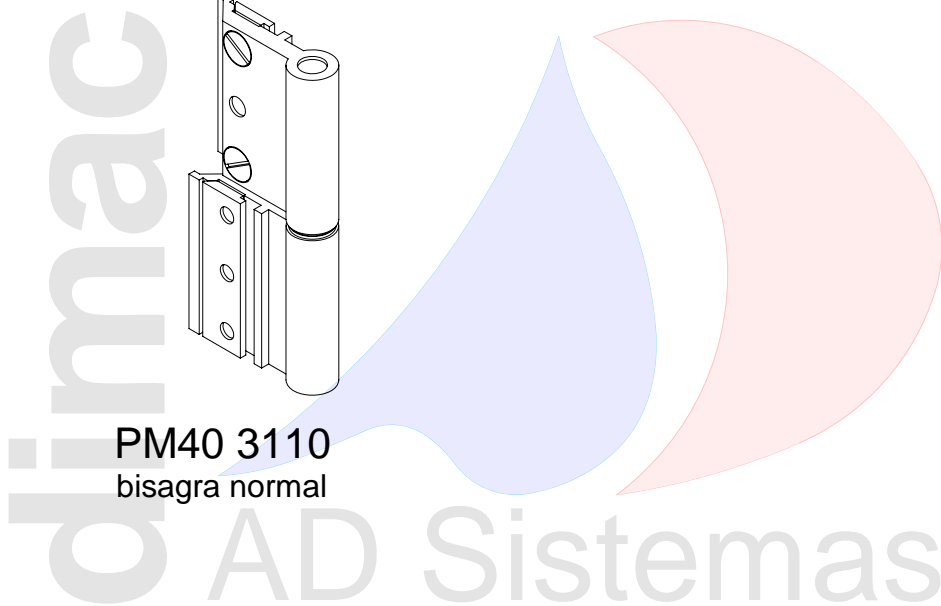

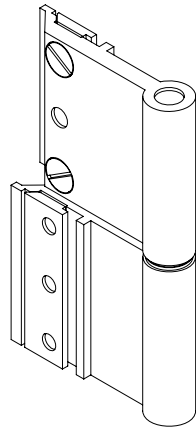

**PM40 3140**  
bisgra pala larga

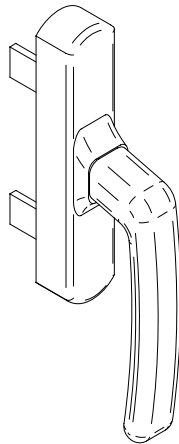

**PM40 3100**  
cremona

10



**PM40 3101**  
terminal pletina

dimac

AD Sistemas

mallorquina

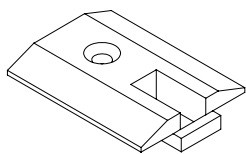

**PM40 3102**  
cerradero abatible

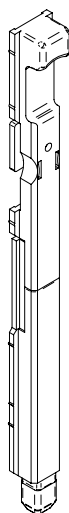

11

**1541**  
pasador hoja pasiva

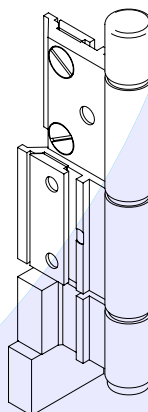
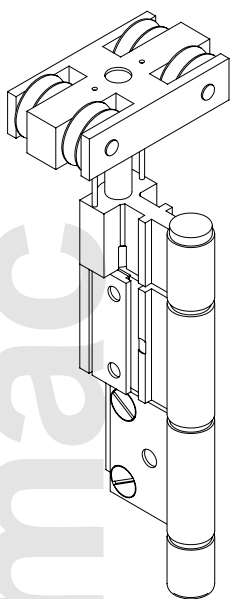

**PM40 3310**  
conjunto bisagras plegable

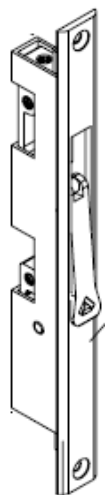

**PM40 3103**  
cierre empotrado



**PM40 3106**  
pomo tirador 3103



**PM40 3105**  
tornillos conexión 3103+plet

12

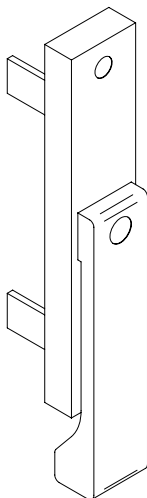

**PM40 3104**  
cremona plana

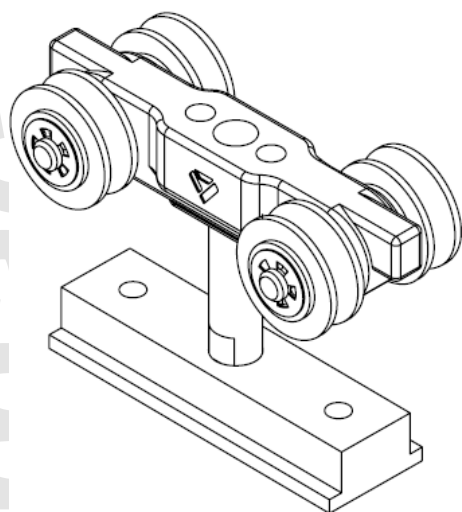

**PM40 3810**  
rueda hojas correderas

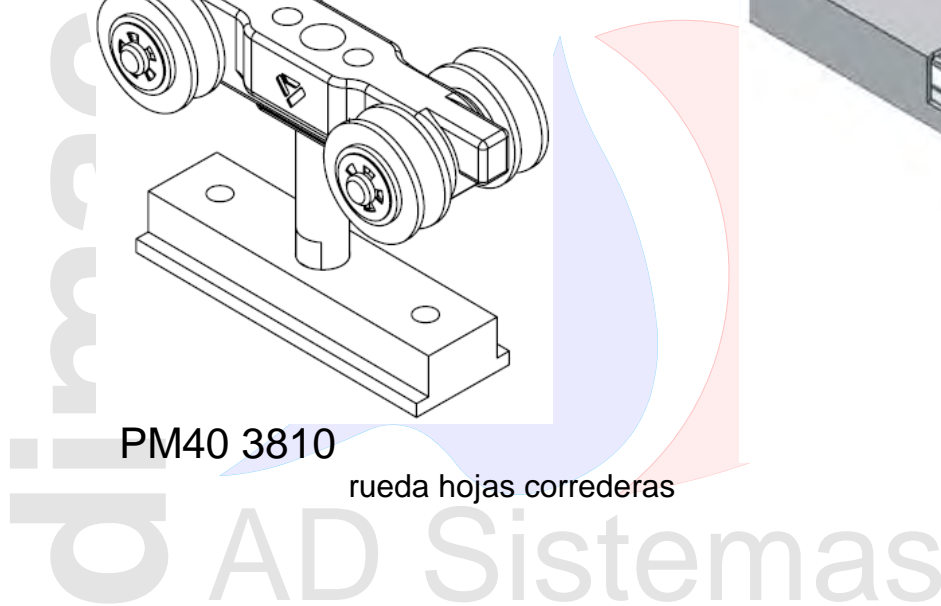
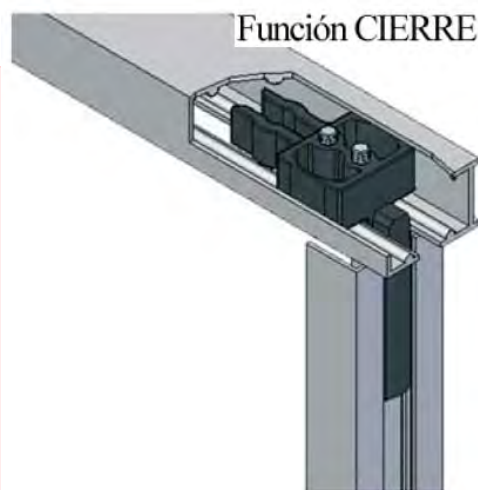

## accesorios

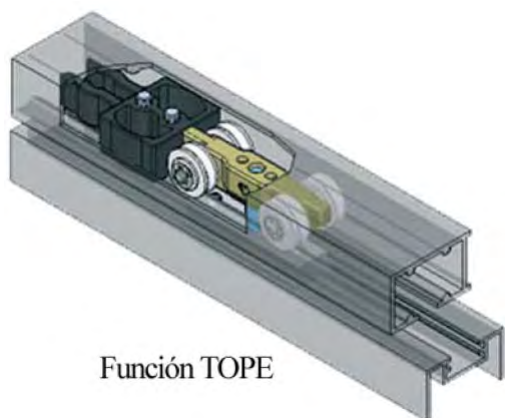

Función TOPE

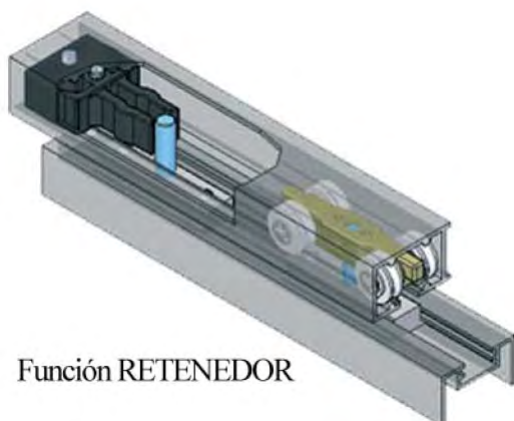

Función RETENEDOR

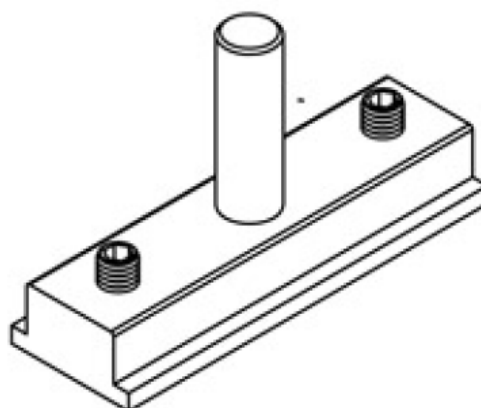

PM40 3840  
pieza/eje fijación hojas correderas

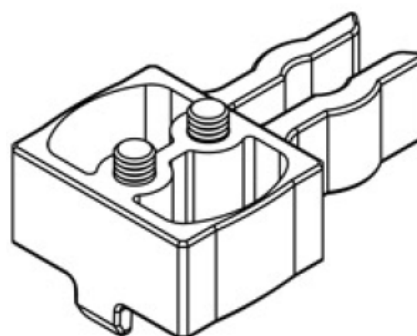

PM40 3830  
tope final carrera / base fijación

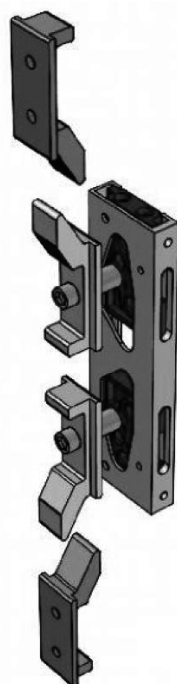

PM40 3860  
mec interior, ganchos  
y cerraderos corredera

mallorquina

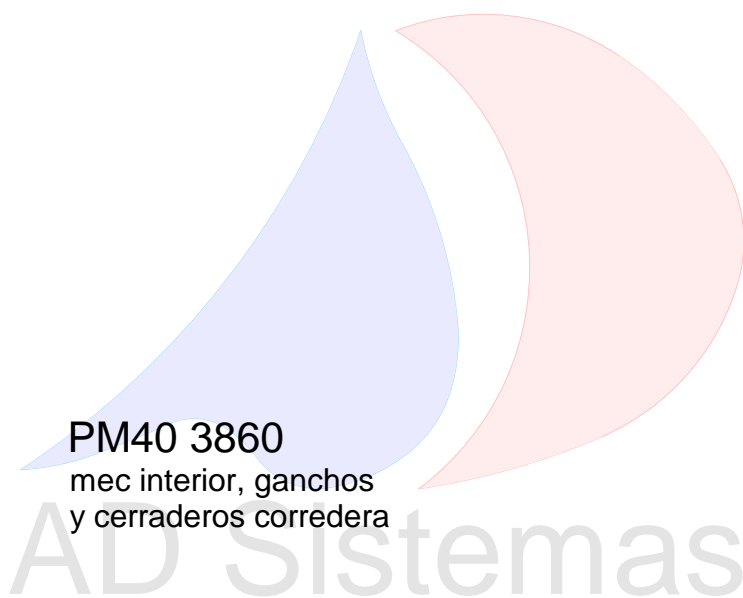

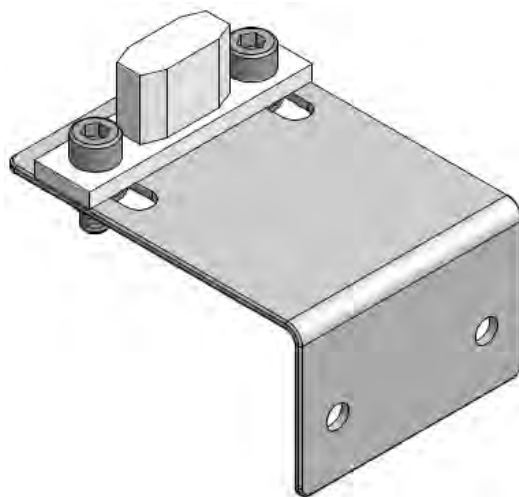

**PM40 3822**  
pieza guía hojas correderas colgadas

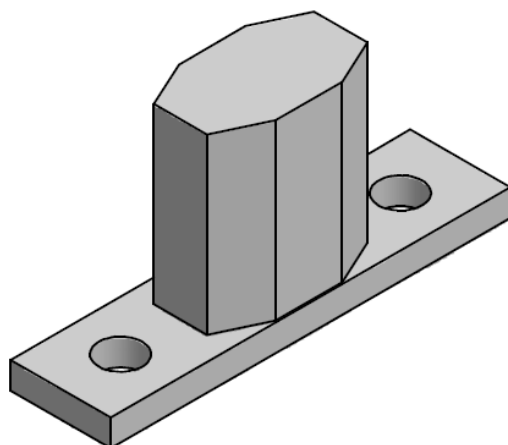

**PM40 3820**  
pieza inferior guía hojas correderas

14



**A000 2320**  
junta hojas



**PM40 2359**  
cepillo cierre hojas correderas



**PM40 2310**  
junta lamas móviles

dimac

AD Sistemas

mallorquina

## accesorios

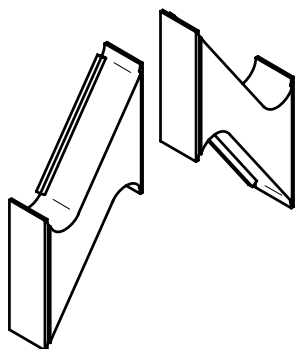

**PM40 2850**  
piezas separadoras lamas fijas

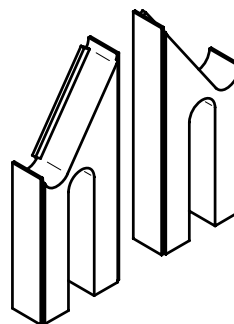

**PM40 2851**  
piezas terminales lamas fijas

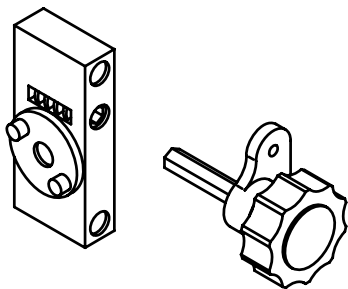

**PM40 2803**  
pomo rotación  
lamas móviles

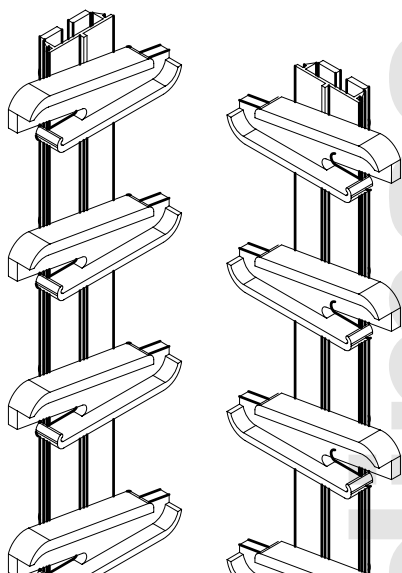

**mallorquina**

<b>REFERENCIA</b>	<b>Descripción</b>	<b>de</b>	<b>α</b>
PM40 2806	mecanismo 6 lamas móviles	401	460
PM40 2807	mecanismo 7 lamas móviles	461	520
PM40 2808	mecanismo 8 lamas móviles	521	580
PM40 2809	mecanismo 9 lamas móviles	581	640
PM40 2810	mecanismo 10 lamas móviles	641	700
PM40 2811	mecanismo 11 lamas móviles	701	760
PM40 2812	mecanismo 12 lamas móviles	761	820
PM40 2813	mecanismo 13 lamas móviles	821	880
PM40 2814	mecanismo 14 lamas móviles	881	940
PM40 2815	mecanismo 15 lamas móviles	941	1.000
PM40 2816	mecanismo 16 lamas móviles	1.001	1.060
PM40 2817	mecanismo 17 lamas móviles	1.061	1.120
PM40 2818	mecanismo 18 lamas móviles	1.121	1.180
PM40 2819	mecanismo 19 lamas móviles	1.181	1.240
PM40 2820	mecanismo 20 lamas móviles	1.241	1.300
PM40 2821	mecanismo 21 lamas móviles	1.301	1.360
PM40 2822	mecanismo 22 lamas móviles	1.361	1.420
PM40 2823	mecanismo 23 lamas móviles	1.421	1.480
PM40 2824	mecanismo 24 lamas móviles	1.481	1.540
PM40 2825	mecanismo 25 lamas móviles	1.541	1.600
PM40 2826	mecanismo 26 lamas móviles	1.601	1.660
PM40 2827	mecanismo 27 lamas móviles	1.661	1.720
PM40 2828	mecanismo 28 lamas móviles	1.721	1.780
PM40 2829	mecanismo 29 lamas móviles	1.781	1.840
PM40 2830	mecanismo 30 lamas móviles	1.841	1.900
PM40 2831	mecanismo 31 lamas móviles	1.901	1.960
PM40 2832	mecanismo 32 lamas móviles	1.961	2.020
PM40 2833	mecanismo 33 lamas móviles	2.021	2.080
PM40 2852	mecanismo 52 lamas móviles	401	3.220

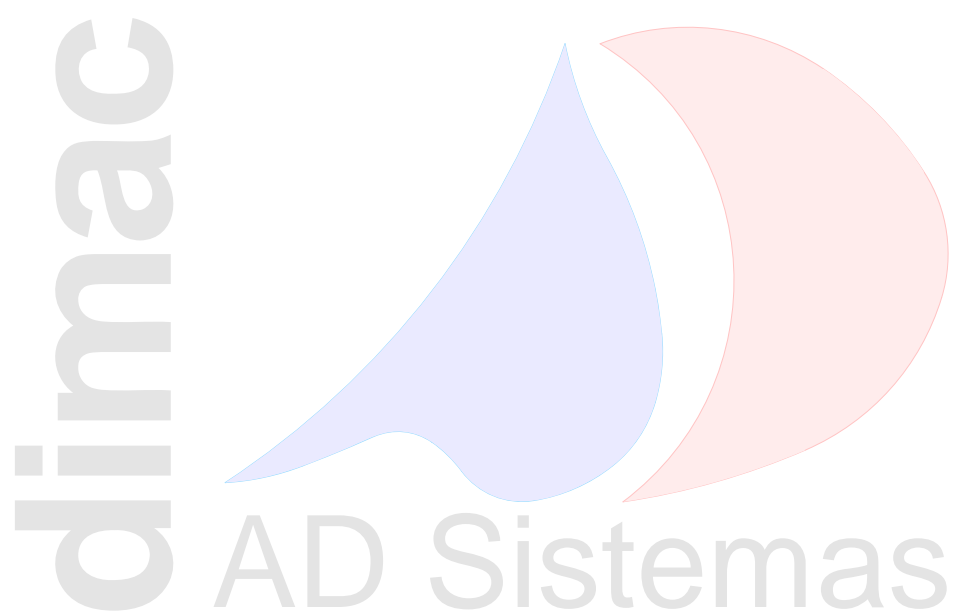

mallorquina



# mallorquinas abatibles

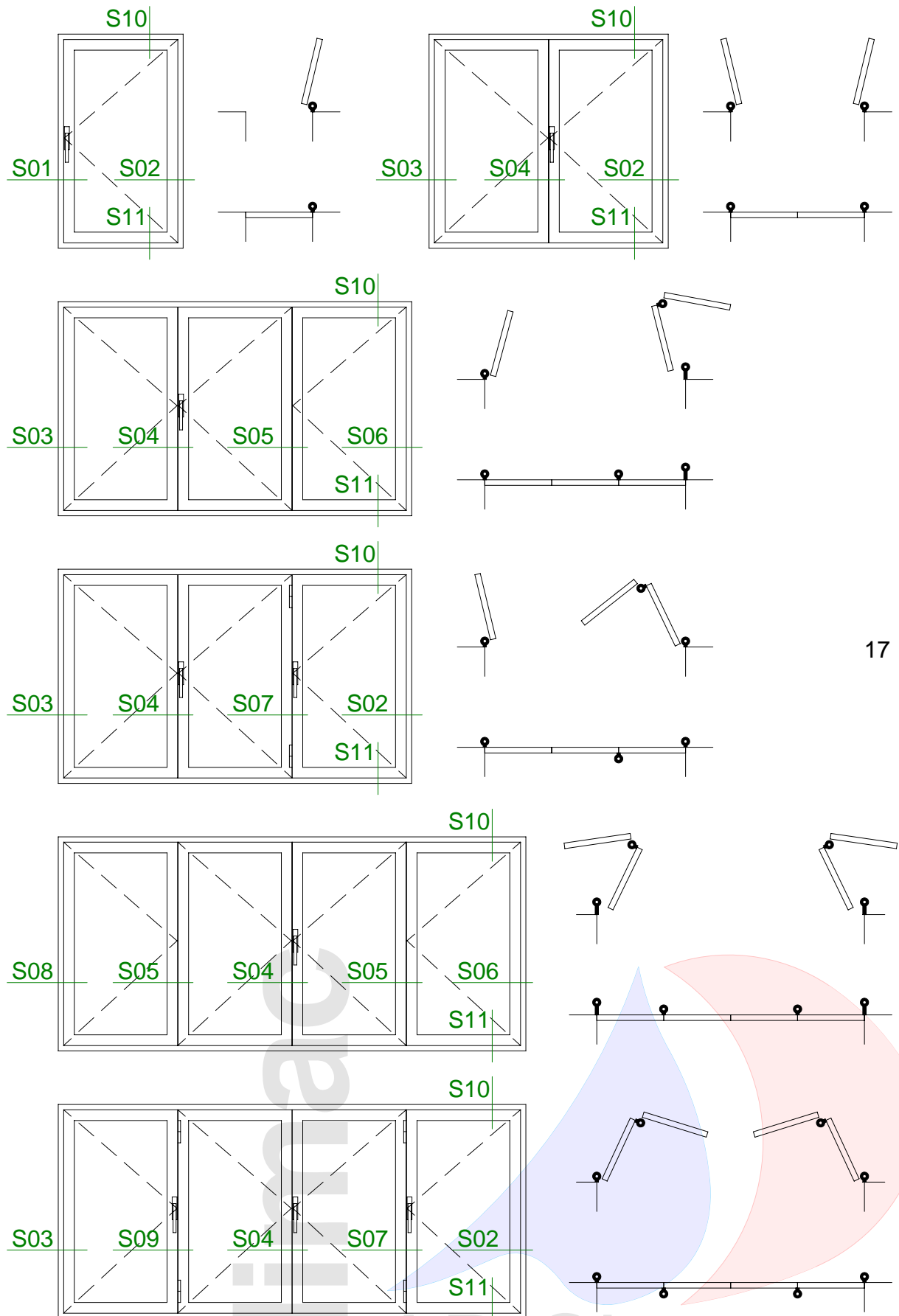

# mallorquina

# mallorquinas plegables

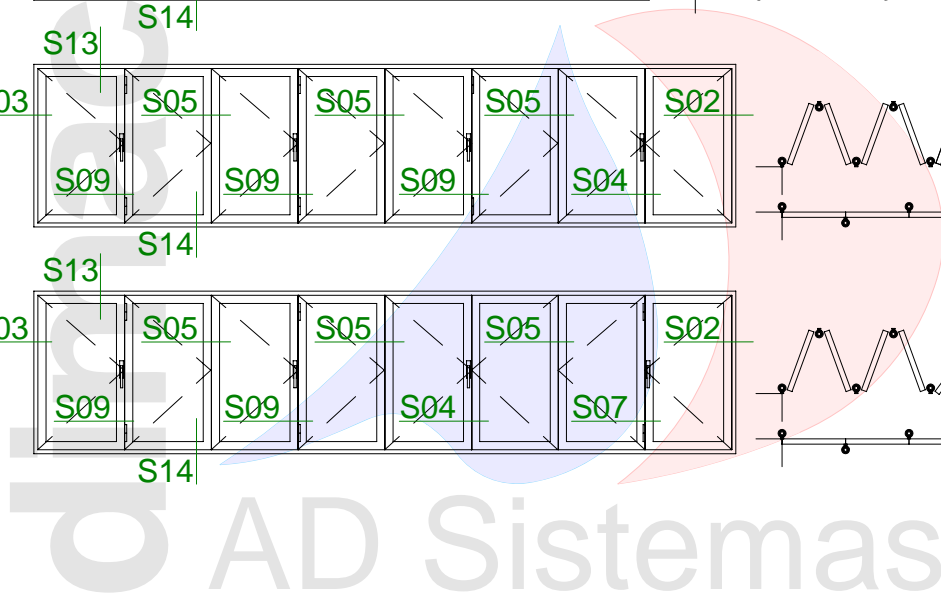
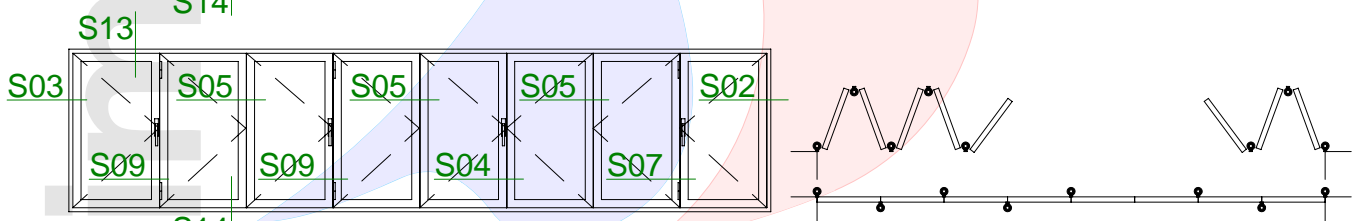
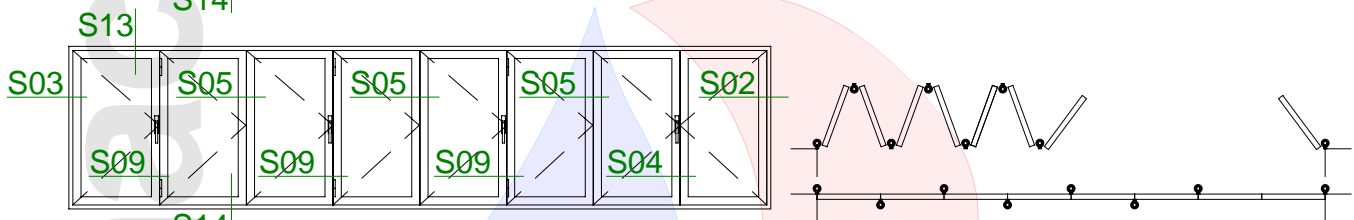
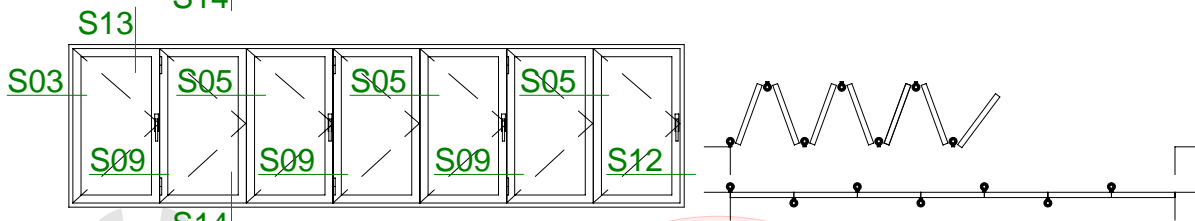
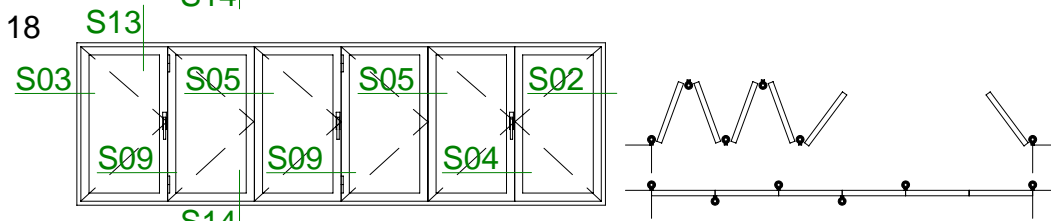
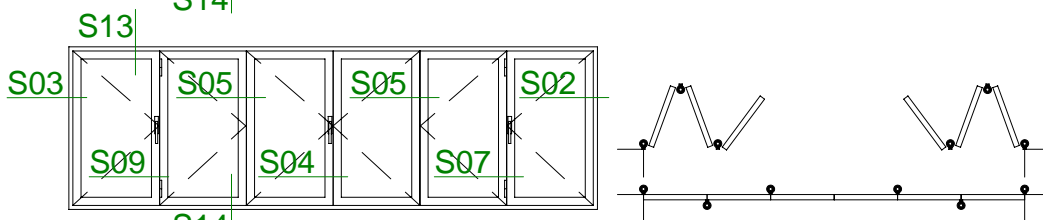
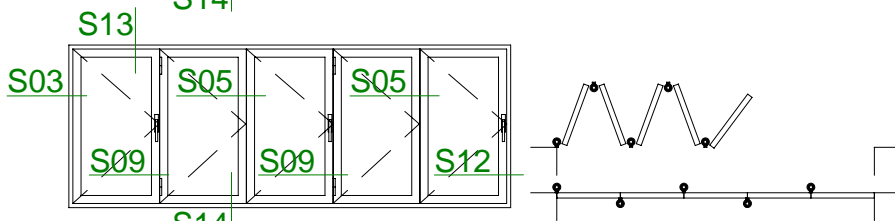
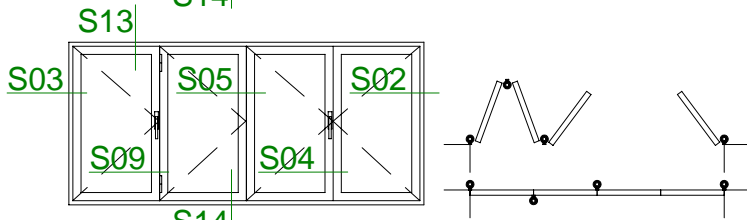
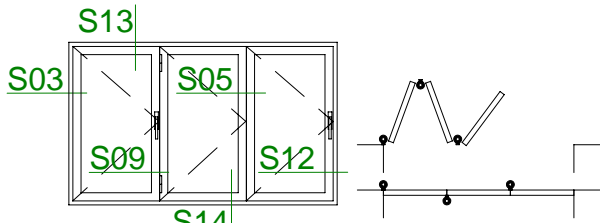

mallorquina

mallorquinas correderas

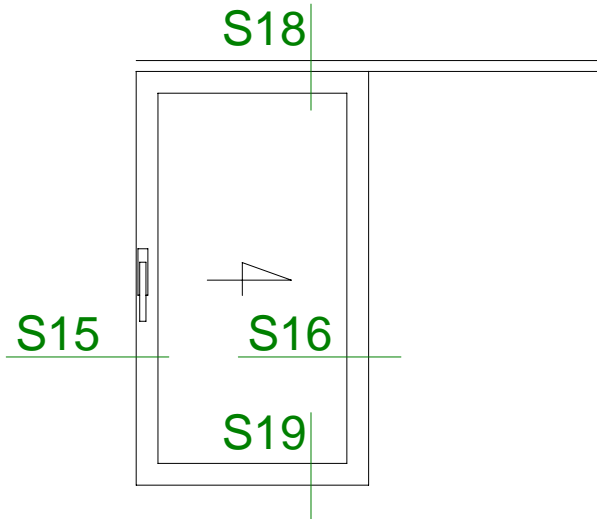

19

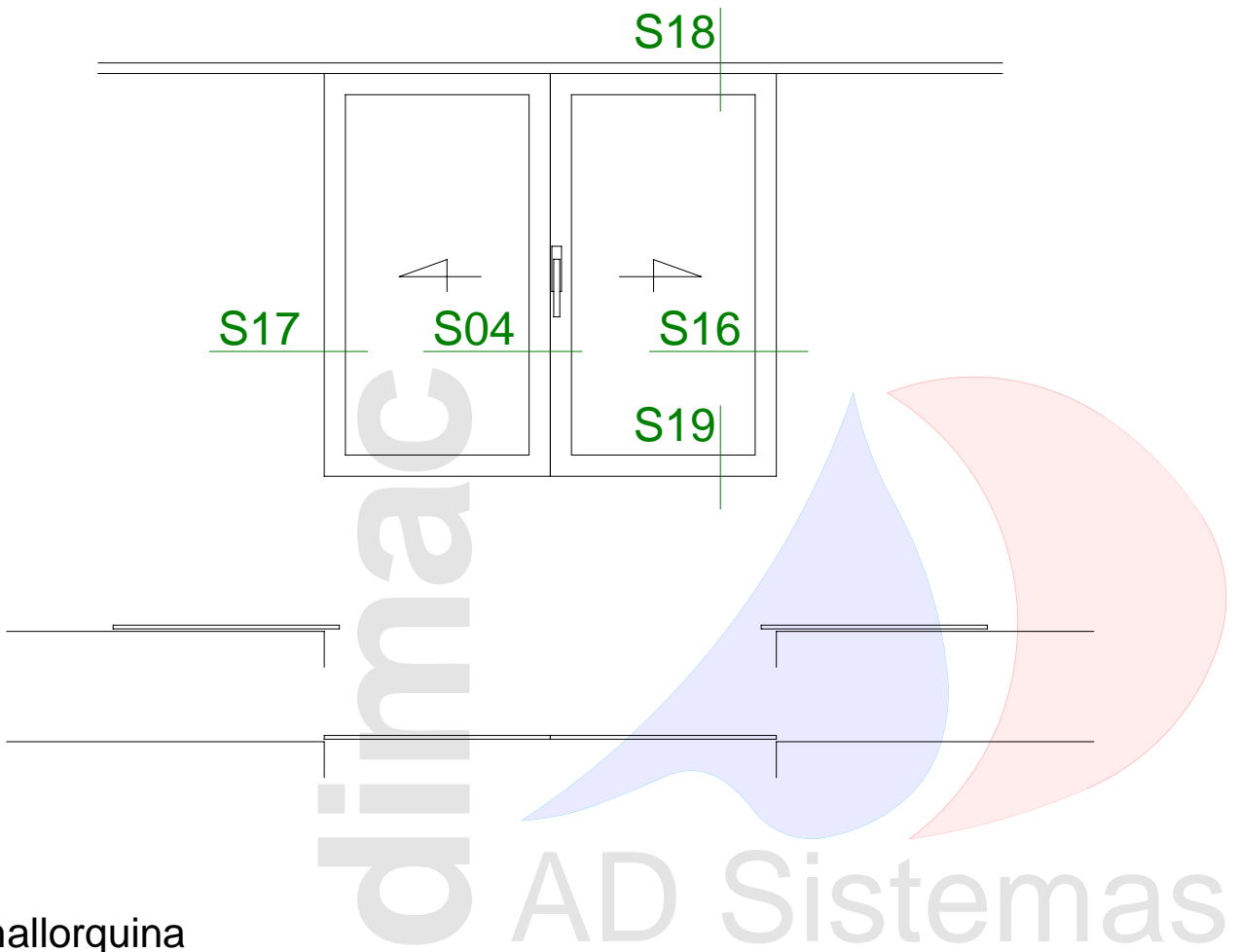

mallorquina

# S01

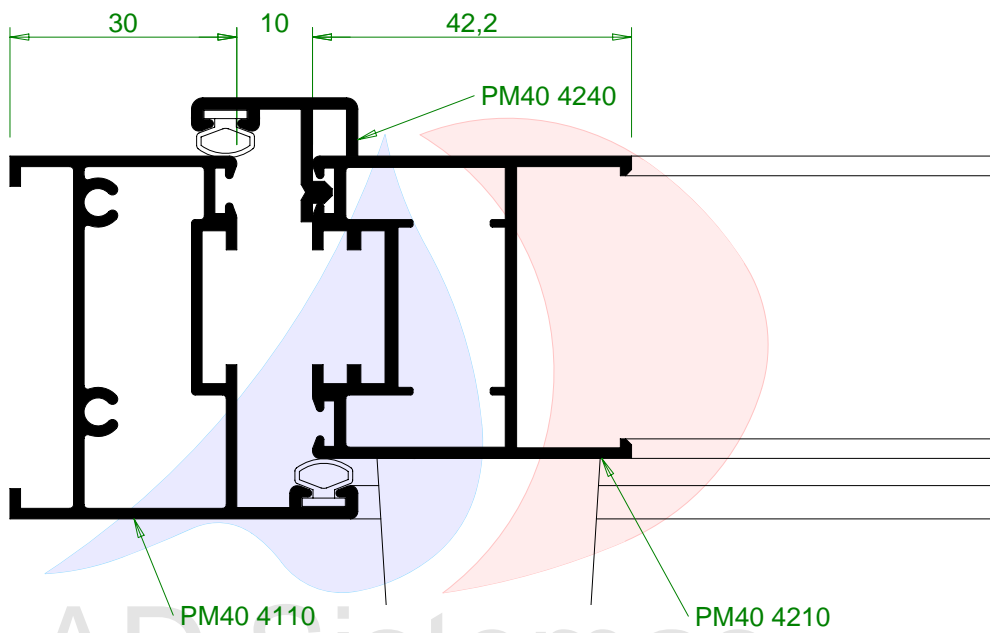
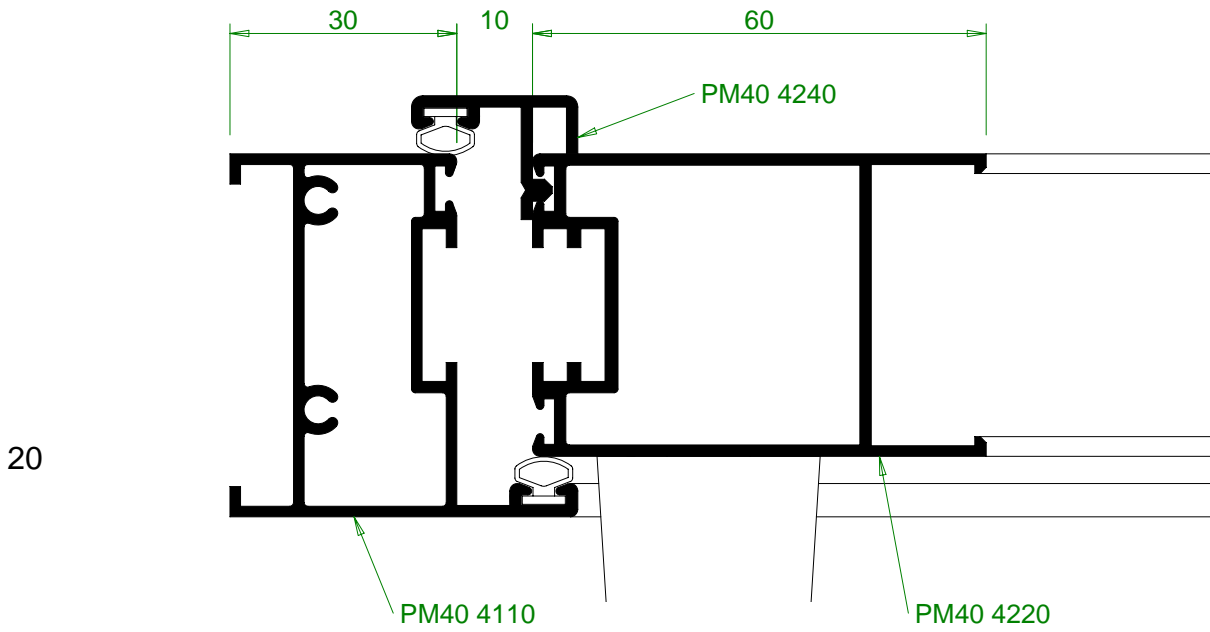
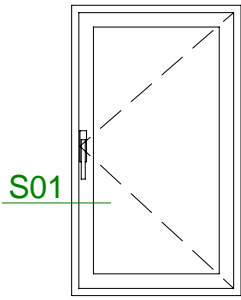

dimac  
AD Sistemas

mallorquina

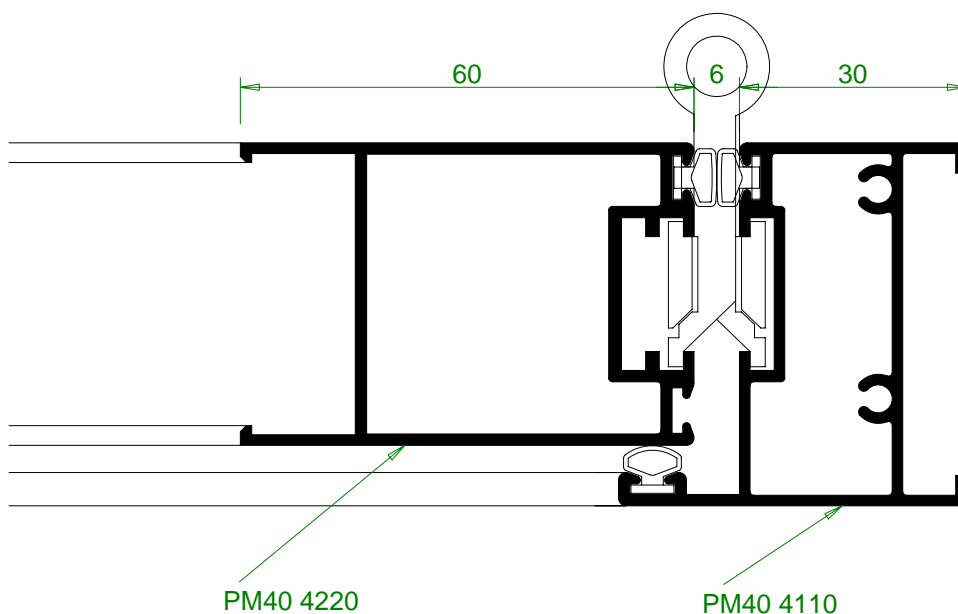
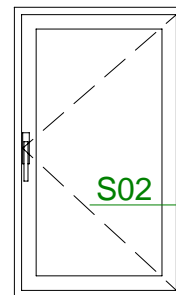

21

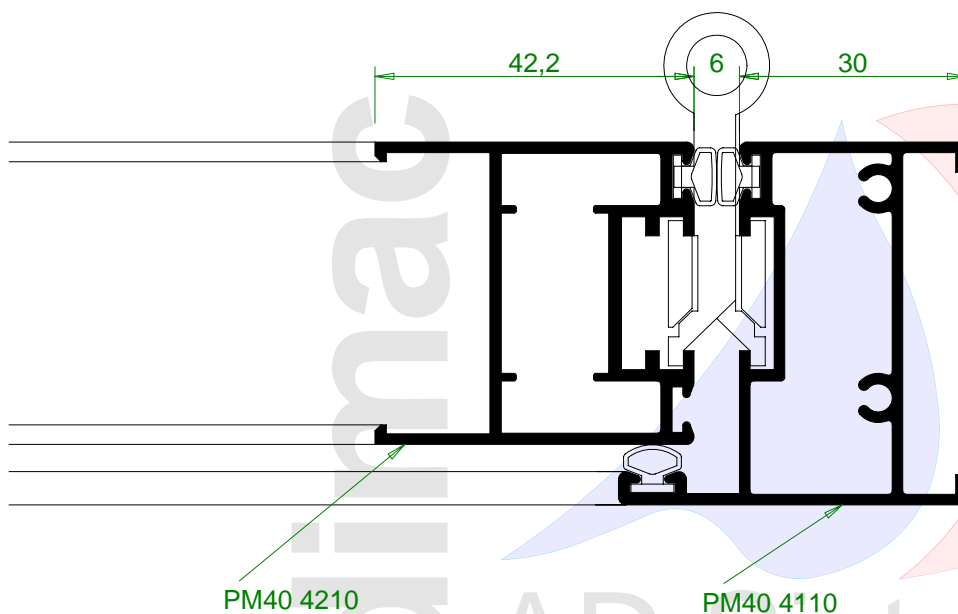

# S03

secciones

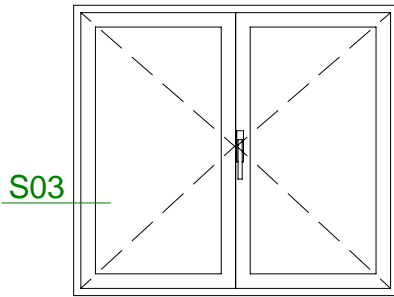

22

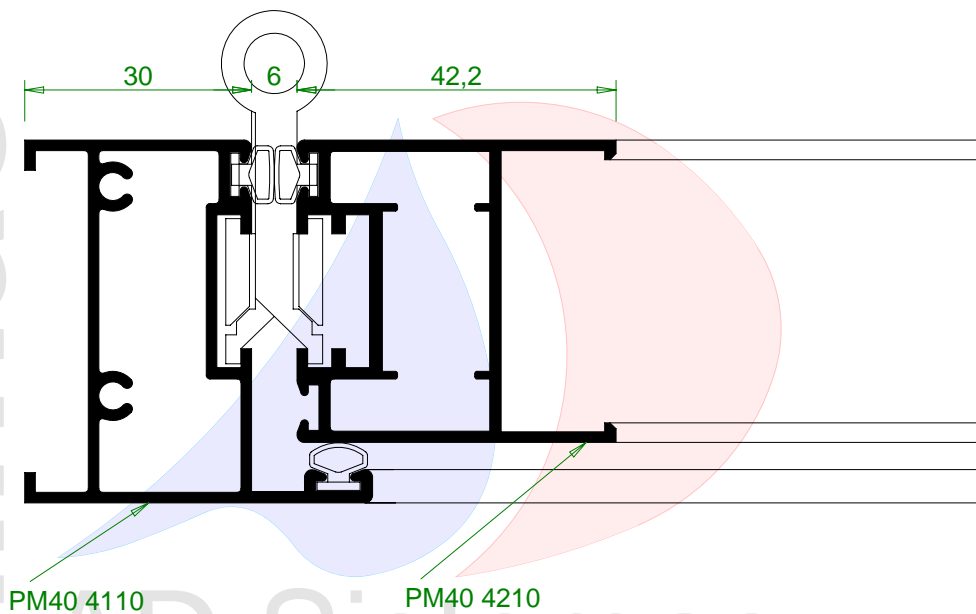
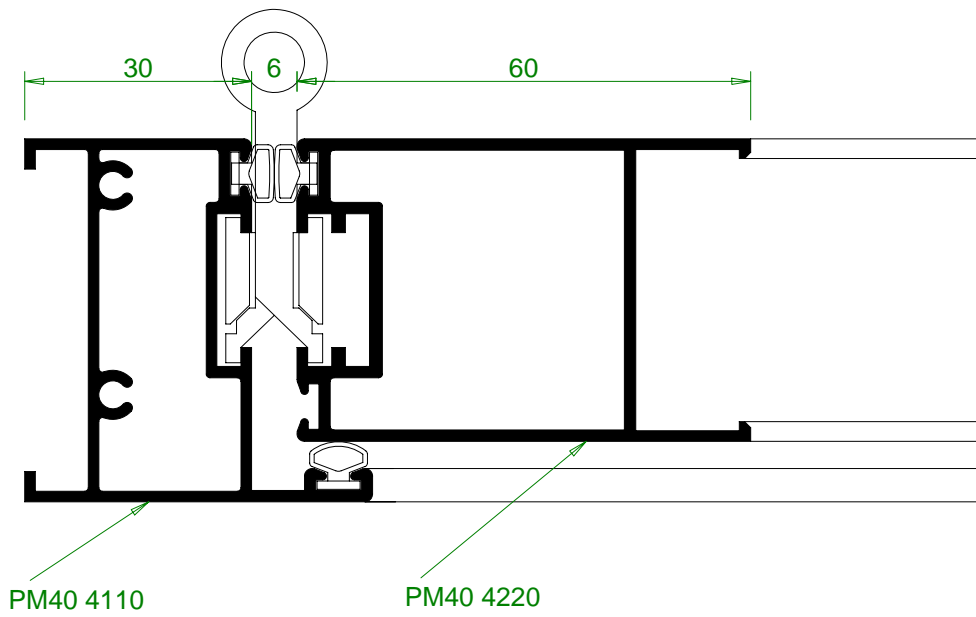

mallorquina

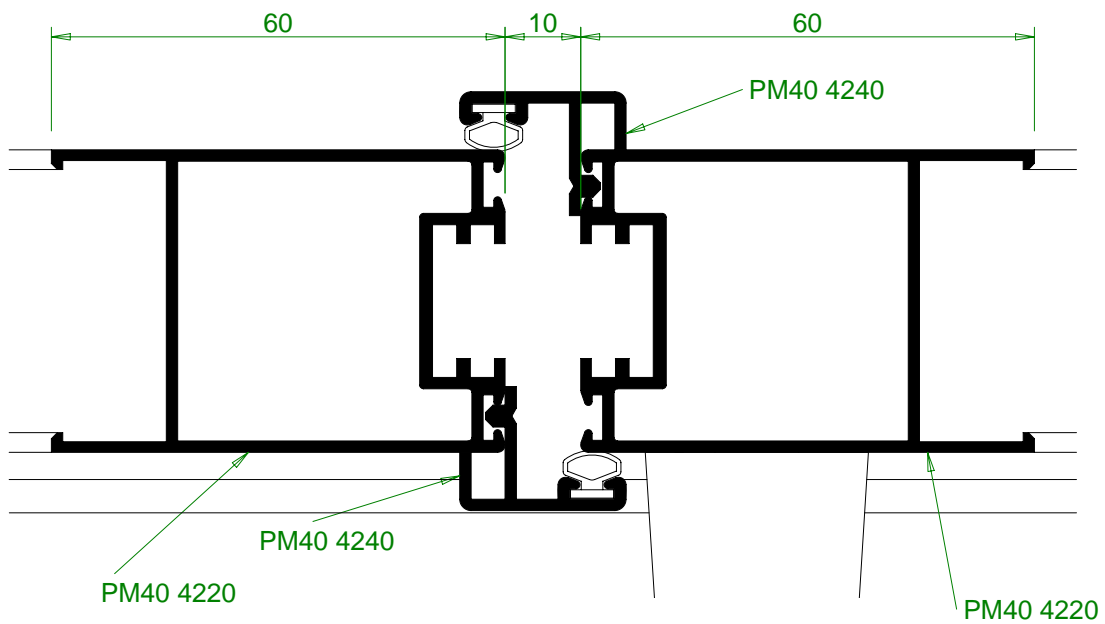
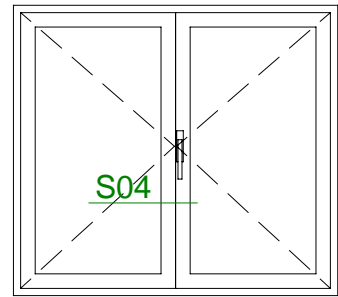

23

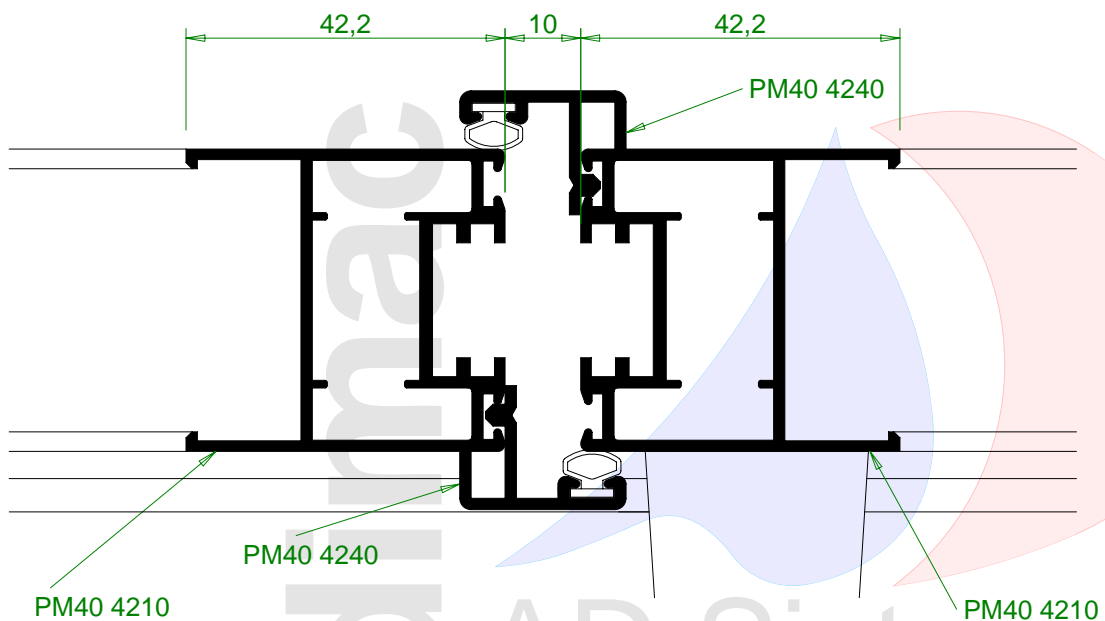

mallorquina

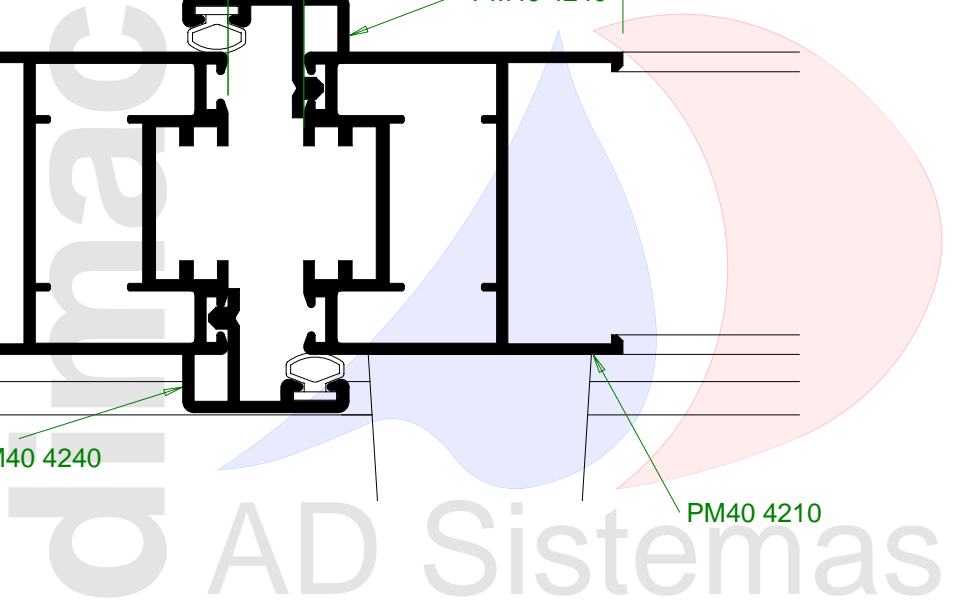

# S05

secciones

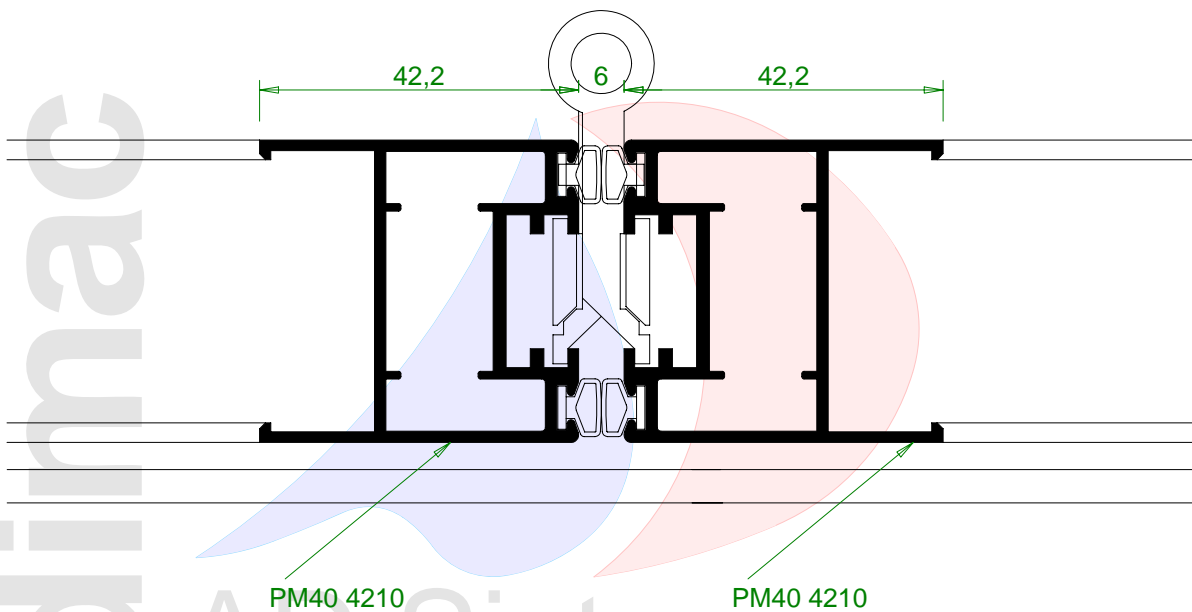
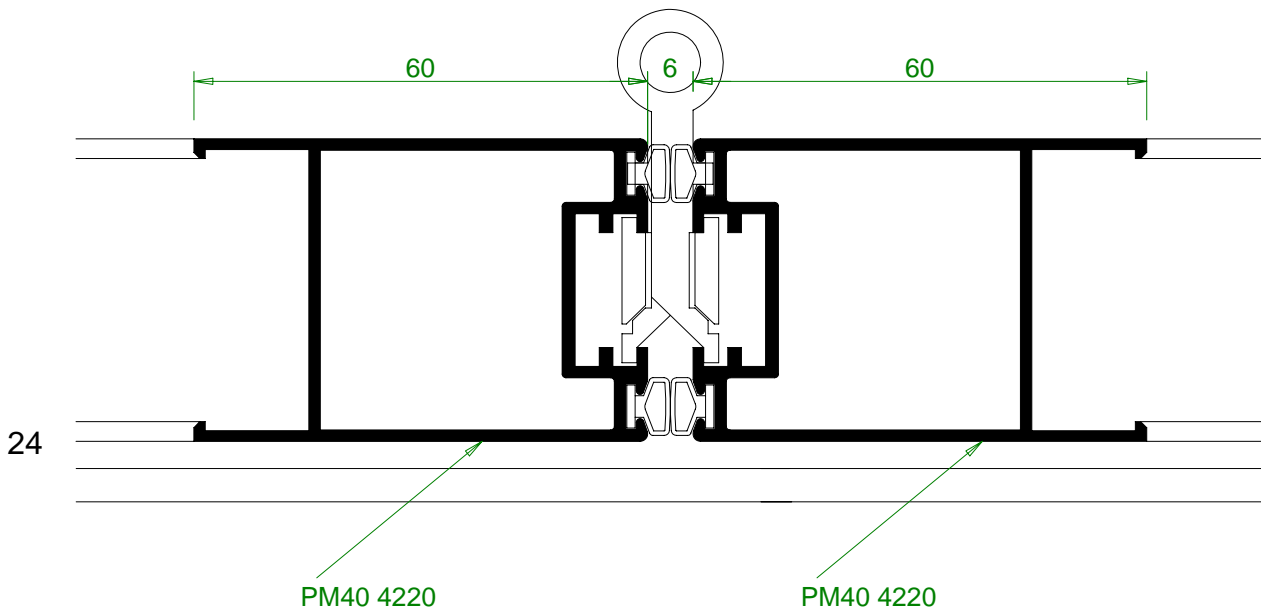
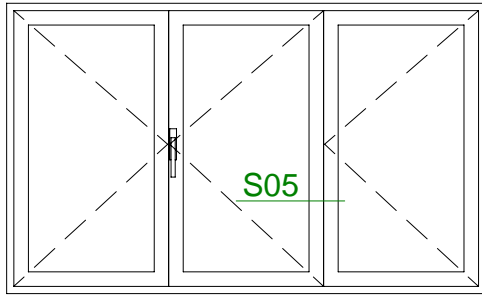

dimac  
AD Sistemas

mallorquina



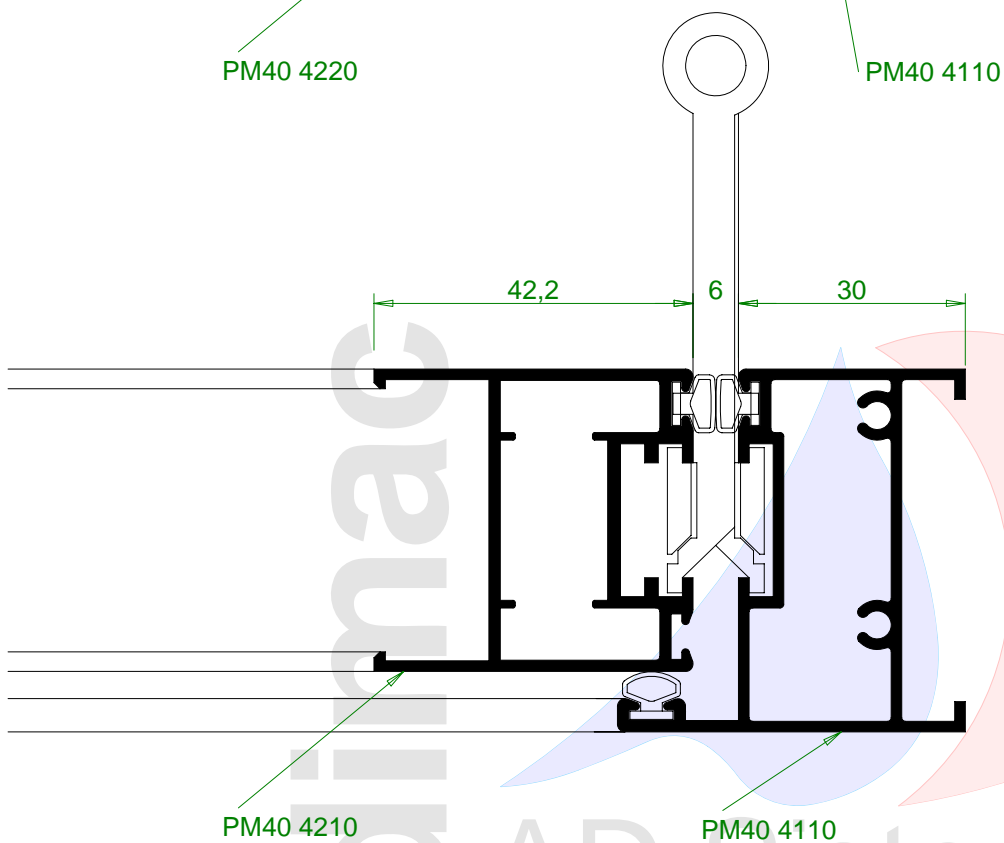
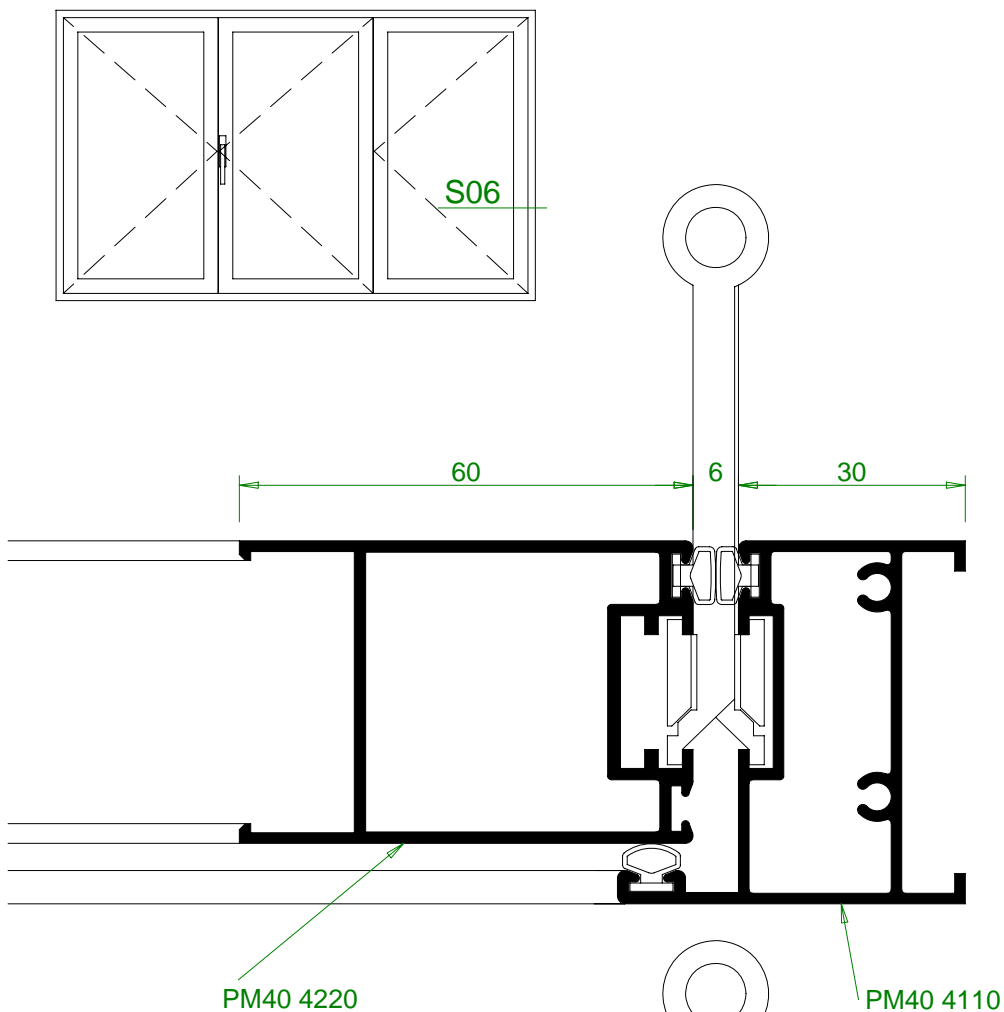

# S07

secciones

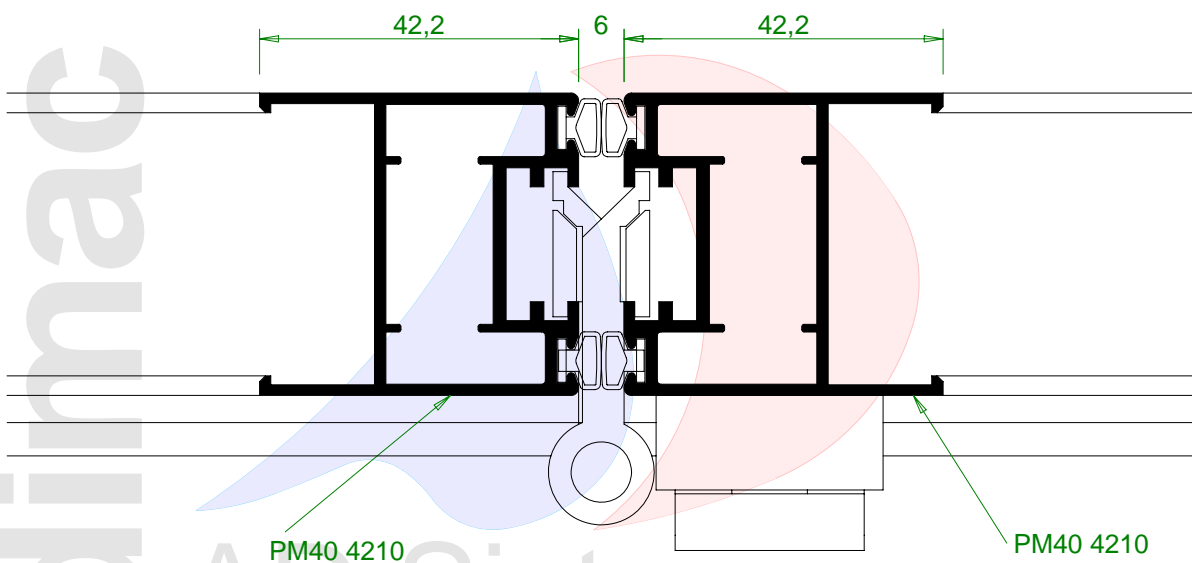
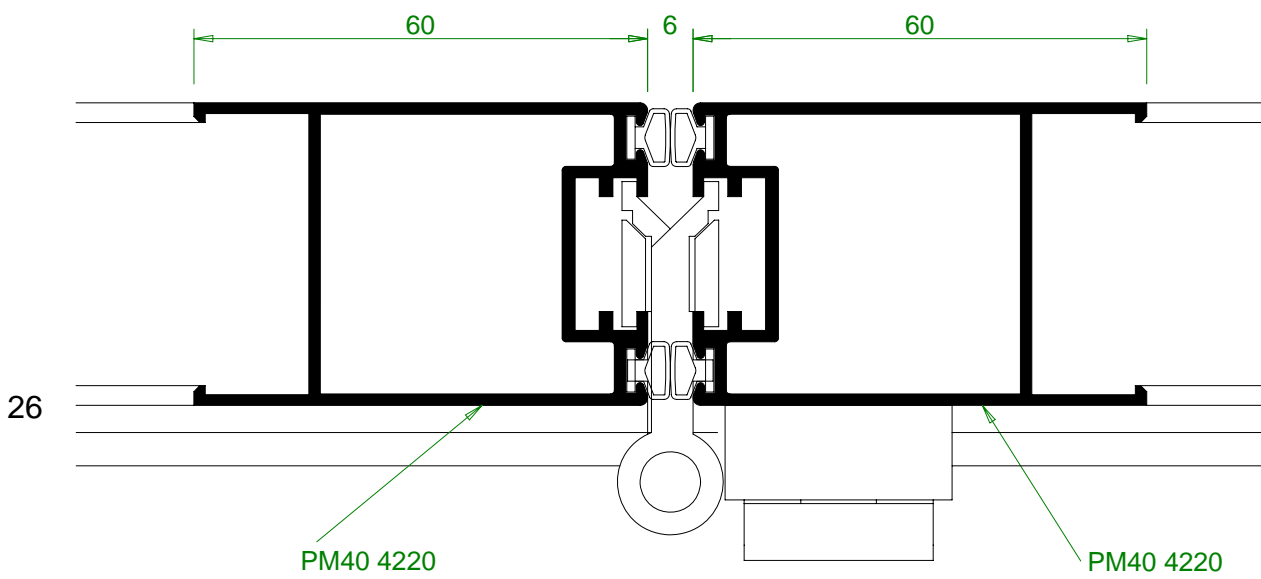
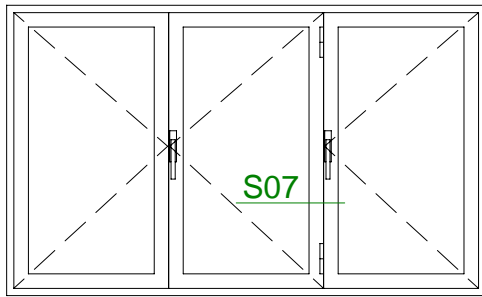

dimac  
AD Sistemas

mallorquina

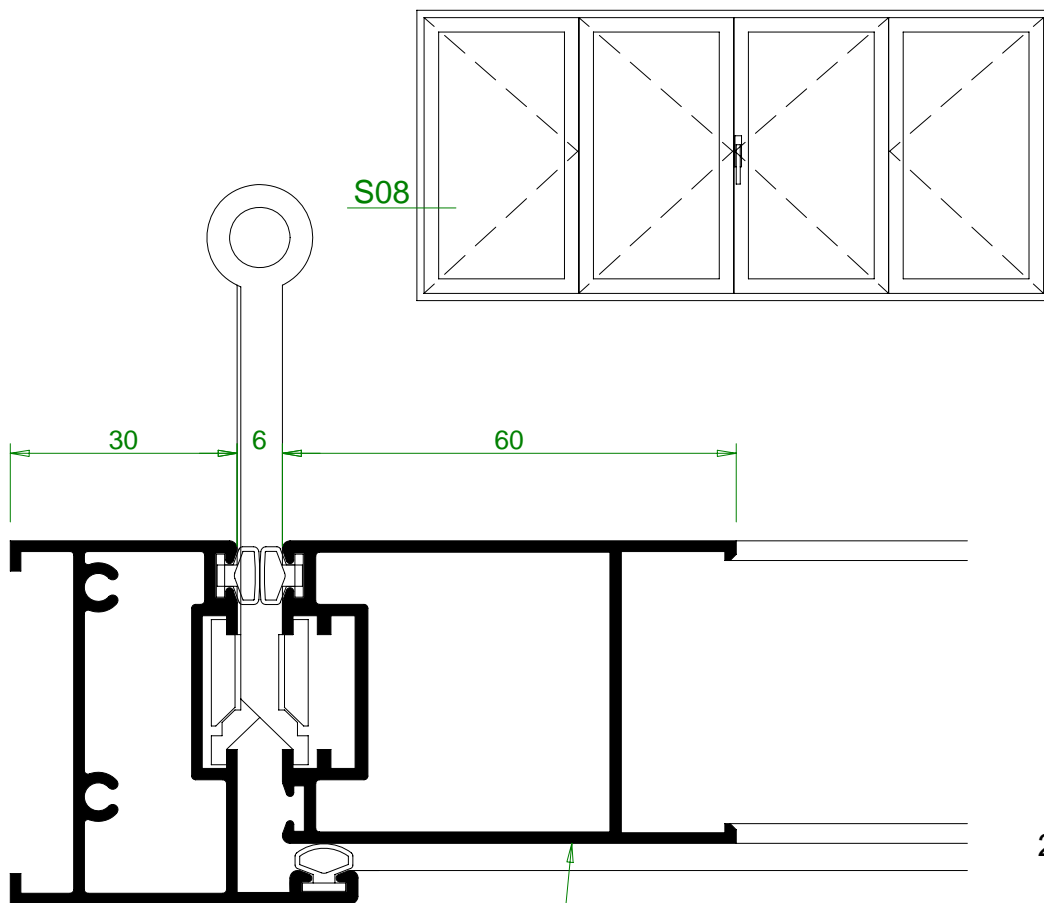

27

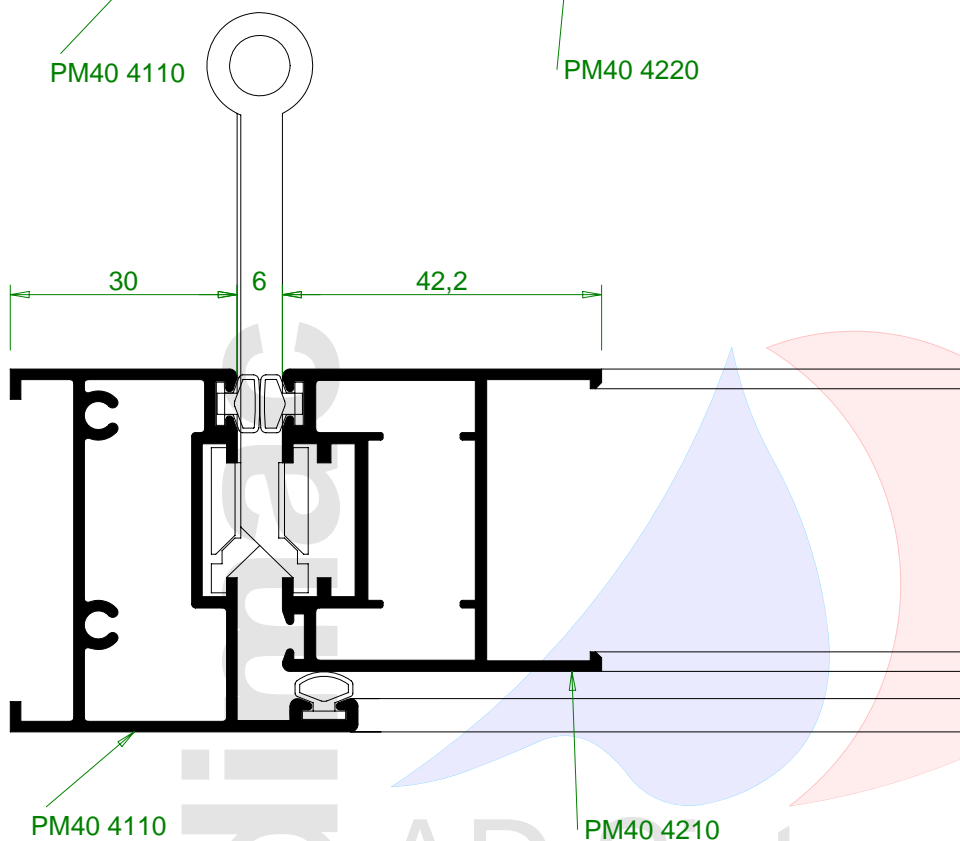

mallorquina

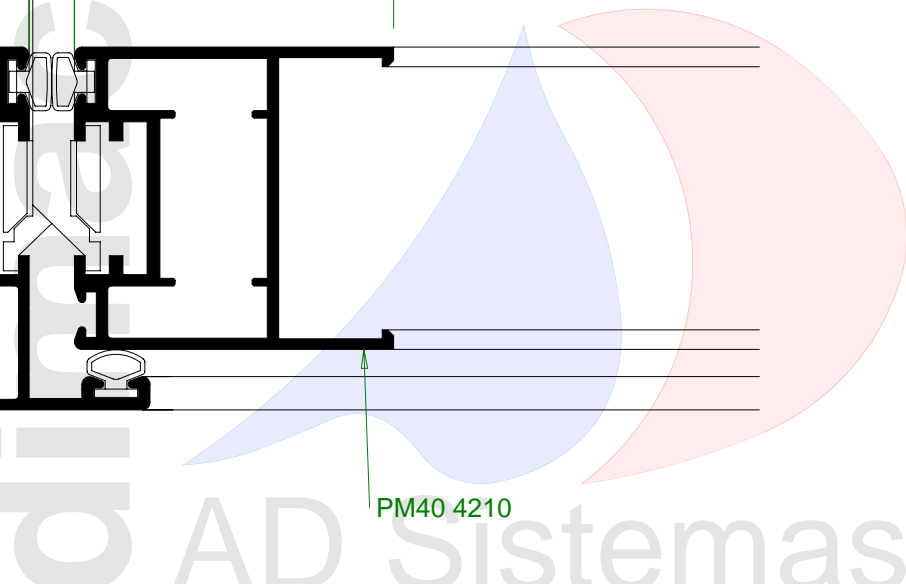

# S09

## secciones

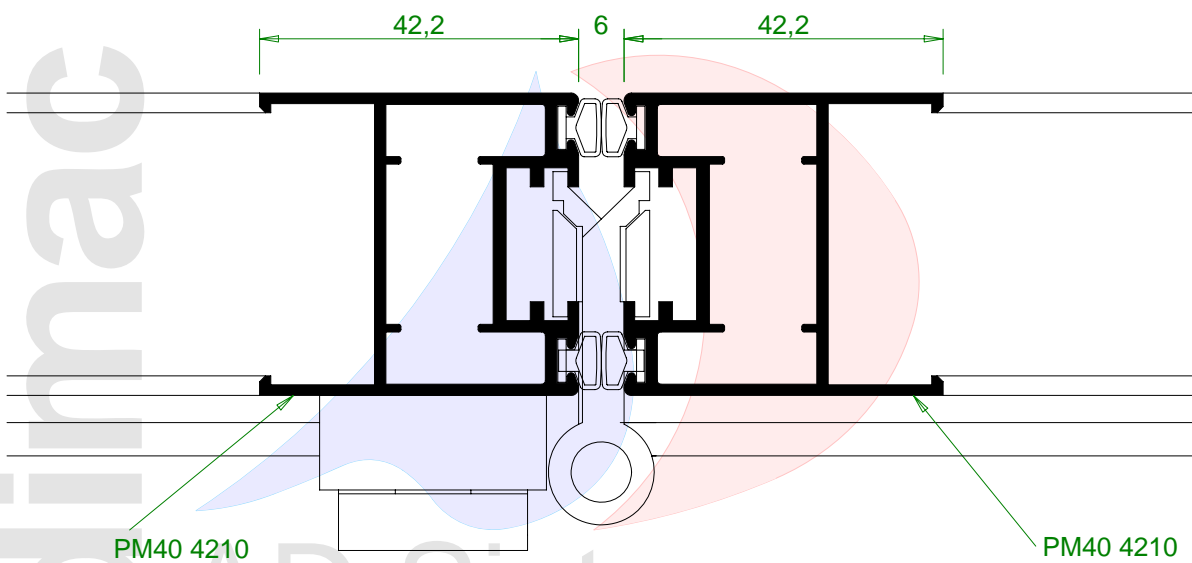
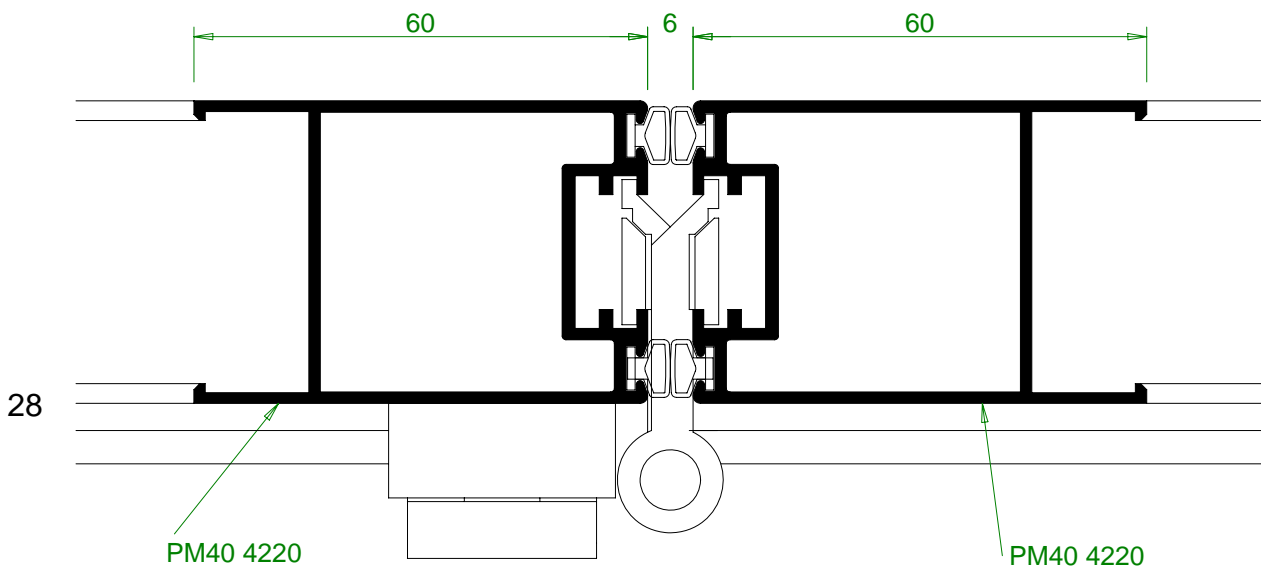
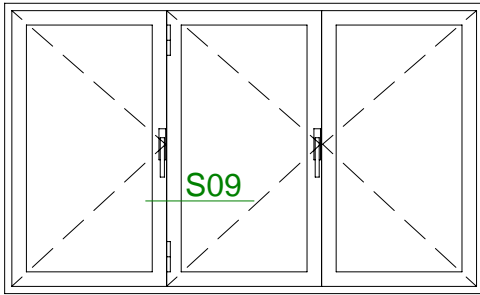

dinac  
AD Sistemas

mallorquina

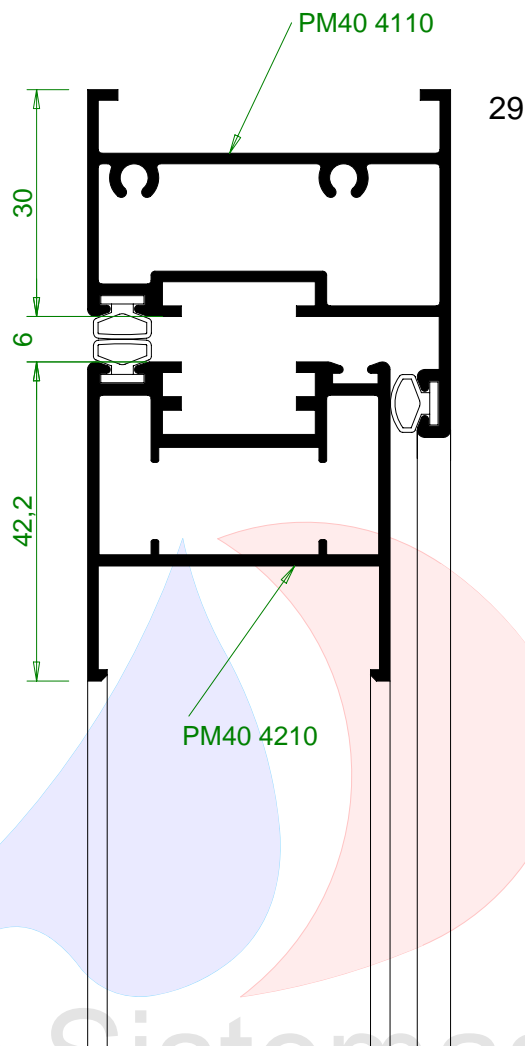
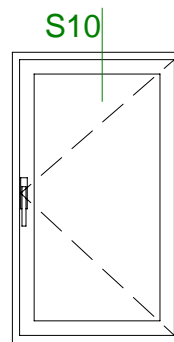
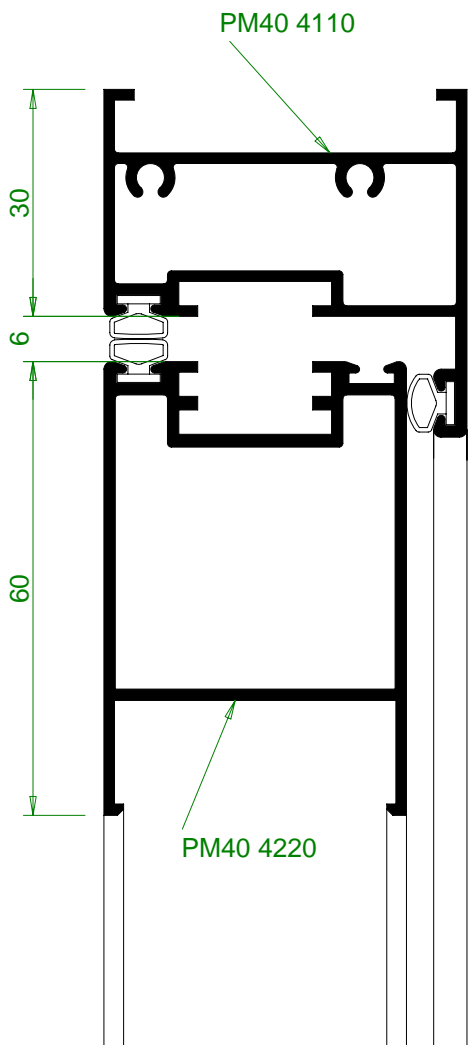

# S11

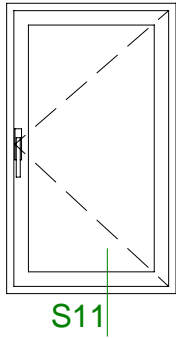

30

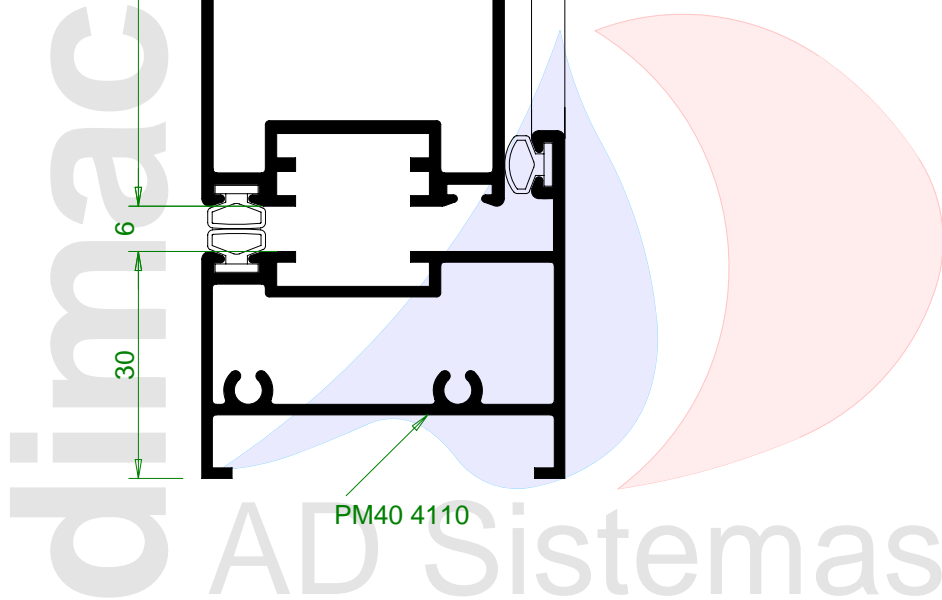
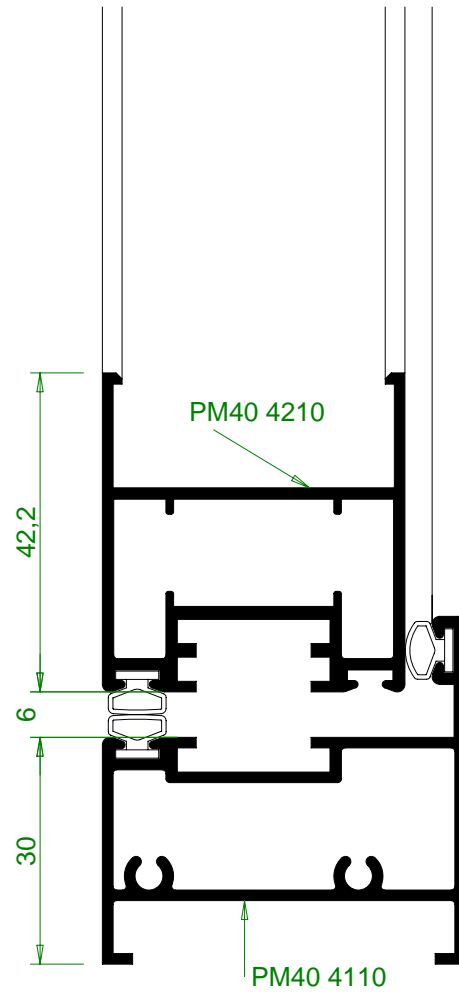
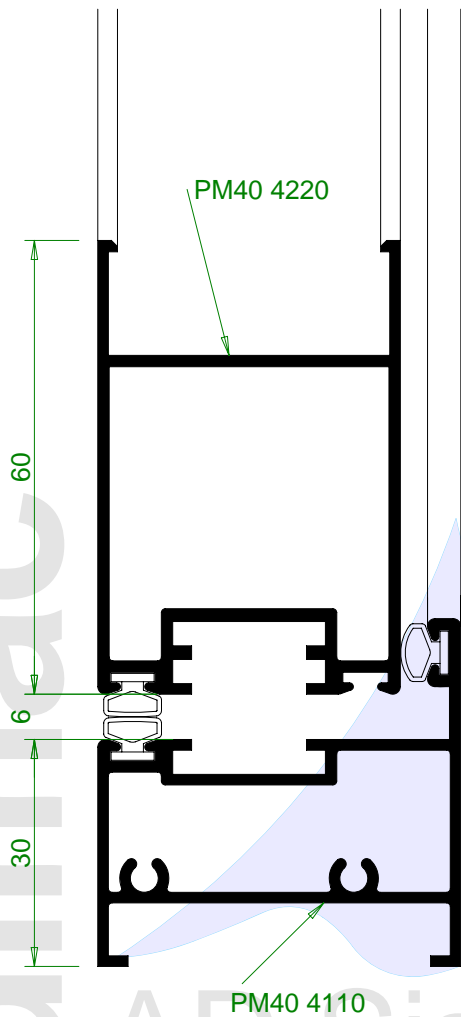

mallorquina

# S11 sin retornar

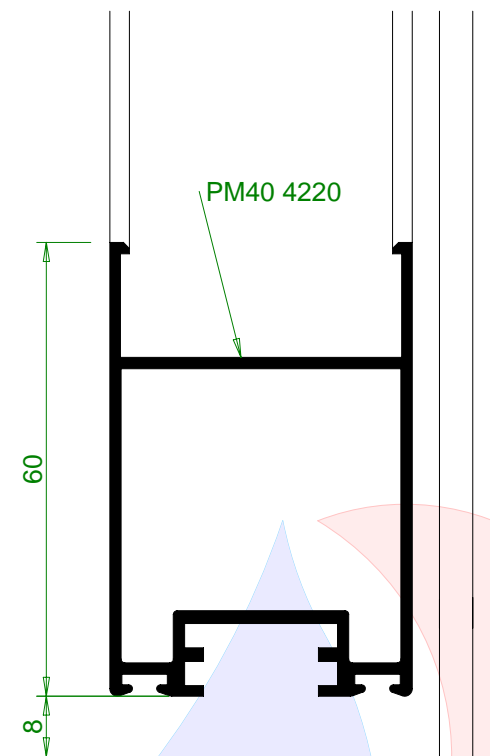
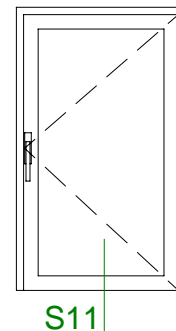
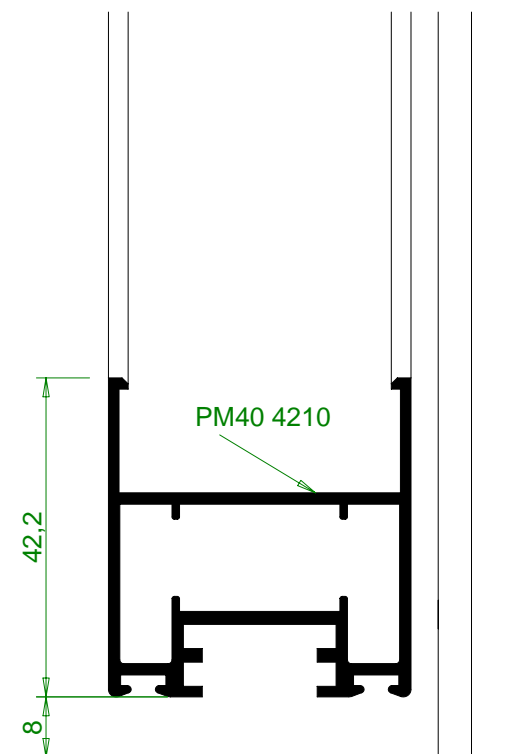

31

# S12

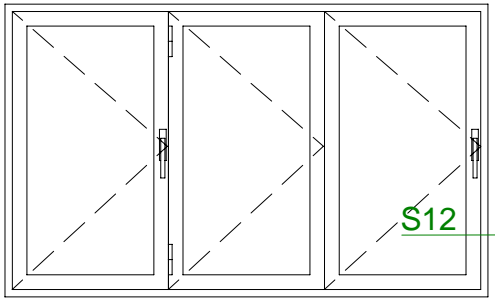

32

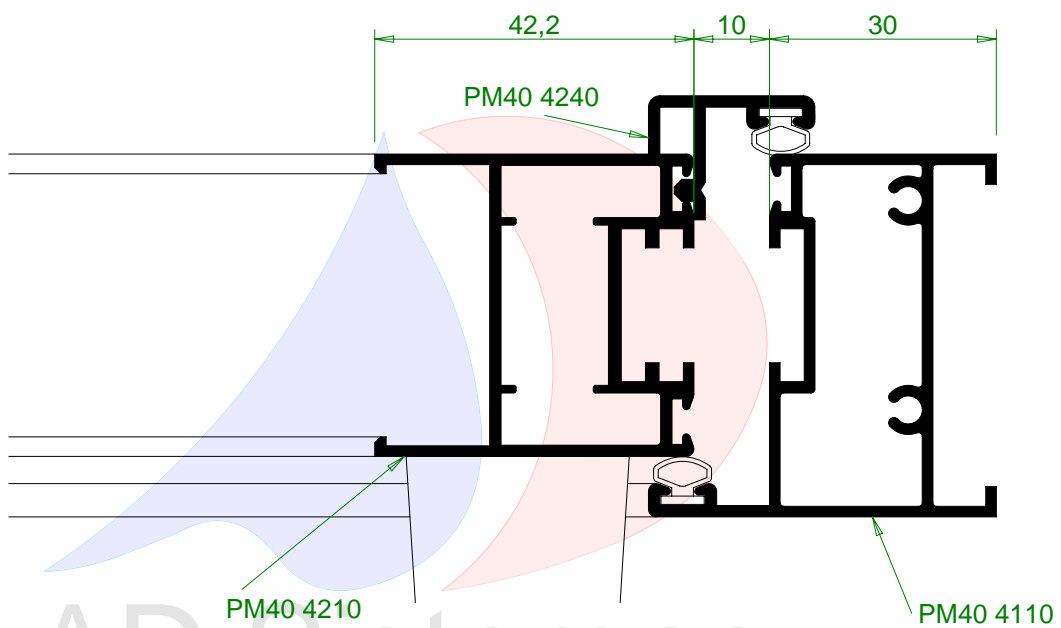
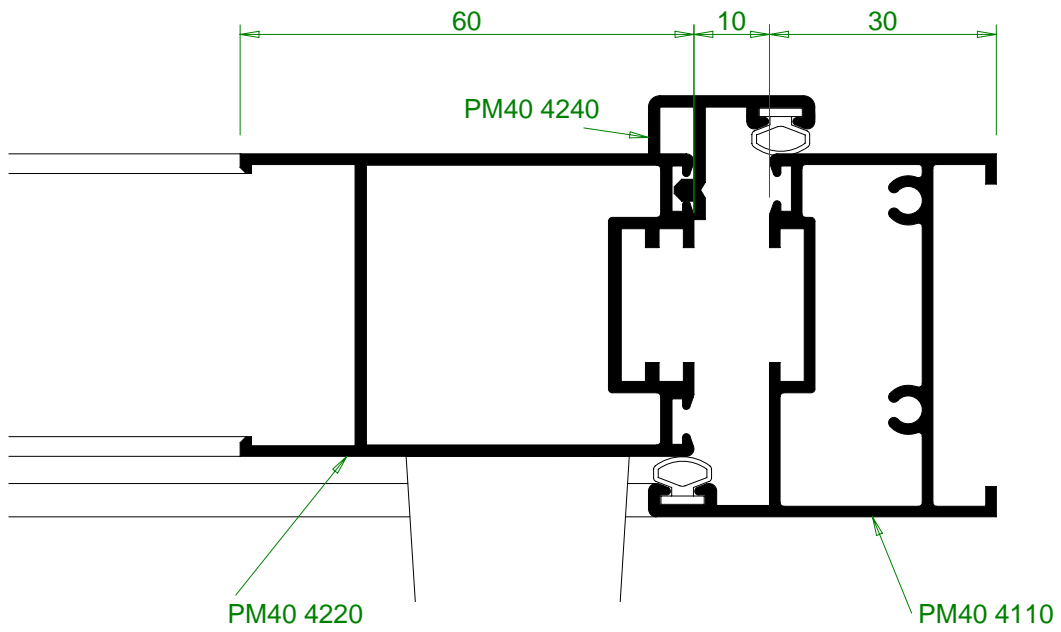

dimac  
AD Sistemas

mallorquina



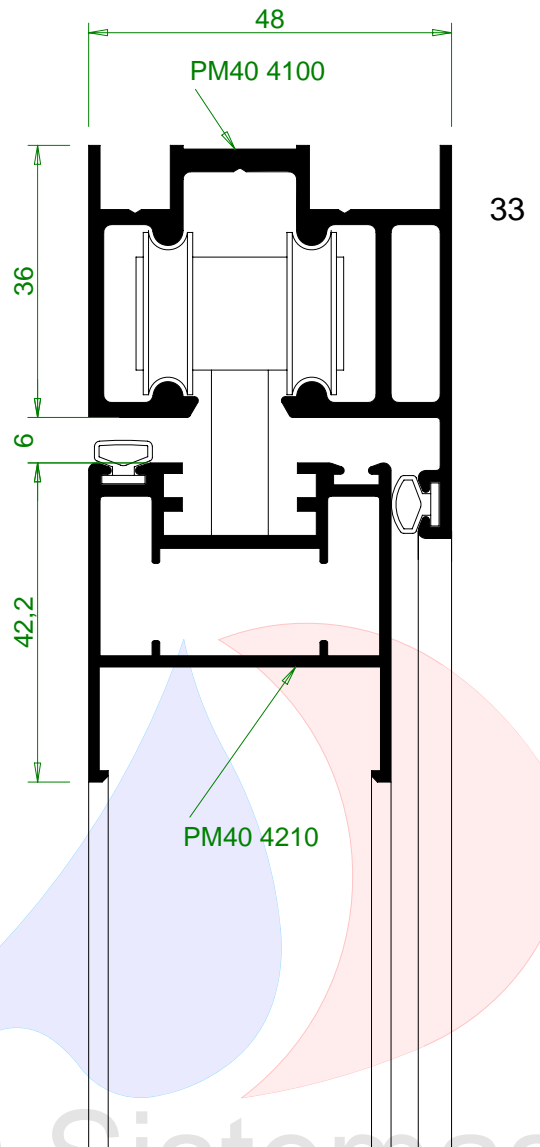
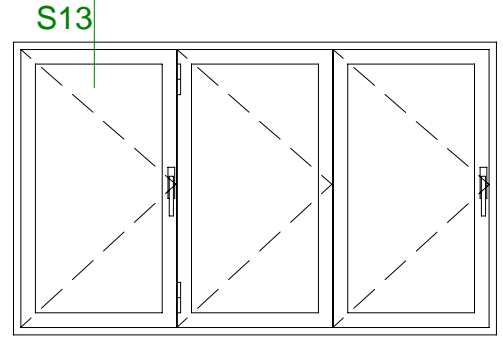
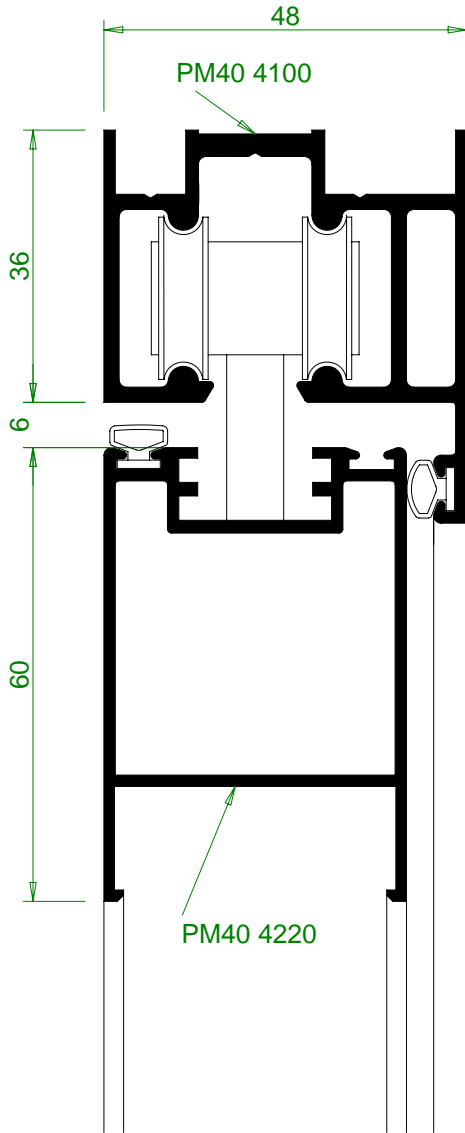

# S14 sobrepuesta

secciones

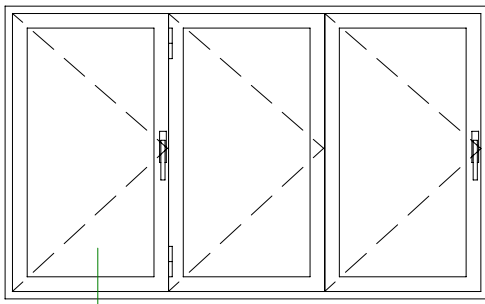

S14

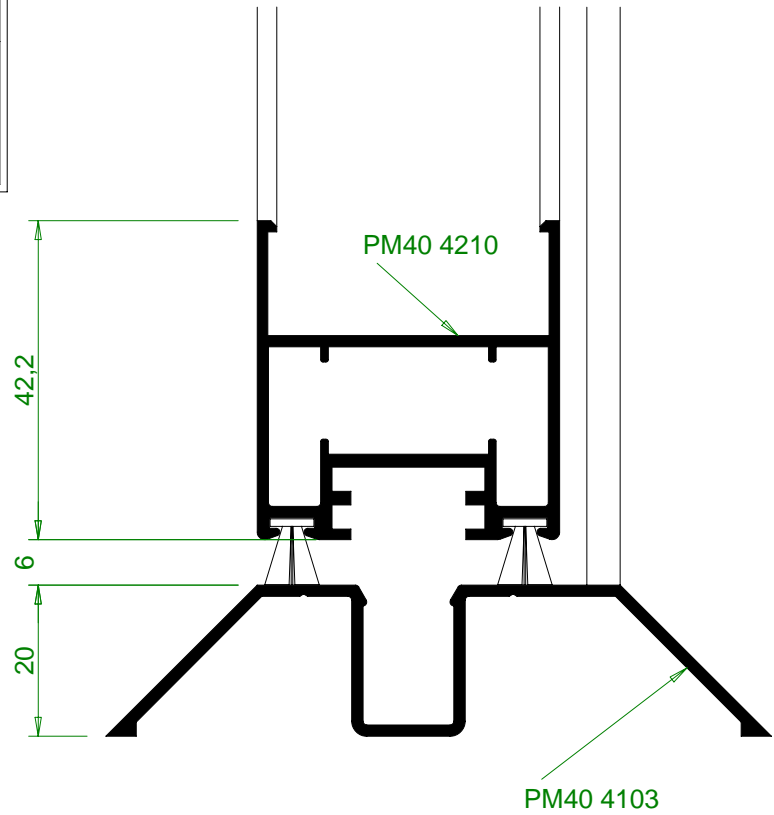

34

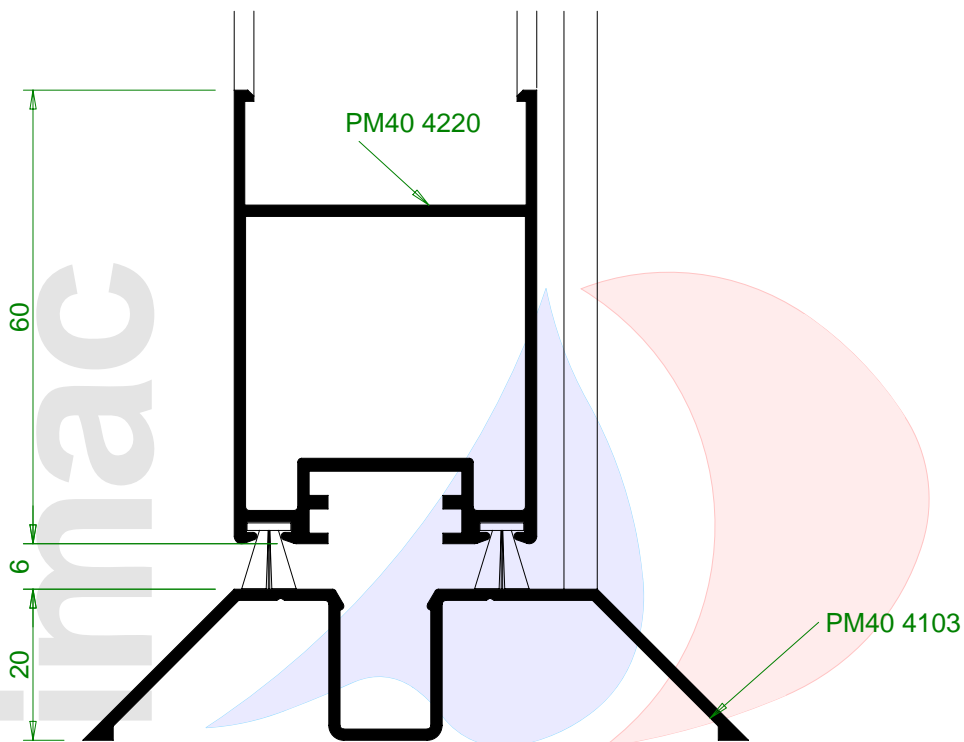

dimac

AD Sistemas

mallorquina

# S14 empotrada

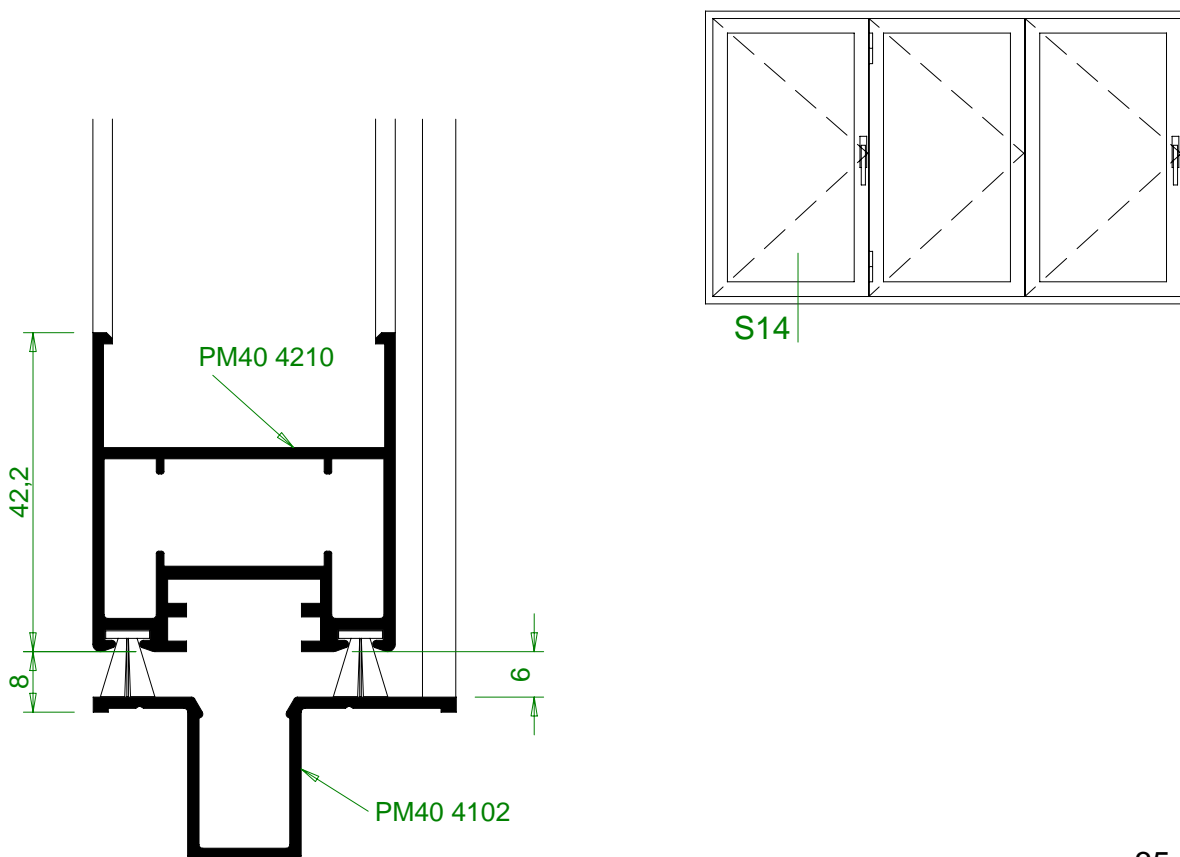

35

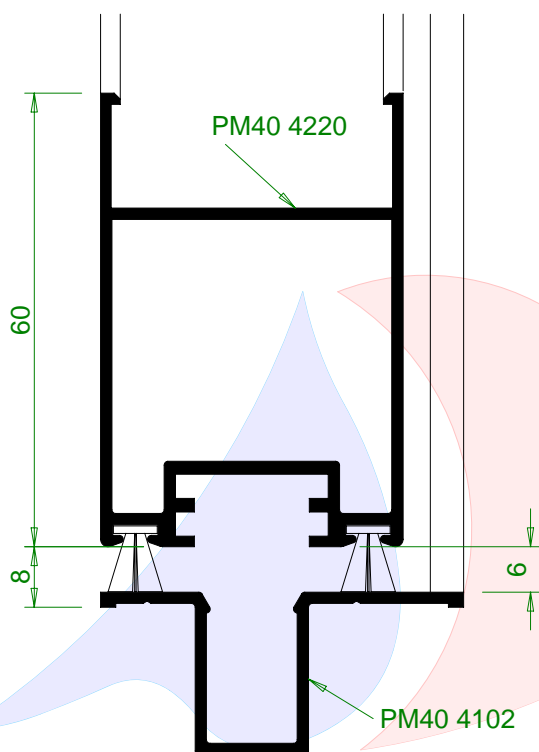

# S15

secciones

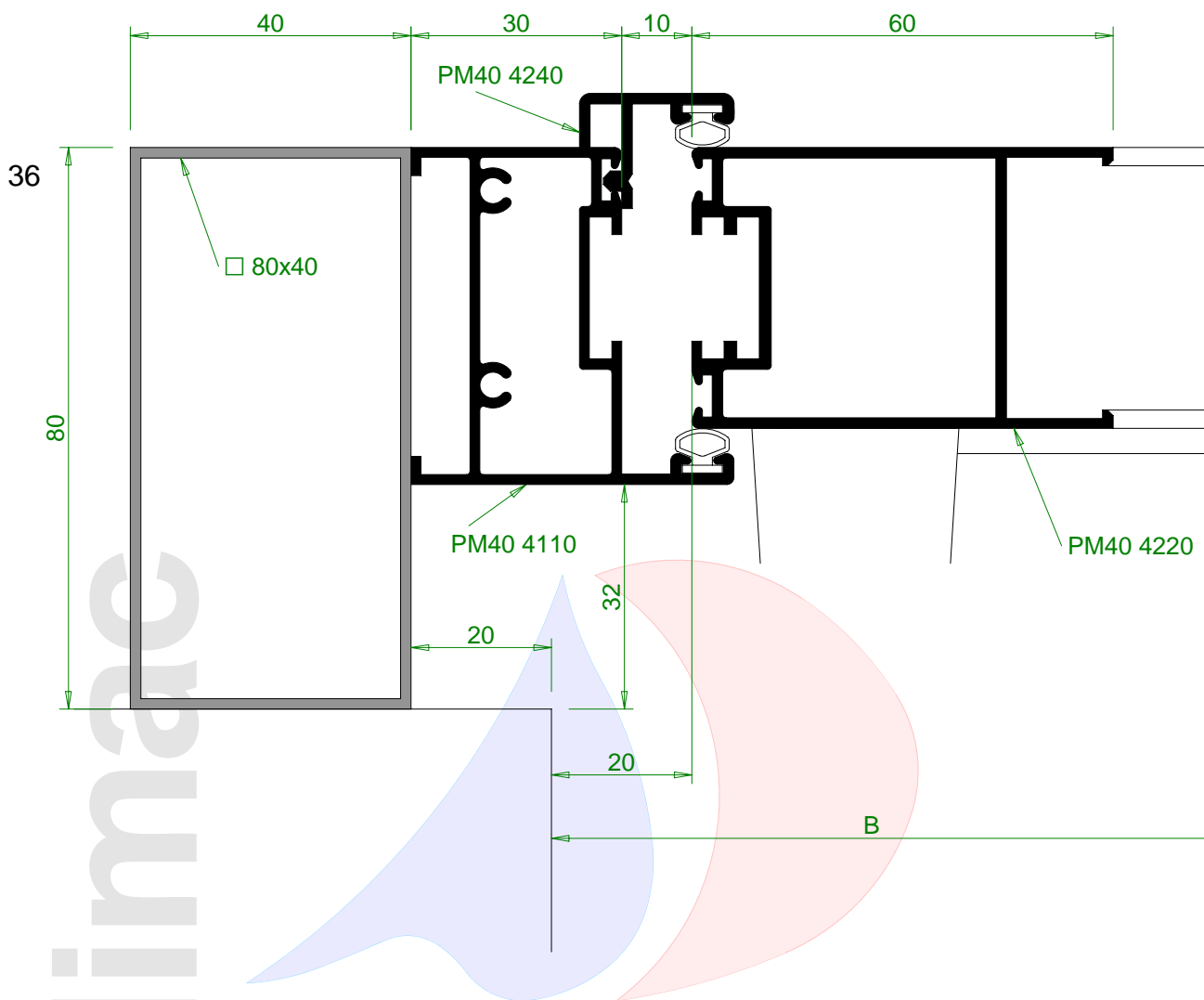
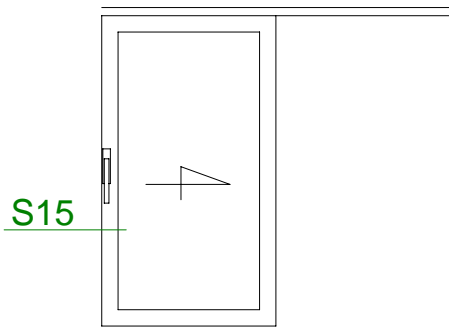

dimac

AD Sistemas

mallorquina

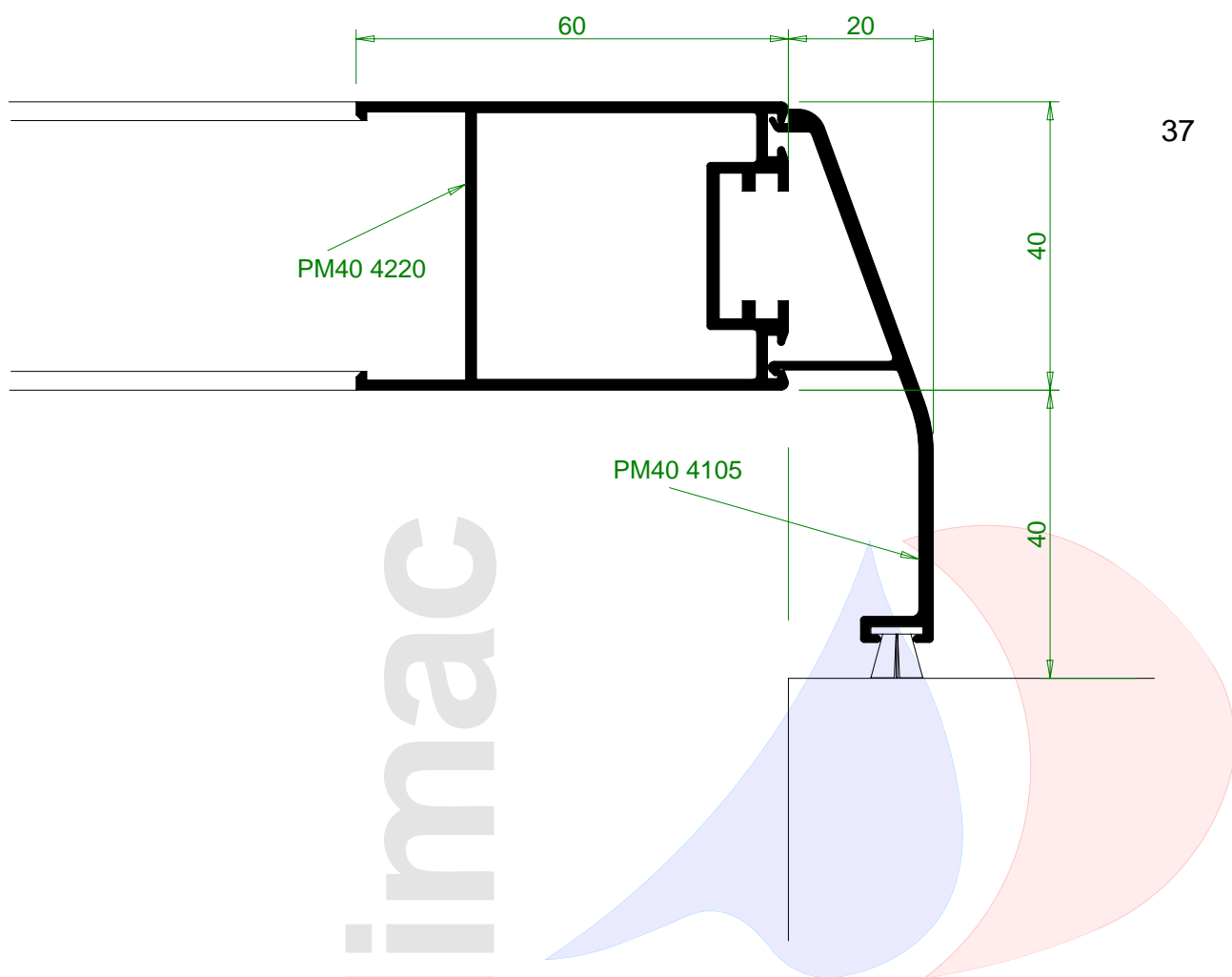
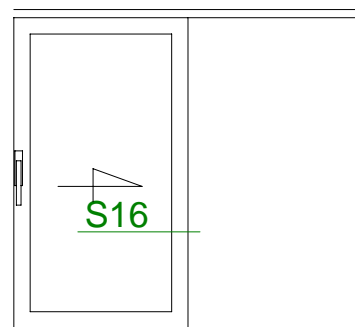

# S17

secciones

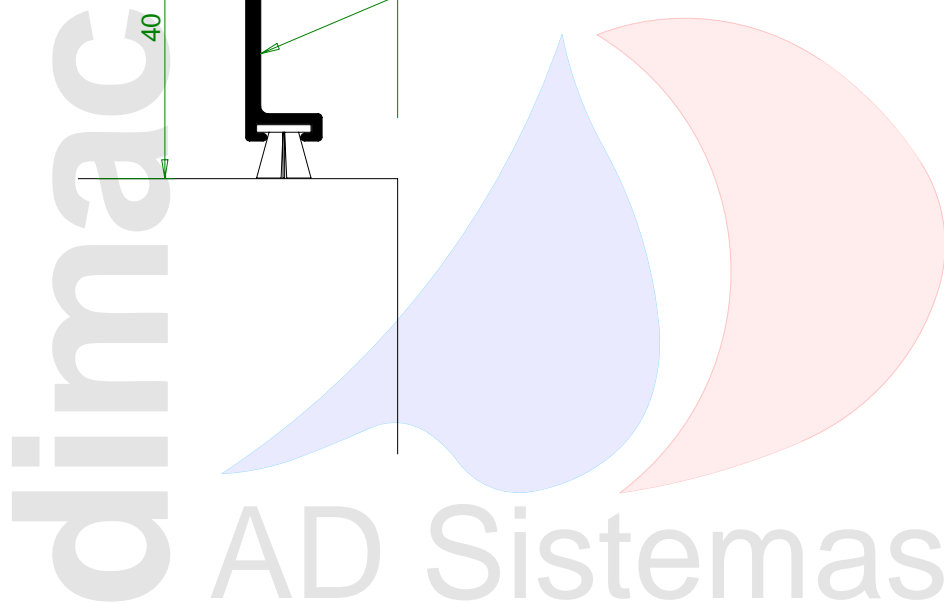
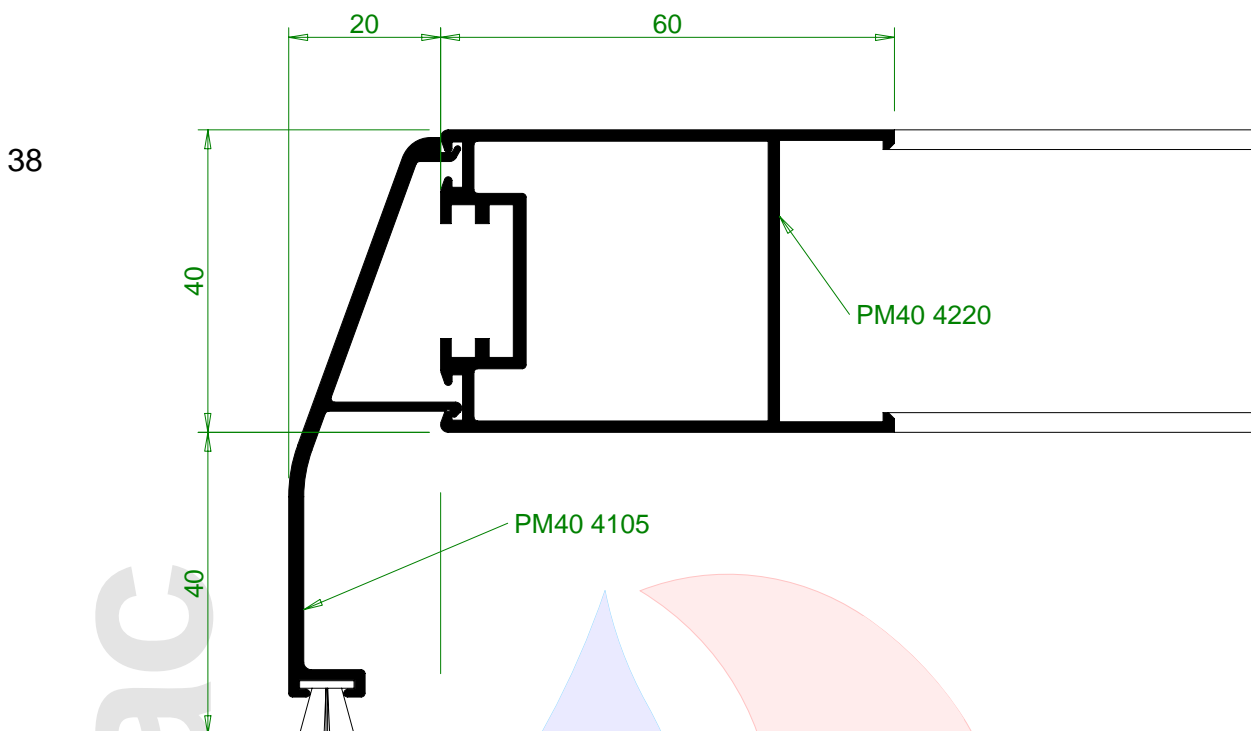
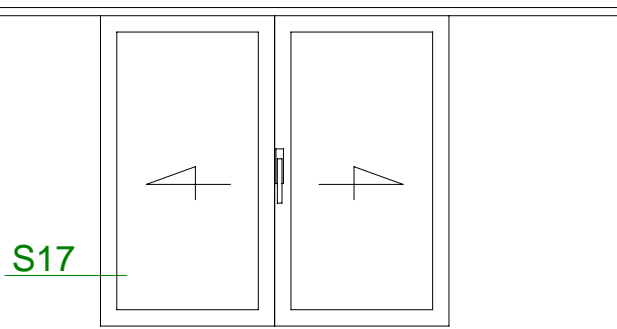

mallorquina

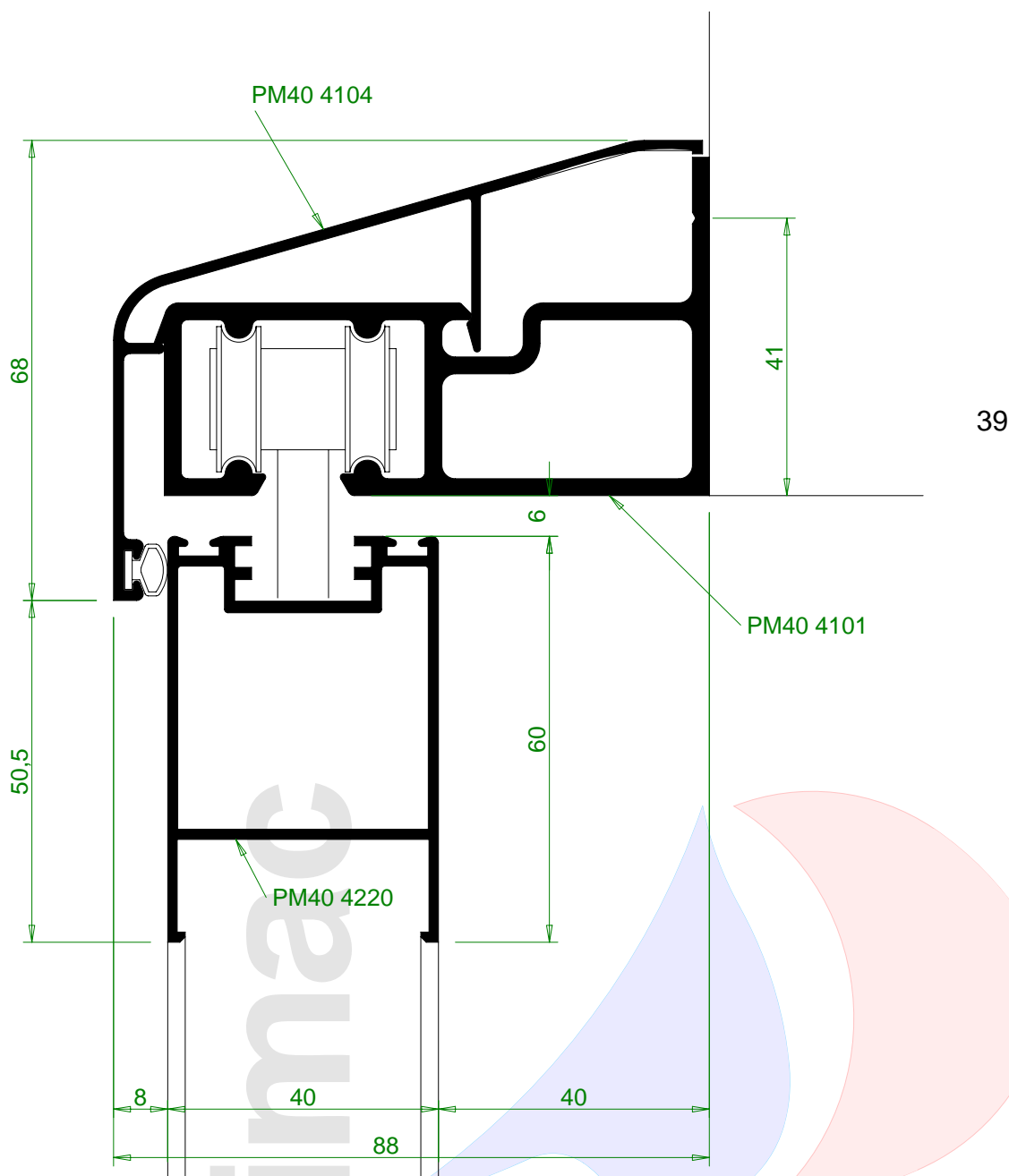
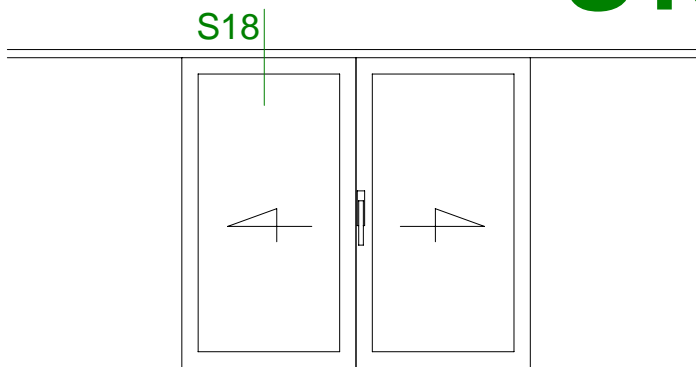

# S19 sobrepuesta

secciones

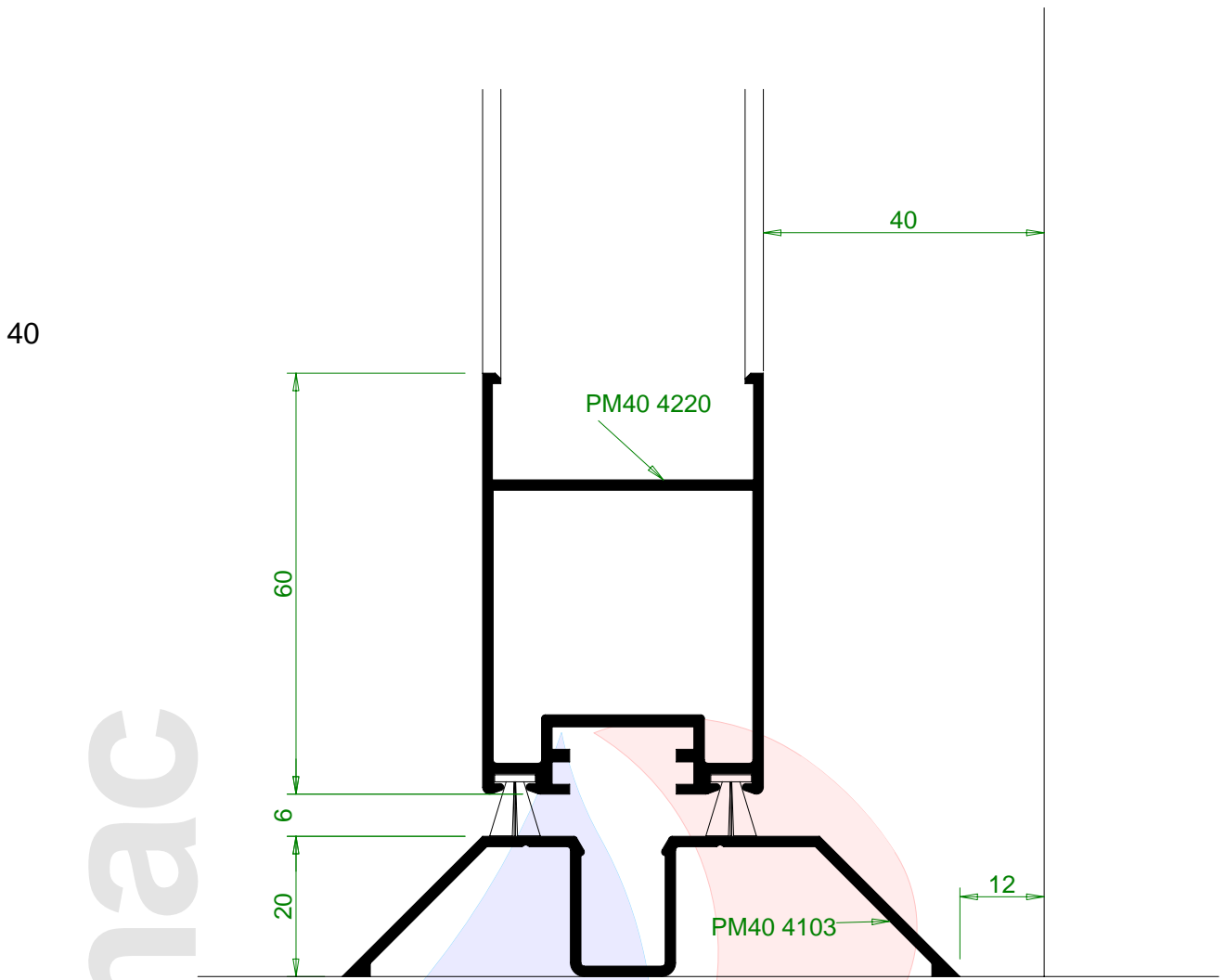
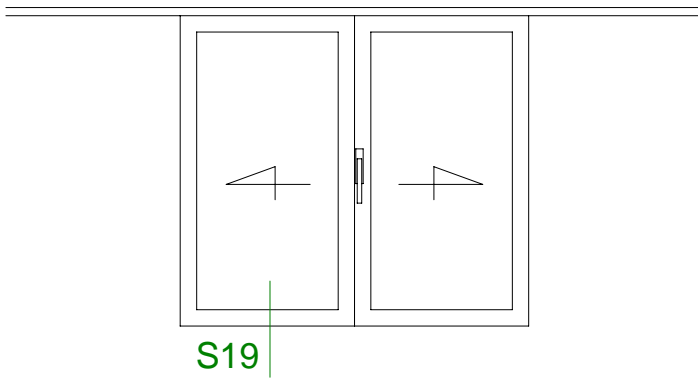

dimac  
AD Sistemas

mallorquina



# S19 empotrada

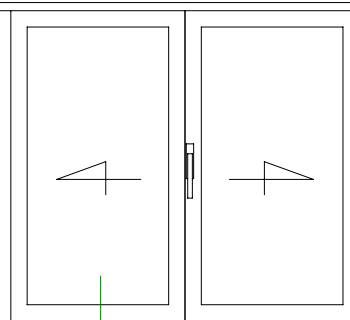

S19

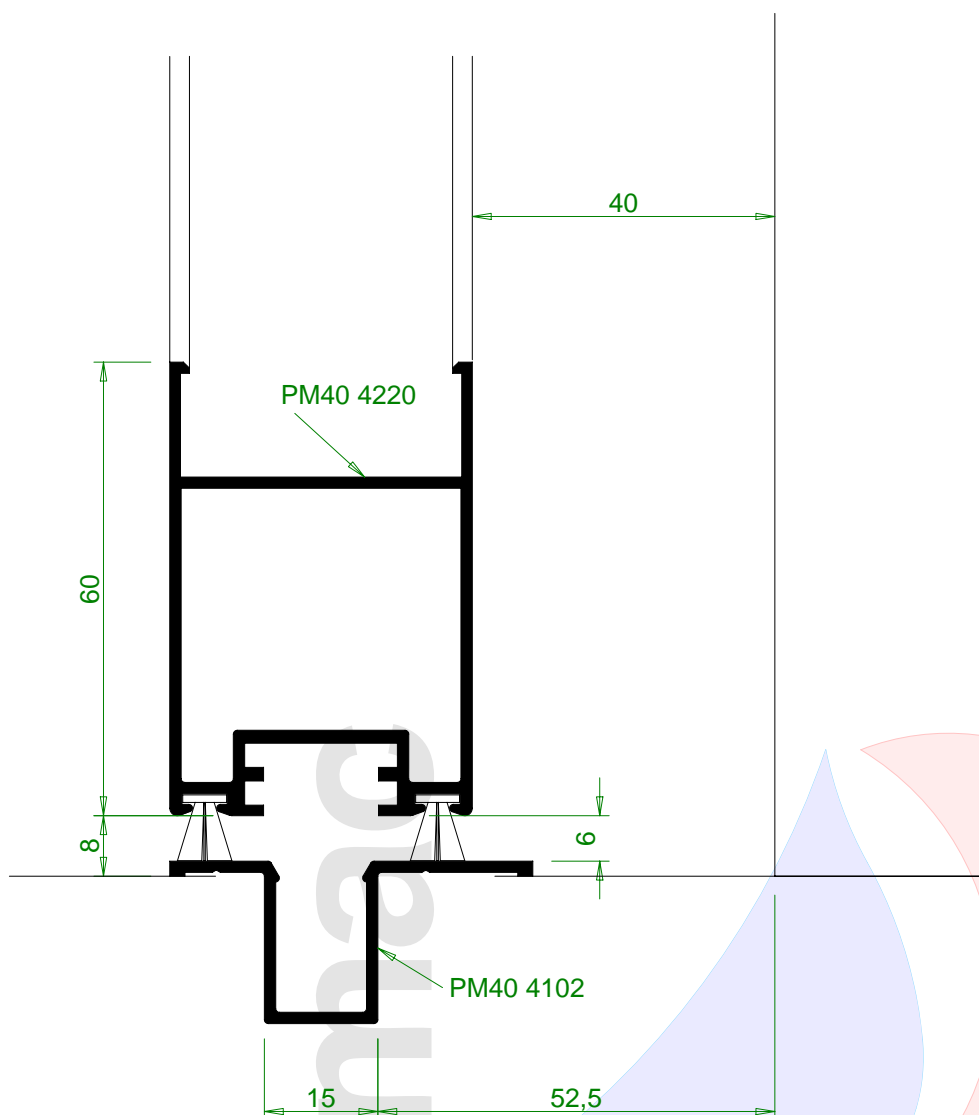

41

# S19 -colgada-

secciones

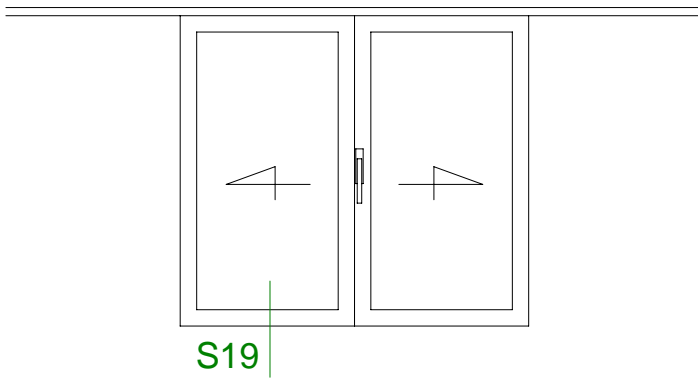

42

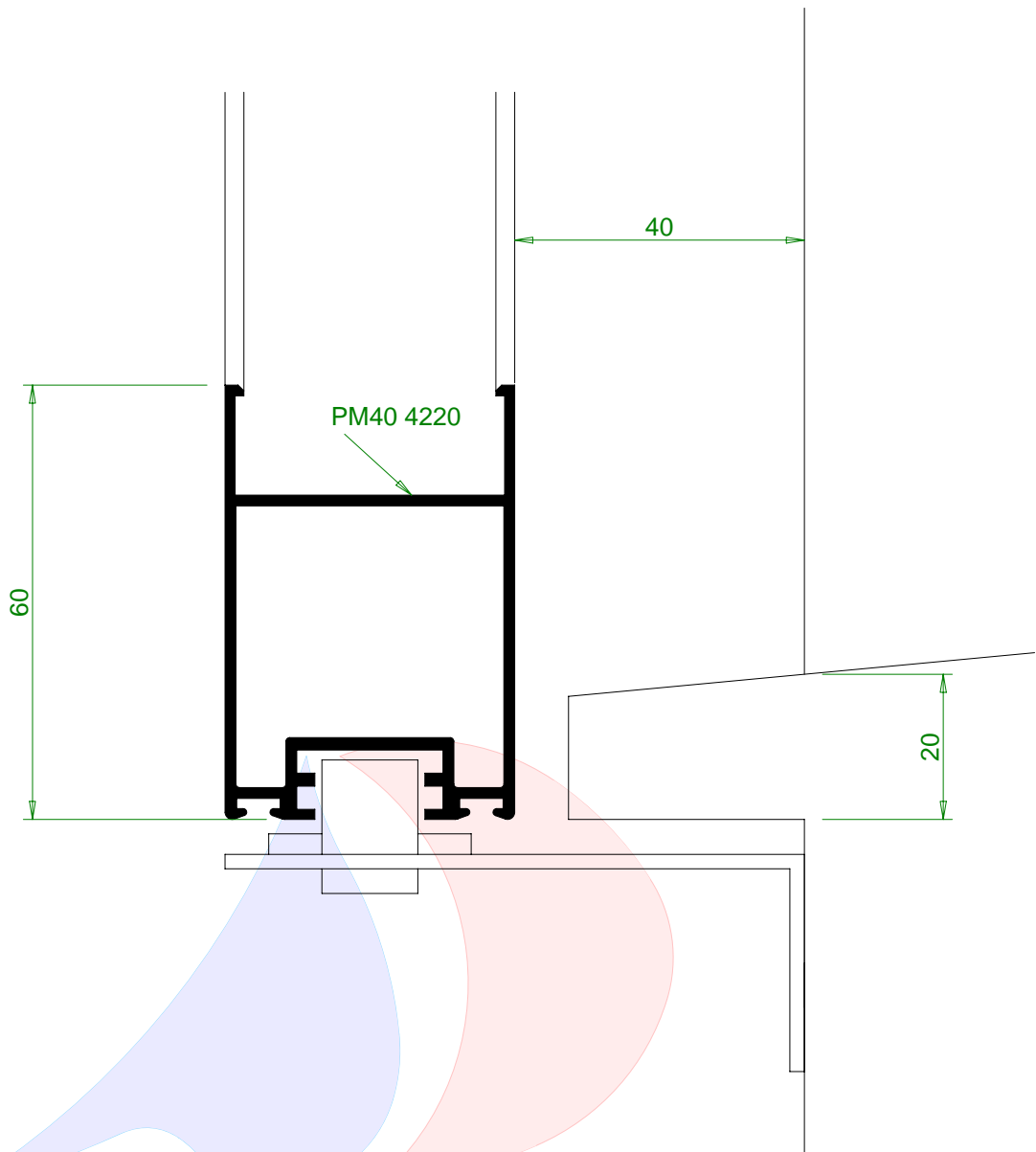

dimac  
AD Sistemas

mallorquina

# S19 -a suelo-

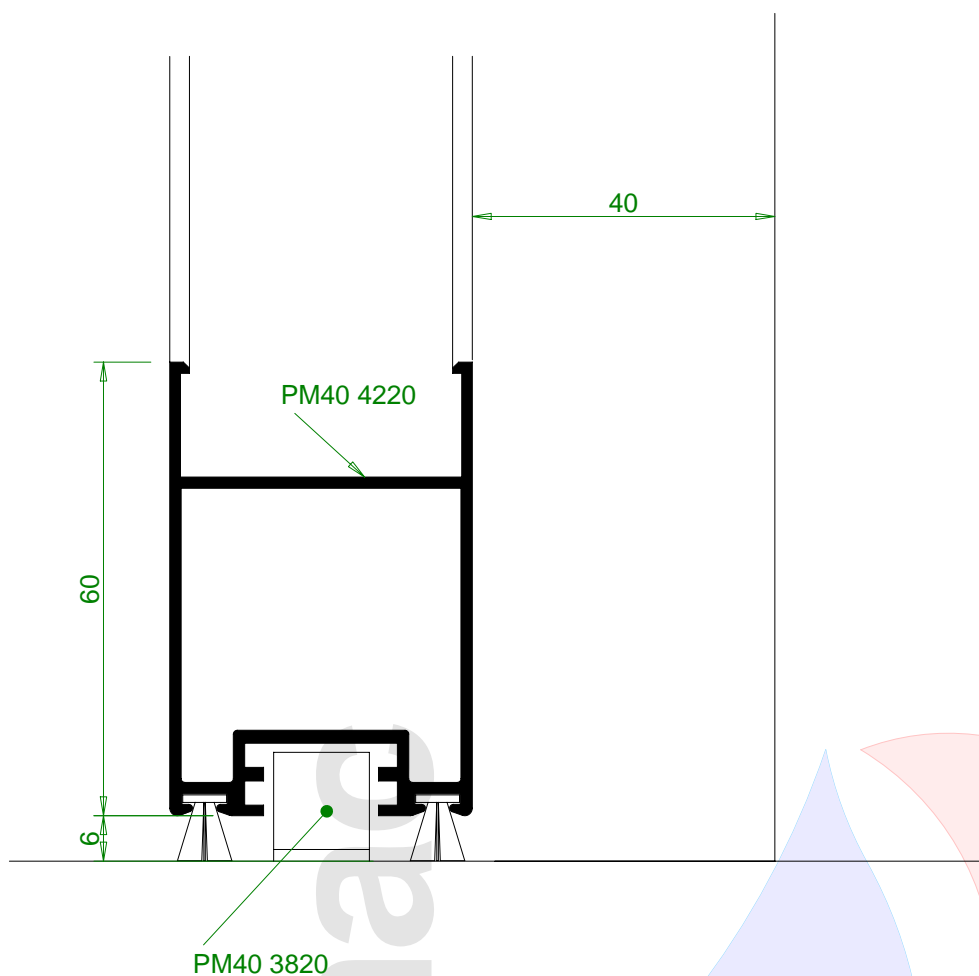
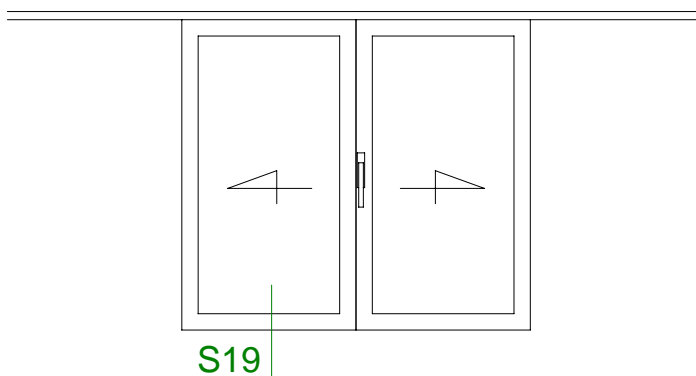

43

44

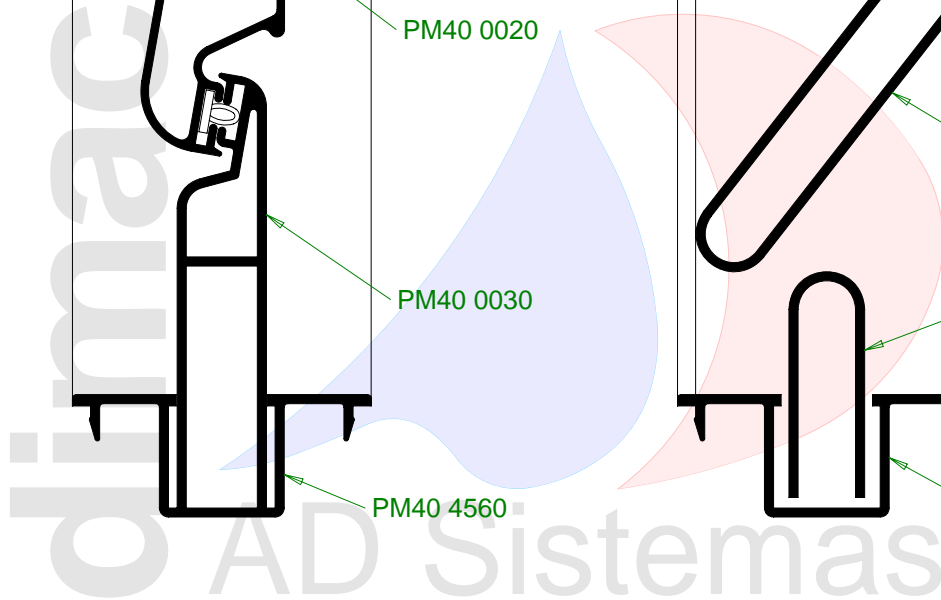
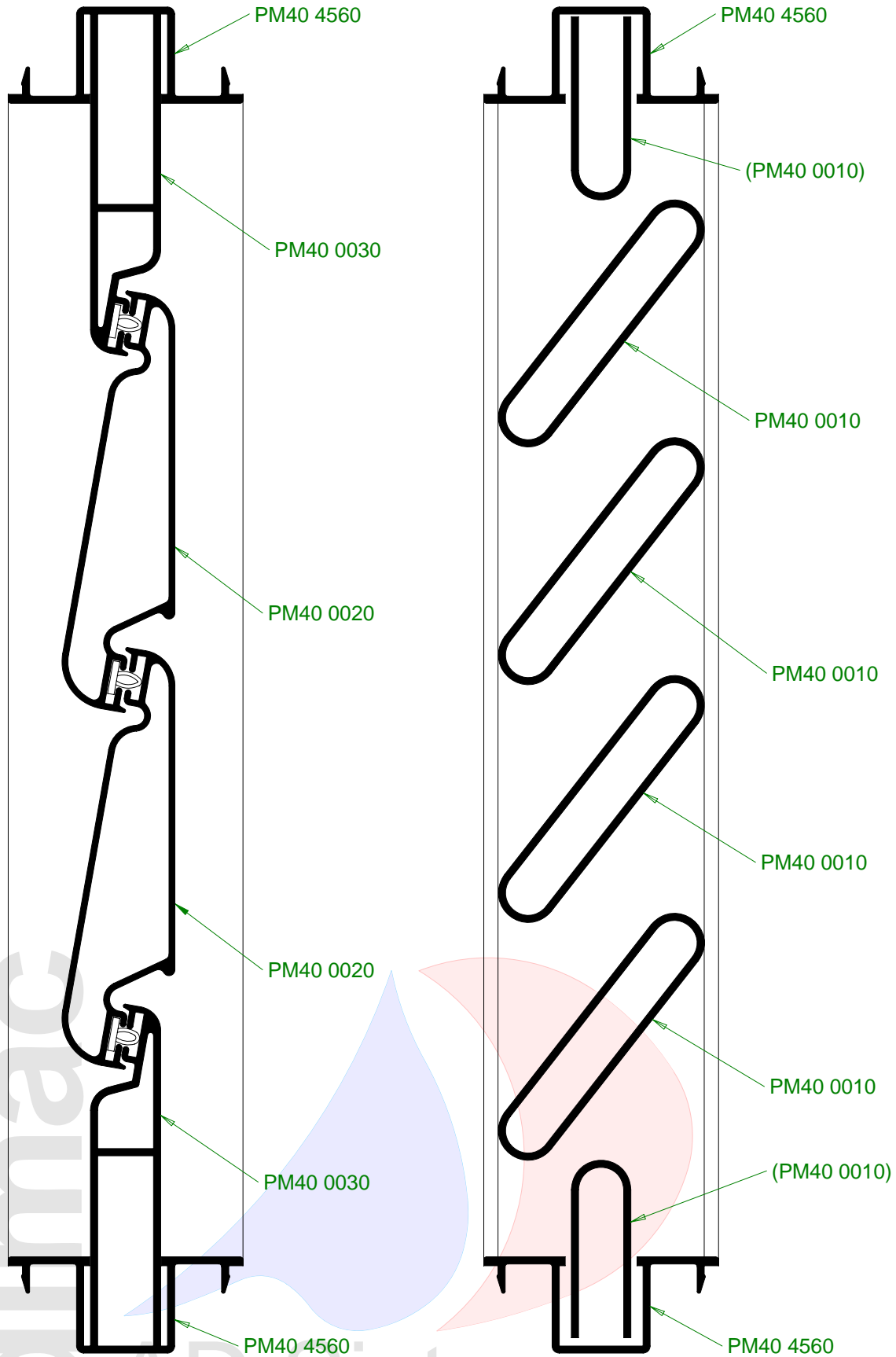

secciones verticales de hoja

**SV1**

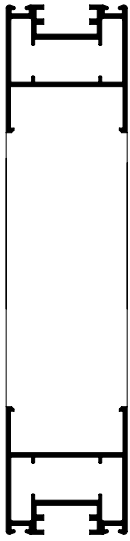

**SV2**

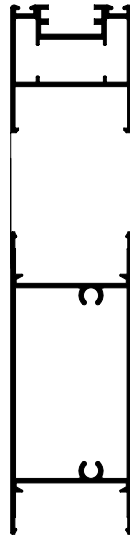

**SV3**

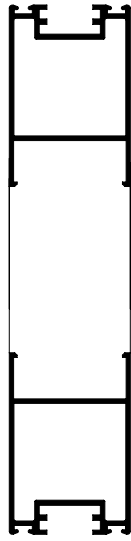

**SV4**

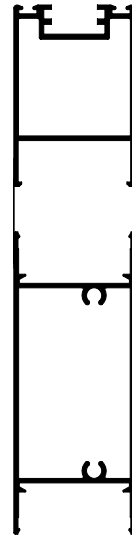

**SV5**

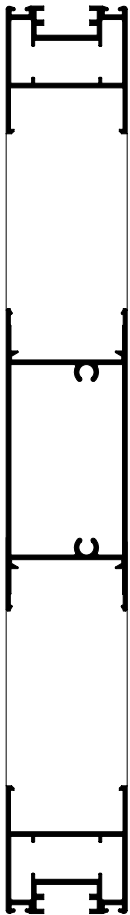

**SV6**

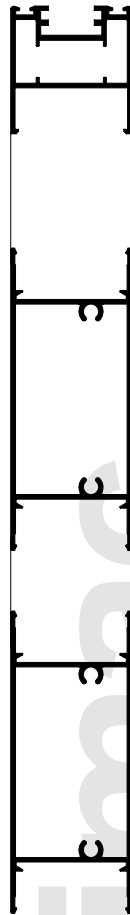

**SV7**

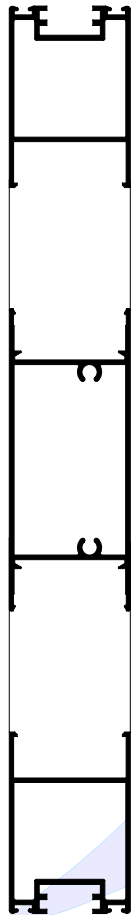

**SV8**

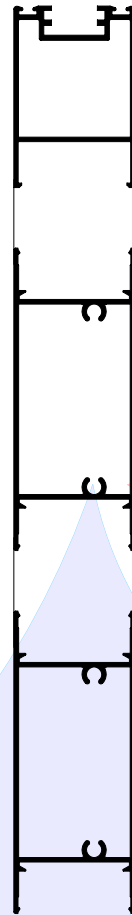

45



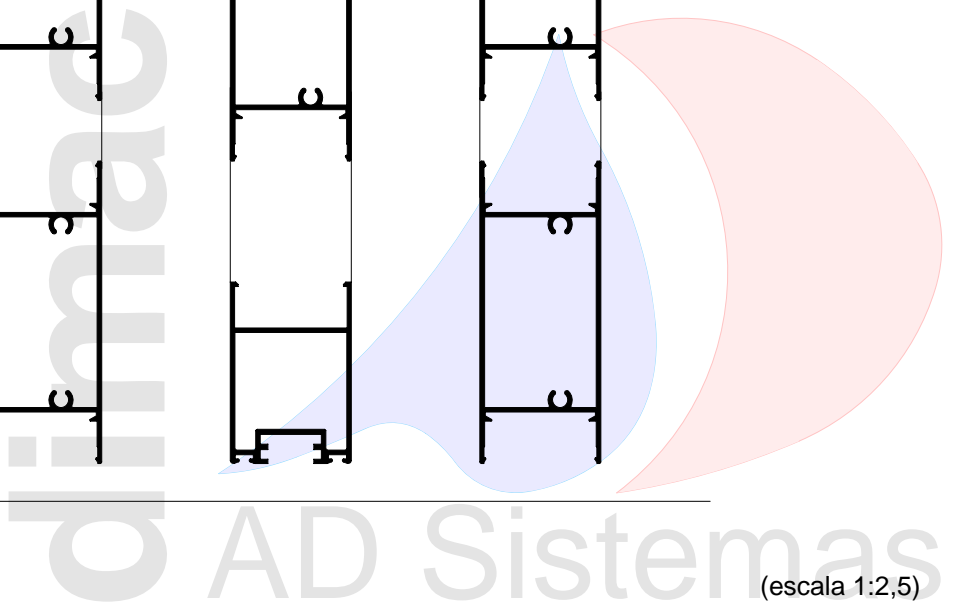









mallorquina









(escala 1:2,5)

## CORTE DE MARCOS:

### 1. Practicable:

- 1.1. **Marco normal:** (PM404110) 2 unid L  2 unid H 
- 1.2. **Marco con solape:** (PM404112) 2 unid L+60  2 unid H+60 
- 1.3. **Marco con solape, retornado con marco normal:** (PM404112) 1 unid L+60   
2 unid H+60  (PM404110) 1 unid L 
- 1.4. **Marco normal sin retornar:** (PM404110) 1 unid L  2 unid H  
- 1.5. **Marco con solape y sin retornar:** (PM404112) 1 unid L+60   
2 unid H+30  

### 2. Plegable

- 2.1. **Con guía inferior sobrepuesta:** 1 unid guía sup (PM404103) L   
2 unid marco lateral (PM404110) H-56   
1 unid guía inf sobrepuesta (PM404103) L 
- 2.2. **Con guía inferior empotrada:** 1 unid guía sup (PM404103) L   
2 unid marco lateral (PM404110) H-38   
1 unid guía inf empotrada (PM404102) L 

### 3. Corredera

- 3.1. **Una hoja:** *se aconseja suministrar (para ajustar en obra) las guías superiores e inferiores (si corresponde) al ancho de luz mas 200mm (L+200). Además suministrar el tubo 80x40, el marco PM404110 y el batiente PM404240 a la altura de luz mas 150mm (H+150).*
- 3.2. **Dos hojas:** *se aconseja suministrar (para ajustar en obra) las guías superiores e inferiores (si corresponde) al ancho de luz mas 400mm (L+400).*

## CORTE DE HOJAS:

### 1. Practicable:

#### 1.1. Altura (H)

- 1.1.1. **Sobre marco retornado:** X unidades H-72  $\backslash \_ /$  (X = num hojas \*2)  
Hoja PM404210 secciones vert SV01, SV05  
Hoja PM404220 secciones vert SV03, SV07  
Además de 1 unid PM404240 H-72  $| \_ |$
- 1.1.2. **Sobre marco sin retornar:** X unidades H-44  $\backslash \_ /$  (X = num hojas \*2)  
Hoja PM404210 secciones vert SV01, SV05  
Hoja PM404220 secciones vert SV03, SV07  
Además de 1 unid PM404240 H-44  $| \_ |$
- 1.1.3. **Sobre marco retornado, con zócalo inferior:**  
X unidades H-72  $| \_ / \_ |$  (X = num hojas \*2)  
Hoja PM404210 secciones vert SV02, SV06  
Hoja PM404220 secciones vert SV04, SV08  
Además de 1 unid PM404240 H-72  $| \_ |$
- 1.1.4. **Sobre marco sin retornar, con zócalo inferior:**  
X unidades H-44  $| \_ / \_ |$  (X = num hojas \*2)  
Hoja PM404210 secciones vert SV02, SV06  
Hoja PM404220 secciones vert SV04, SV08  
Además de 1 unid PM404240 H-44  $| \_ |$

#### 1.2. Anchura:

- 1.2.1. **Hoja retornada** (será opcional en todos los casos el travesaño intermedio a la misma medida de la hoja menos 54mm [hoja pequeña] o menos 90mm [hoja ancha])
- 1.2.1.1. UNA hoja: 2 unid L-76  $\backslash \_ /$
- 1.2.1.2. DOS hojas: 4 unid (L-82)/2  $\backslash \_ /$
- 1.2.1.3. TRES hojas: 4 unid  $((L-88)/3)+10 \backslash \_ /$   
2 unid  $((L-88)/3)-20 \backslash \_ /$
- 1.2.1.4. CUATRO hojas: 4 unid  $((L-94)/4)+15 \backslash \_ /$   
4 unid  $((L-88)/4)-15 \backslash \_ /$
- 1.2.2. **Hoja con zócalo inferior** (será opcional en todos los casos el travesaño intermedio a la misma medida de la hoja menos 54mm [hoja pequeña] o menos 90mm [hoja ancha])
- 1.2.2.1. UNA hoja: 1 unid L-76  $\backslash \_ /$   
1 zócalo inferior a la misma medida de la hoja menos 54mm [hoja pequeña] o menos 90mm [hoja ancha]
- 1.2.2.2. DOS hojas: 2 unid (L-82)/2  $\backslash \_ /$   
2 zócalos inferiores a la misma medida de la hoja menos 54mm [hoja pequeña] o menos 90mm [hoja ancha]
- 1.2.2.3. TRES hojas: 2 unid  $((L-88)/3)+10 \backslash \_ /$   
1 unid  $((L-88)/3)-20 \backslash \_ /$   
3 zócalos inferiores a la misma medida de cada hoja menos 54mm [hoja pequeña] o menos 90mm [hoja ancha]
- 1.2.2.4. CUATRO hojas: 2 unid  $((L-94)/4)+15 \backslash \_ /$   
2 unid  $((L-88)/4)-15 \backslash \_ /$   
4 zócalos inferiores a la misma medida de cada hoja menos 54mm [hoja pequeña] o menos 90mm [hoja ancha]

## CORTE DE HOJAS:

### 2. Plegable:

#### 2.1. Altura (H)

2.1.1. **Sobre guía inf sobrepuesta:** X unidades H-68  $\backslash \_ /$  (X = num hojas \*2)

Hoja PM404210 secciones vert SV01, SV05

Hoja PM404220 secciones vert SV03, SV07

Además de 1 unid PM404240 H-68  $| \_ |$

2.1.2. **Sobre guía inf empotrada:** X unidades H-50  $\backslash \_ /$  (X = num hojas \*2)

Hoja PM404210 secciones vert SV01, SV05

Hoja PM404220 secciones vert SV03, SV07

Además de 1 unid PMR4240 H-50  $| \_ |$

2.1.3. **Sobre guía inf sobrepuesta, con zócalo inferior:**

X unidades H-68  $| \_ / \_ |$  (X = num hojas \*2)

Hoja PM404210 secciones vert SV02, SV06

Hoja PM404220 secciones vert SV04, SV08

Además de 1 unid PM404240 H-68  $| \_ |$

2.1.4. **Sobre guía inf empotrada, con zócalo inferior:**

X unidades H-50  $| \_ / \_ |$  (X = num hojas \*2)

Hoja PM404210 secciones vert SV02, SV06

Hoja PM404220 secciones vert SV04, SV08

Además de 1 unid PM404240 H-50  $| \_ |$

#### 2.2. Anchura (L):

2.2.1. **Hoja retornada** (será opcional en todos los casos el travesaño intermedio a la misma medida de la hoja menos 54mm [hoja pequeña] o menos 90mm [hoja ancha])

XY = numero de hojas plegables

2\*XY unidades a  $(L - (((XY - 1) * 6) + 76)) / XY \backslash \_ /$

2.2.2. **Hoja con zócalo inferior** (será opcional en todos los casos el travesaño intermedio a la misma medida de la hoja menos 54mm [hoja pequeña] o menos 90mm [hoja ancha])

XY = numero de hojas plegables

XY unidades a  $(L - (((XY - 1) * 6) + 76)) / XY \backslash \_ /$

XY zócalos inferiores a la misma medida de cada hoja menos 54mm [hoja pequeña] o menos 90mm [hoja ancha]

### 3. Corredera

#### 3.1. Altura (H = hueco obra)

3.1.1. **Guía inferior sobrepuesta**

X unid H-32  $\backslash \_ /$  (X = num hojas \*2)

3.1.2. **Guía inferior empotrada**

X unid H-14  $\backslash \_ /$  (X = num hojas \*2)

3.1.3. En todos los casos añadir X unid perfil PM404105 a la misma longitud que las hojas

#### 3.2. Anchura (L = hueco obra)

3.2.1. UNA hoja: 2 unid L-20  $\backslash \_ /$

3.2.2. DOS hojas: 4 unid  $(L-10)/2 \backslash \_ /$

