

SERIE ABATIBLE **THERMIA AF35**

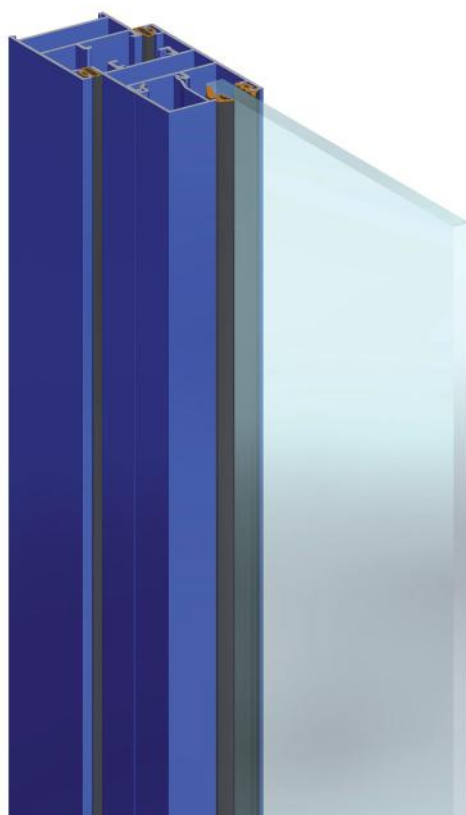

Diseño. Confort. Silencio.

THERMIA[®]
B A R C E L O N A

PERMEABILIDAD AL AIRE según EN 12207 - Mercado CE según EN 14351-1:2006 (E.1)

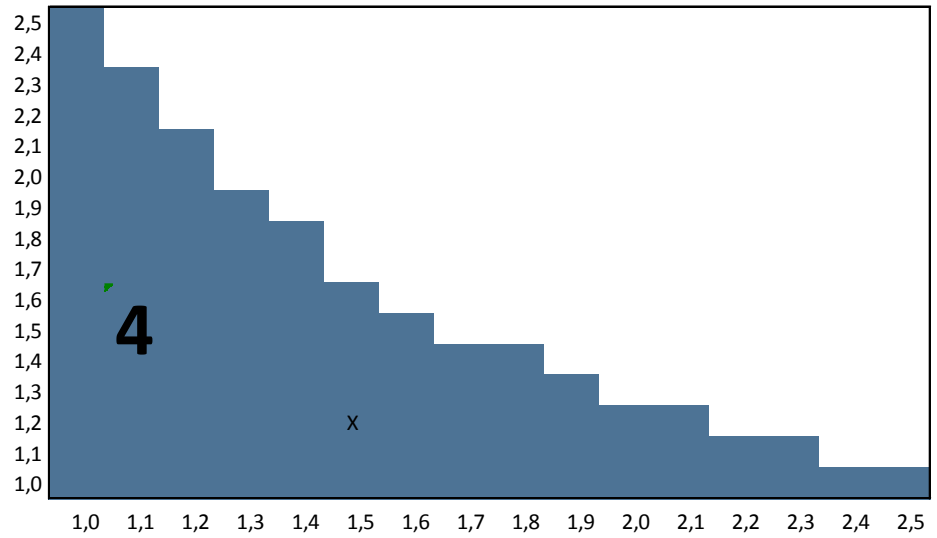

ESTANQUIDAD AL AGUA según EN 12208 - Mercado CE según EN 14351-1:2006 (E.1)

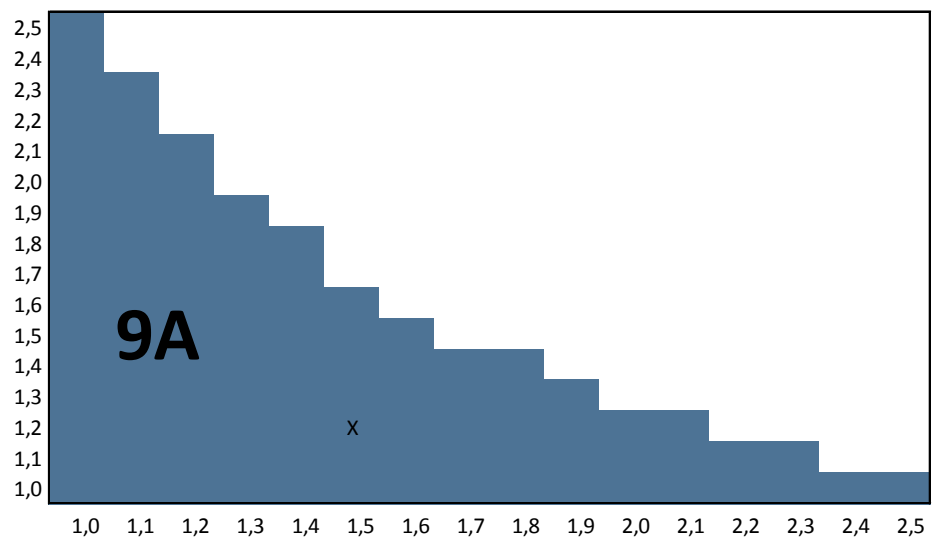

RESISTENCIA AL VIENTO según EN 12210 - Mercado CE según EN 14351-1:2006 (E.1)

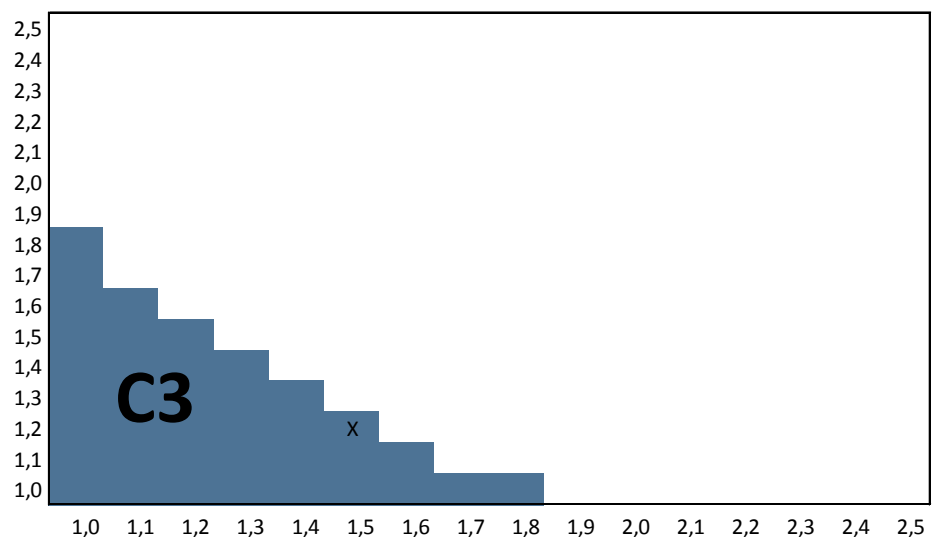

Resultados obtenido del informe oficial num.: 15/10169-753 según ensayos realizados en Applus, y en base al Anexo E de la norma EN 14351-1:2006.

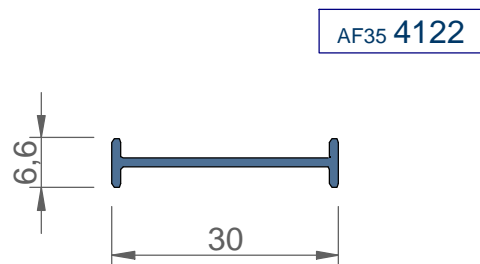
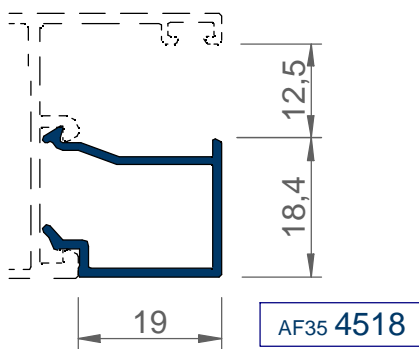
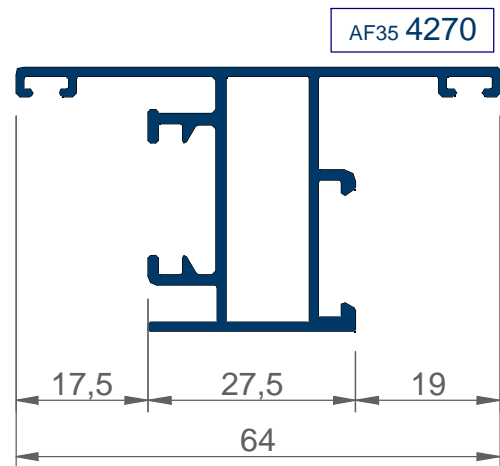
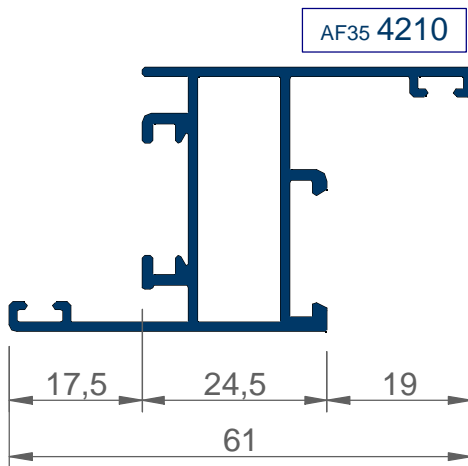
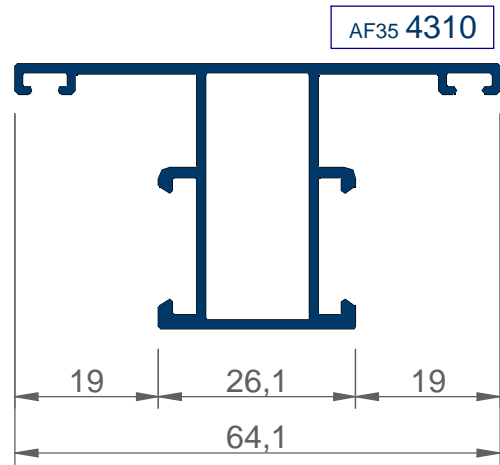
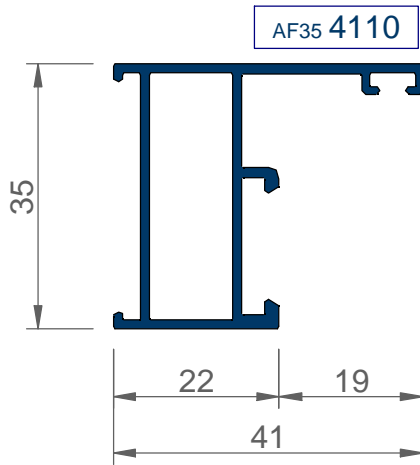

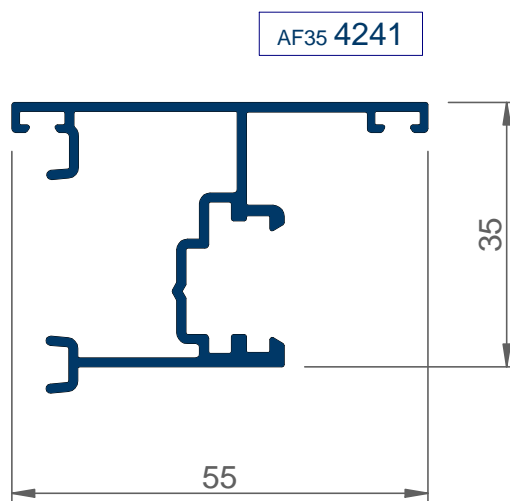
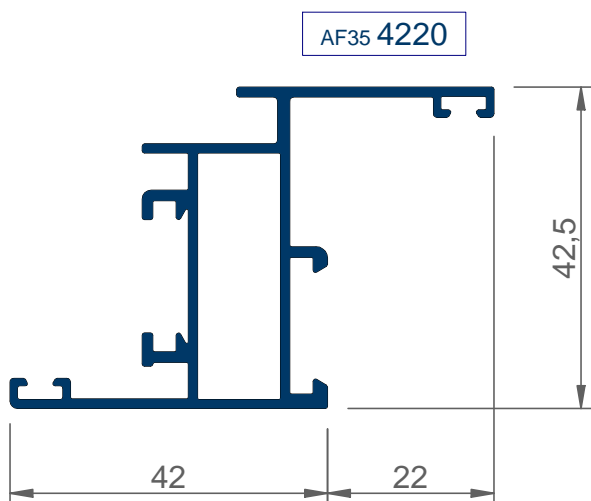

junquillos altura 22

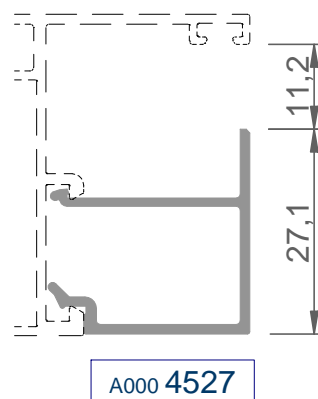
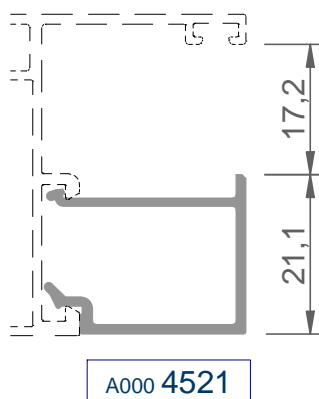
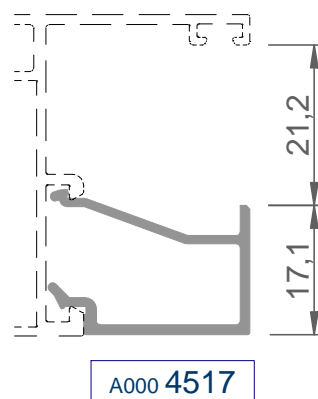
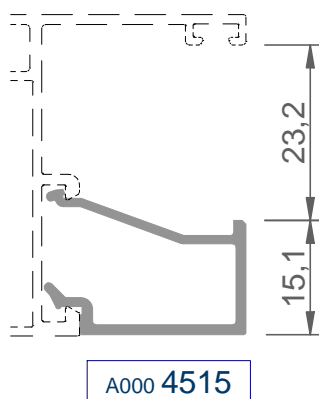
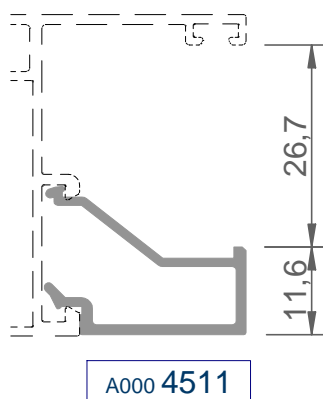

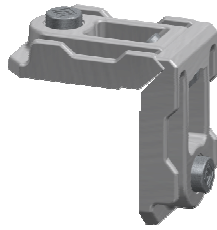

A000 2112
escuadra



A000 2120
unión travesaño



A000 2320
junta cierre

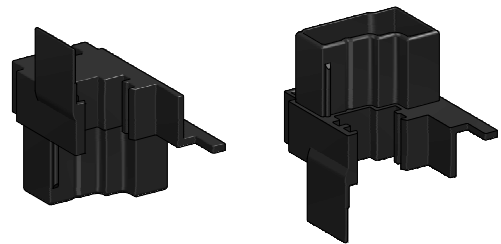

AF35 2340
juego tapas inversora



A000 2351
junta exterior (2mm)



A000 2353
junta cuña (de 3 a 5mm)



A000 2355
junta cuña (de 5 a 7mm)

Para accesorios de Maniobra consultar catálogo específico

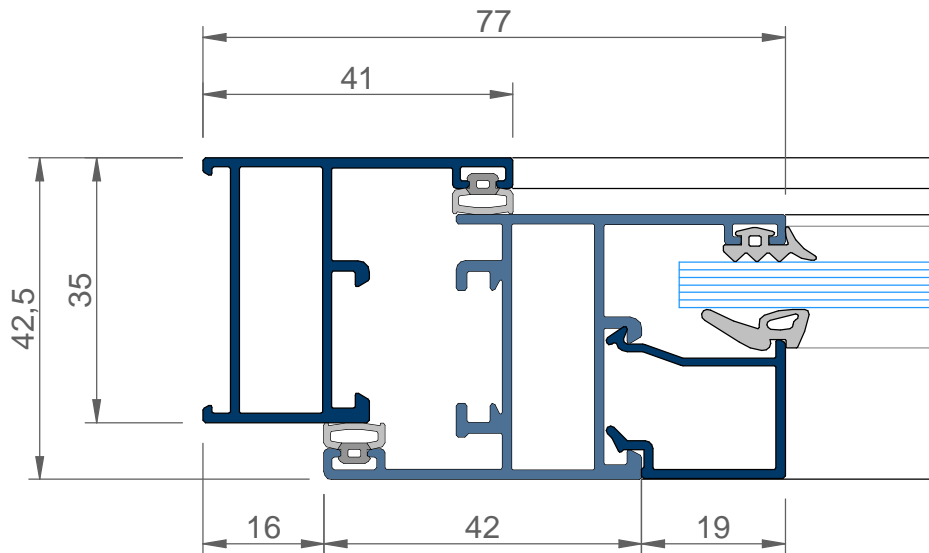

apertura interior

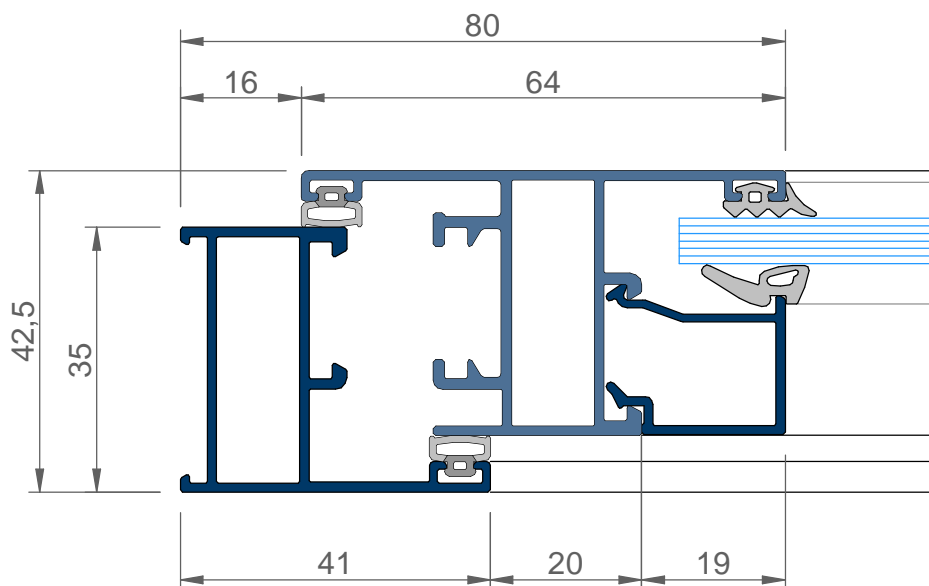

apertura exterior

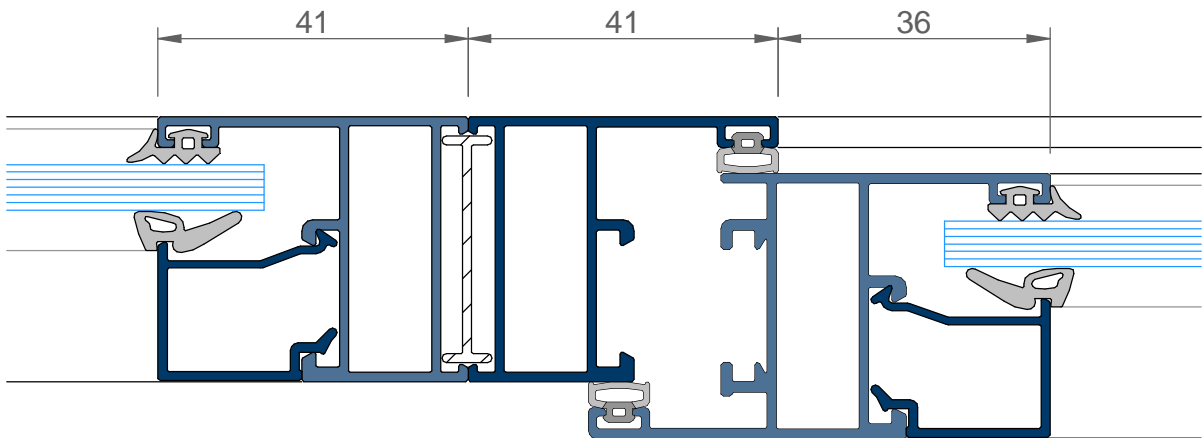

apertura interior

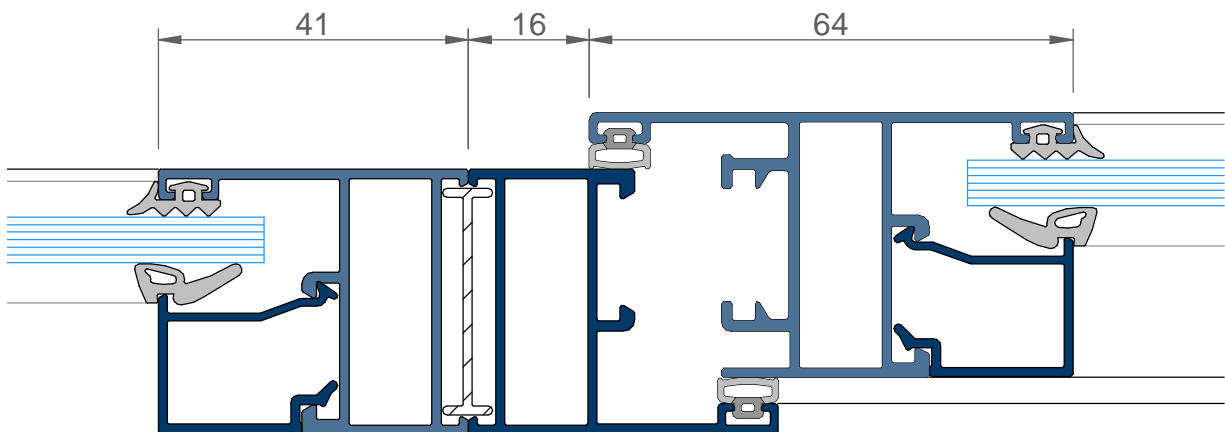

apertura exterior

con junquillos alt 22mm

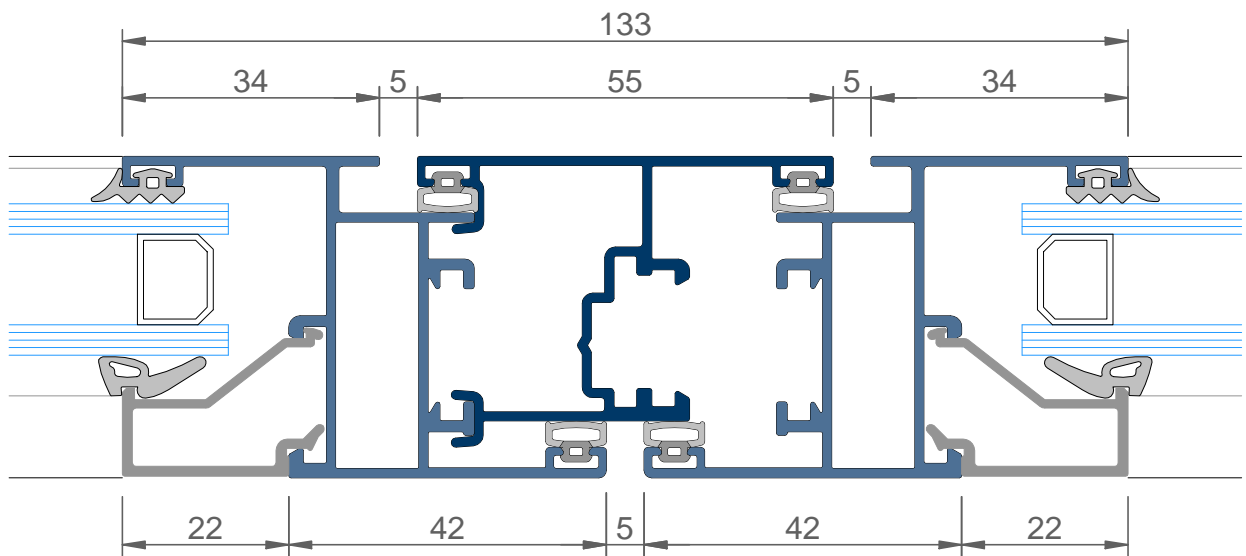
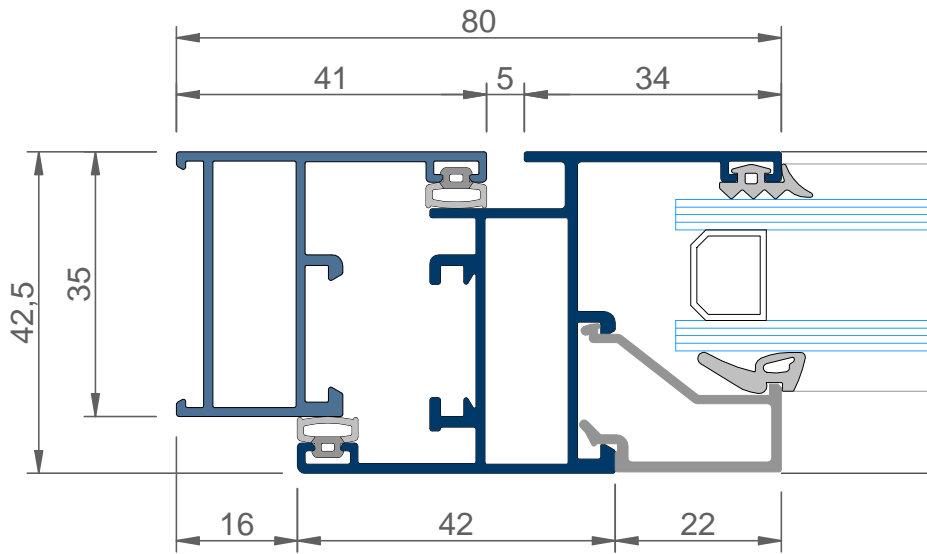

combinada con **CF22**

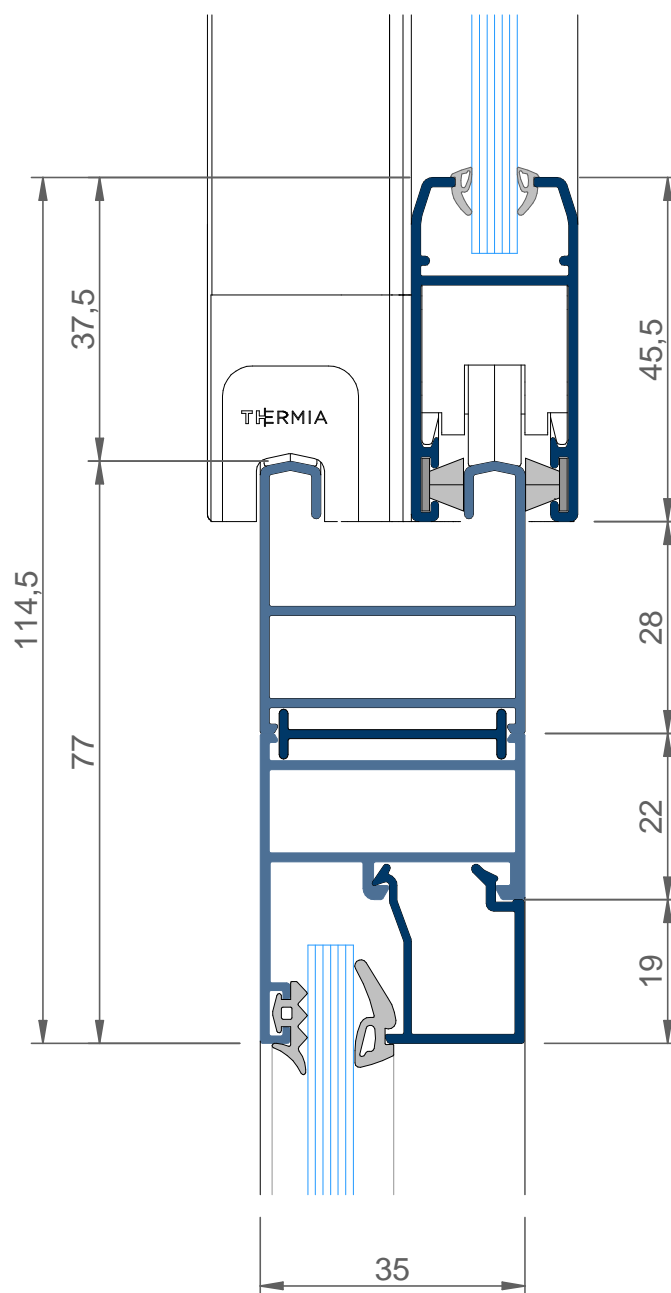
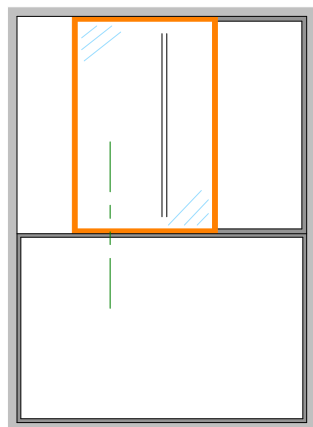

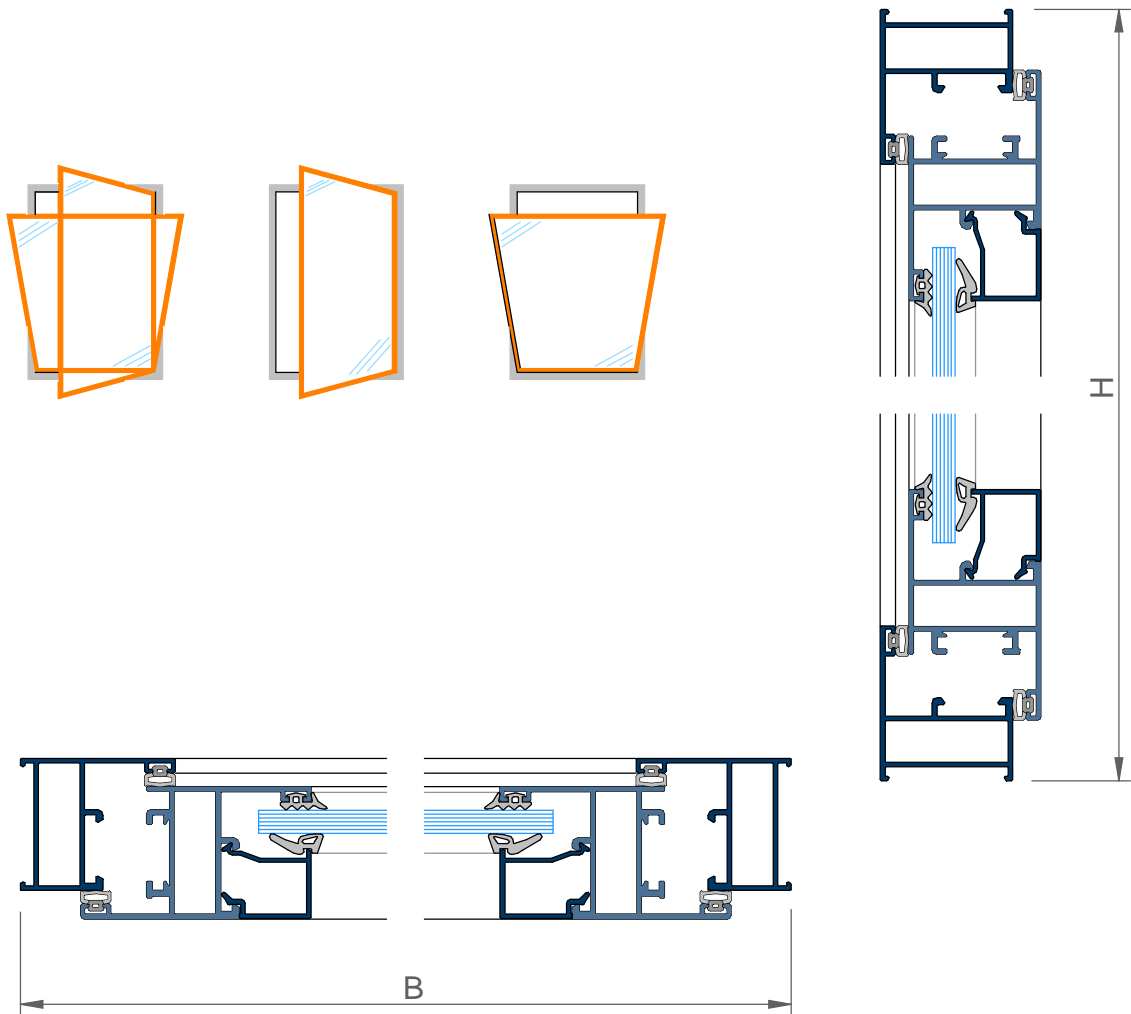

COD	DESCRIPCIÓN	CANT	FORMULA
AF35 4110	marco horizontal	2	B
AF35 4110	marco vertical	2	H
AF35 4210	hoja horizontal	2	B-33
AF35 4210	hoja vertical	2	H-33
AF35 4518	junquillo horizontal	2	B-116
AF35 4518	junquillo vertical	2	H-154
	vidrio	1	B-125 x H-125
A000 2112	escuadras	8	
A000 2320	junta cierre	4	B+H
A000 2351	junta ext vidrio	2	B+H
A000 2....	junta int vidrio	2	B+H

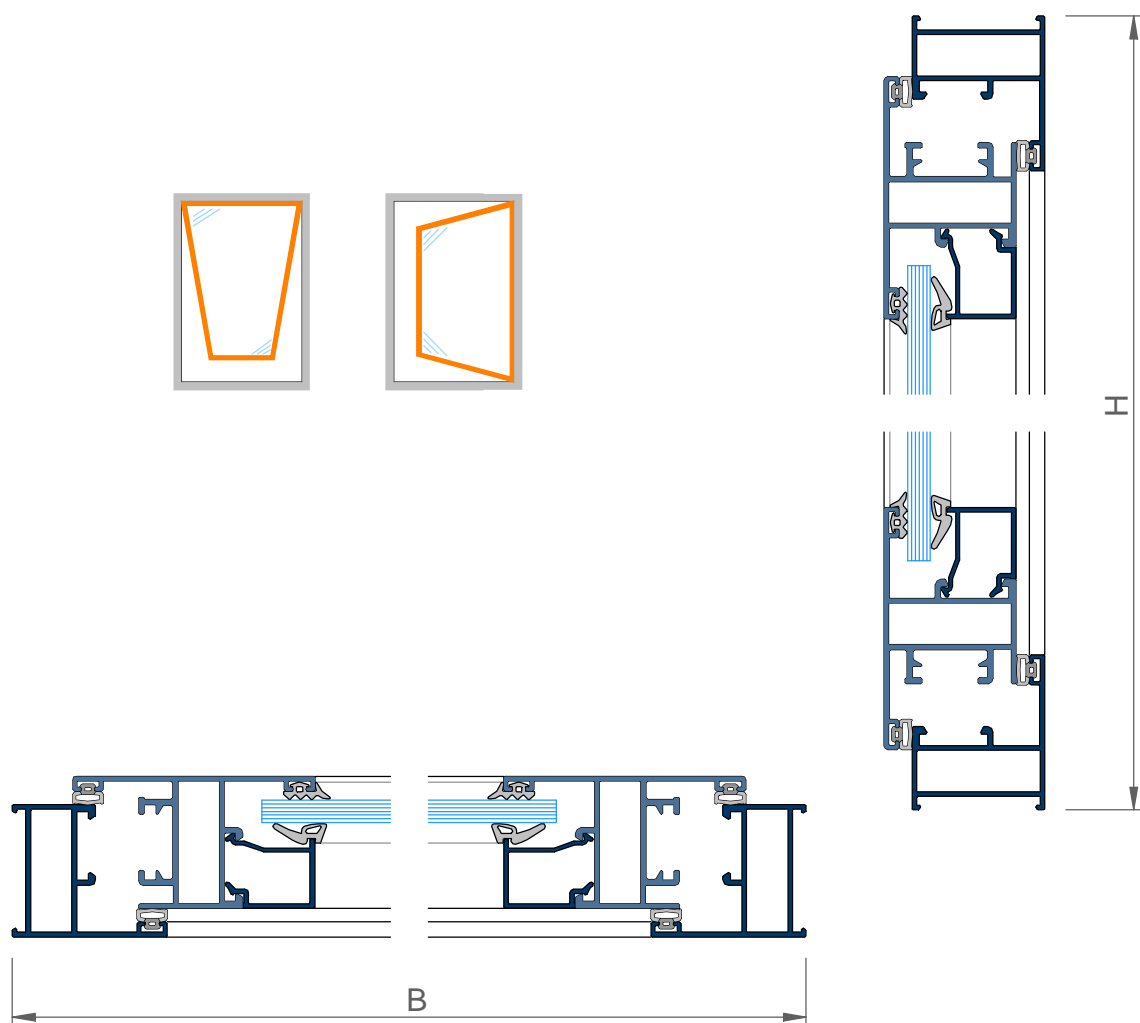

COD	DESCRIPCIÓN	CANT	FORMULA
AF35 4110	marco horizontal	2	B
AF35 4110	marco vertical	2	H
AF35 4270	hoja EXT horizontal	2	B-33
AF35 4270	hoja EXT vertical	2	H-33
AF35 4518	junquillo horizontal	2	B-122
AF35 4518	junquillo vertical	2	H-160
vidrio		1	B-132 x H-132
A000 2112	escuadras	8	
A000 2320	junta cierre	4	B+H
A000 2351	junta ext vidrio	2	B+H
A000 2....	junta int vidrio	2	B+H

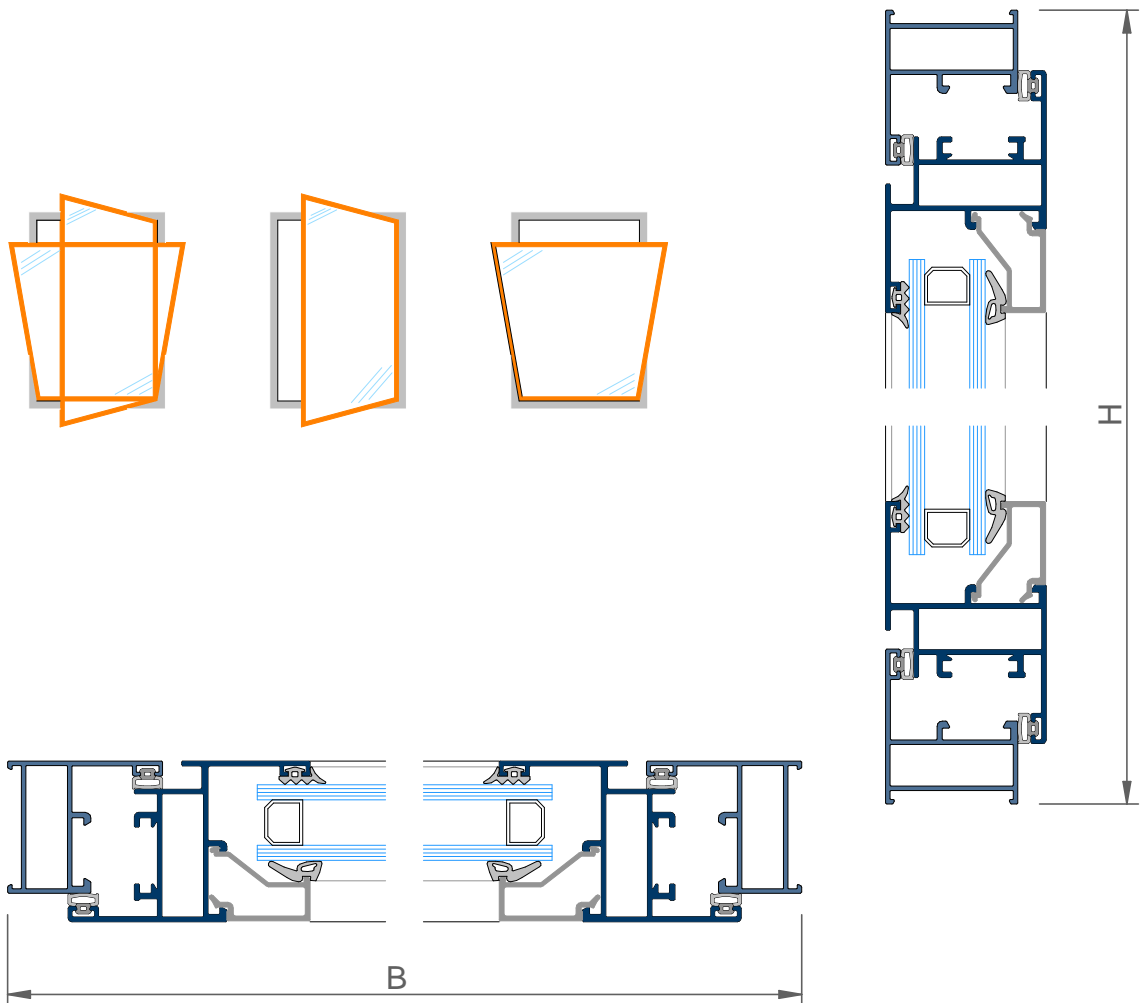

COD	DESCRIPCIÓN	CANT	FORMULA
AF35 4110	marco horizontal	2	B
AF35 4110	marco vertical	2	H
AF35 4220	hoja EXT horizontal	2	B-33
AF35 4220	hoja EXT vertical	2	H-33
A000 45xx	junquillo horizontal	2	B-116
A000 45xx	junquillo vertical	2	H-160
vidrio		1	B-135 x H-135
A000 2112	escuadras	8	
A000 2320	junta cierre	4	B+H
A000 2351	junta ext vidrio	2	B+H
A000 2...	junta int vidrio	2	B+H

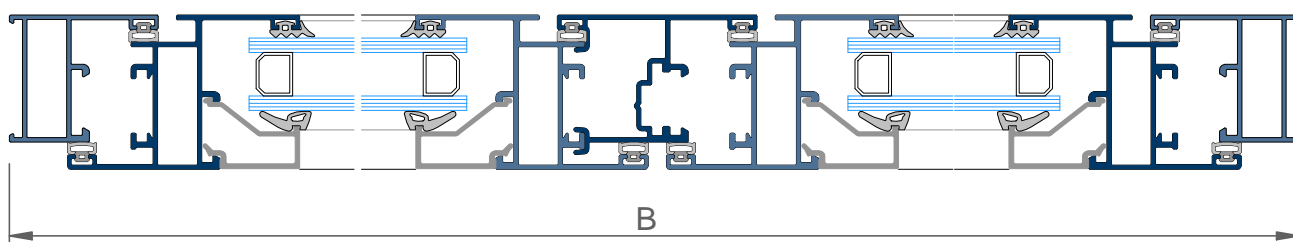
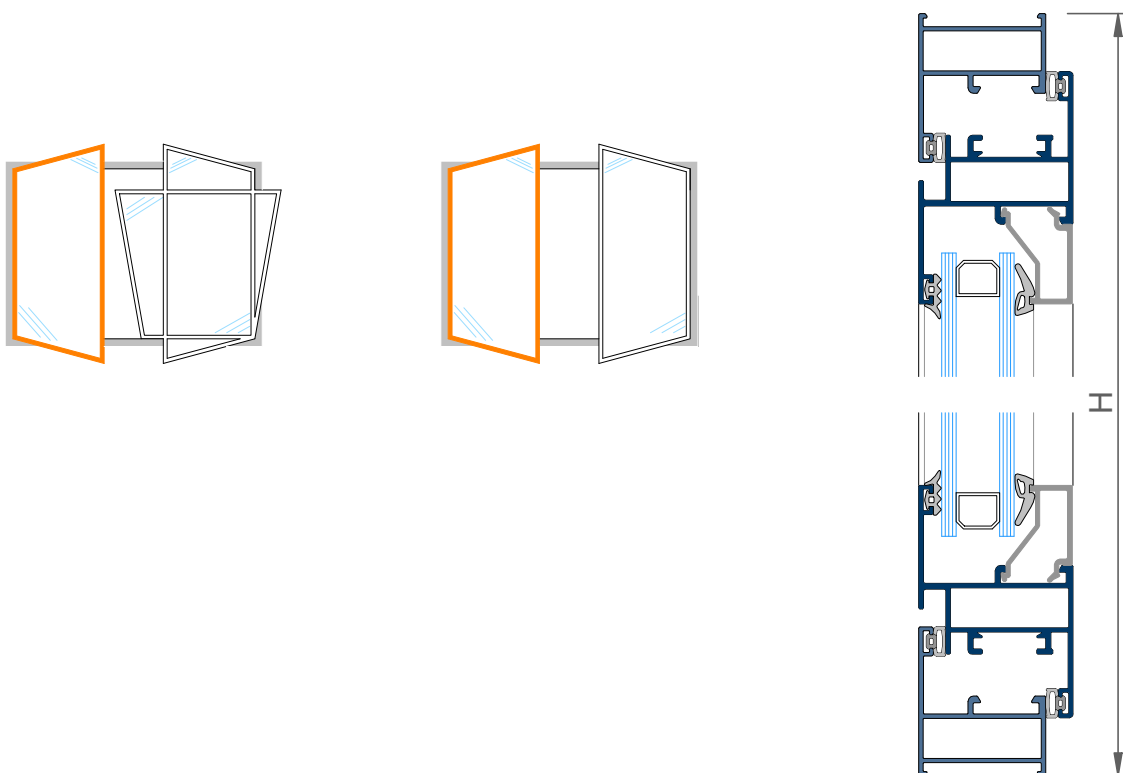

COD	DESCRIPCIÓN	CANT	FORMULA
AF35 4110	marco horizontal	2	B
AF35 4110	marco vertical	2	H
AF35 4220	hoja horizontal	4	$(B-38)/2$
AF35 4220	hoja vertical	4	H-33
AF35 4241	inversor doble hoja	1	H-96
A000 45xx	junquillo horizontal	4	$(B-204)/2$
A000 45xx	junquillo vertical	4	H-154
	vidrio	2	$(B-245)/2 \times H-135$
A000 2112	escuadras	12	
A000 2320	junta cierre	1	$4B + 8H$
A000 2351	junta ext vidrio	1	$2B + 4H$
A000 2....	junta int vidrio	1	$2B + 4H$
AF35 2340	juego tapas inversor	1	

